



INTEGRATION OF ELECTRIC VEHICLES CHARGING INFRASTRUCTURE WITH DISTRIBUTION GRID: GLOBAL REVIEW, INDIA'S GAP ANALYSES AND WAY FORWARD

REPORT 2

INTERNATIONAL REVIEW ON INTEGRATION OF ELECTRIC VEHICLES CHARGING INFRASTRUCTURE WITH DISTRIBUTION GRID



Led by IIT Bombay



Disclaimer

While care has been taken in the collection, analysis, and compilation of the data, Deutsche Gesellschaft für Internationale Zusammenarbeit (GIZ) GmbH does not guarantee or warrant the accuracy, reliability, completeness or currency of the information in this publication. The mention of specific companies or certain projects/products does not imply that they are endorsed or recommended by the members of this publication. The information provided is without warranty of any kind. GIZ and the authors accept no liability whatsoever to any third party for any loss or damage arising from any interpretation or use of the document or reliance on any views expressed herein.

INTEGRATION OF
ELECTRIC VEHICLES CHARGING
INFRASTRUCTURE WITH DISTRIBUTION GRID:
**GLOBAL REVIEW, INDIA'S GAP ANALYSES
AND WAY FORWARD**

REPORT 2

INTERNATIONAL REVIEW
ON INTEGRATION OF ELECTRIC VEHICLES CHARGING
INFRASTRUCTURE WITH DISTRIBUTION GRID

Acknowledgement

This publication has been prepared by Indian Institute of Technology Bombay (IIT Bombay) in collaboration with Florence School of Regulations Global (FSR Global), as a part of the Nationally Determined Contributions – Transport Initiative for Asia (NDC-TIA) initiative. NDC-TIA is implemented by the Deutsche Gesellschaft für Internationale Zusammenarbeit GmbH (GIZ) and funded by the German Federal Ministry for the Environment, Nature Conservation and Nuclear Safety (BMU) under its International Climate Initiative (IKI).

Authors:

Prof. Zakir Rather (IIT Bombay), Mr. Angshu Nath (IIT Bombay) and Prof. Rangan Banerjee (IIT Bombay), and Ms. Christine Jutta (FSR Global)

Contributors:

Mr. Soudipan Maity (IIT Bombay), Ms. Dhanuja Lekshmi (IIT Bombay), Mr. Swapnil Gandhi (IIT Bombay) and Ms. Swetha Bhagwat (FSR Global)

Advisors:

Prof. Liana Cipcigan (Cardiff University, UK), Prof. Qiuwei Wu (Technical University of Denmark (DTU), Denmark), Prof. Pablo Frias (IIT Comillas, Spain)

Reviewers:

Ms. Sahana L (GIZ), Ms. Shweta Kalia (GIZ), Mr. Sudhanshu Mishra (GIZ), Mr. Sushovan Bej (GIZ), Mr. Siddharth Sinha (NITI Aayog), Mr. Vijay Kumar (NITI Aayog), Mr. Madhav Sharma (NITI Aayog), Mr. Amit Bhatt (WRI) and Dr. Nibedita Dash (ICCT)

Responsible:

Dr. Indradip Mitra
Country Coordinator for NDC-TIA India Component (GIZ)

अमिताभ कांत
Amitabh Kant
मुख्य कार्यकारी अधिकारी
Chief Executive Officer



भारत सरकार
नीति आयोग, संसद मार्ग,
नई दिल्ली-110 001
Government of India
NATIONAL INSTITUTION FOR TRANSFORMING INDIA
NITI Aayog, Parliament Street,
New Delhi-110001

Tel. : 23096576, 23096574 Fax : 23096575
E-mail : ceo-niti@gov.in, amitabh.kant@nic.in

FOREWORD

With the second-largest road network in the world, India's road transport contributes towards nearly 64% of the country's overall goods movement and caters to around 90% of India's total passenger traffic. This provides a huge opportunity to decarbonize the transport sector but there are also challenges. Government of India has taken proactive measures towards fostering a clean, connected, shared and cutting-edge transportation system by providing policy and regulatory support.

As India embarks on this ambitious journey towards sustainable mobility, a robust charging infrastructure will play a pivotal role. It must be understood that sector coupling between the energy and transport sectors is vital for e-mobility. With the growing number of EVs, the need for development of large network of charging infrastructure will only increase in the future. To support deployment of charging infrastructure in the country, the Government of India has allocated a total fund of INR 1000 Crore under the FAME II scheme. Under public procurement, Department of Heavy Industry (DHI) has sanctioned 2,636 EV Charging Stations, in 62 cities across 24 States/UTs and 1,544 such stations on highways under FAME II scheme. EV charging is a delicensed activity in India and the Ministry of Power (MoP) has published revised guidelines for Charging infrastructure for Electric Vehicles to facilitate the deployment of charging infrastructure. Apart from this, several states have announced targets for EV deployment including special EV tariff to incentivize EV charging in India. For the uptake of EV adoption in India, a major challenge of integrating the charging infrastructure with the electrical network needs to be tackled. The continued development of EV charging infrastructure and its integration will depend, among other things, on policy and regulatory environment, which must also account for grid stability.

I am glad to know that the Deutsche Gesellschaft für Internationale Zusammenarbeit GmbH (GIZ) has initiated a study focused on EV charging infrastructure, related policy and regulatory measures, grid integration of EVs, critical international review from eight countries, and way forward for smooth integration of EV charging infrastructure with the Indian grid.

I congratulate GIZ for the publication of this report.

(Amitabh Kant)

Place- New Delhi
Dated- July, 2021



भारतीय प्रौद्योगिकी संस्थान मुंबई
पयई, मुंबई-400 076, भारत
Indian Institute of Technology Bombay
Powai, Mumbai-400 076, India

Office : 2572 3488, 2576 7001
Res. : 2572 3738, 2576 8000
Fax : 91-22-2572 3546
E-mail : director@iitb.ac.in
Website : www.iitb.ac.in

IIT Bombay

Subhasis Chaudhuri, Director
सुभासिस् चौधुरी, निदेशक



FOREWORD

At the COP21 conference in Paris in 2015, India targeted to reduce its carbon footprint for every dollar of economic output by 33 to 35% within 2030 from what it was in 2005. The transportation sector being one of the largest consumers of oil and gas and emitters of greenhouse gases globally, need to be addressed on a priority basis. Fuelled by reducing manufacturing and component prices of equipment and improving the affordability of personal vehicles, India has seen a rise in on-road automobiles. Naturally, the transportation sector in India is one of the largest consumers of crude oil and a significant source of GHG emissions, even from an international standpoint. In 2013, the National Electric Mobility Mission Plan (NEMMP) 2020 was envisioned with a vision and roadmap for faster adoption of hybrid and electric vehicles and boosting indigenous manufacturing to achieve national fuel security and mitigate the adverse environmental impacts of road transport vehicles. Government of India further brought out the ambitious Faster Adoption and Manufacturing of Hybrid and Electric Vehicles (FAME) scheme to promote electric mobility in the country. The first phase of the scheme (FAME-1) began in 2015 and was extended till 2019, following which the second phase (FAME-2) began which has recently been extended till 2024. The initiatives being taken also have a broader plan to de-license the charging infrastructure business and mandate specific guidelines and standards for charging infrastructure for electric vehicles. This would further strengthen the market of public charging infrastructure and warrant a roadmap for the development of charging infrastructure. Although the Government has taken decisive steps towards faster adoption of EVs, several challenges and gaps are existing in the Indian EV ecosystem that needs to be addressed.

The Nationally Determined Contribution-Transport Initiative for Asia (NDC-TIA), a joint project of seven organisations, on behalf of the German Federal Ministry for the Environment, Nature Conservation and Nuclear Safety (BMU) and with the engagement of China, India, and Vietnam is a welcome action. The project aims to promote a comprehensive strategy to decarbonising transport, i.e. a coherent system of effective policies coordinated among various sector ministries, civil society, and the private sector.

IIT Bombay is committed to playing a constructive role in achieving green and sustainable electrified transportation sector in the country. This specific study, "*Integration of Electric Vehicles Charging Infrastructure with Distribution Grid: Global review, India's Gap Analyses and Way Forward*", which is led by IIT Bombay, focuses on EV charging infrastructure, related policy and regulatory measures, grid integration of EVs, and the way forward for smooth EV adaption in the Indian EV ecosystem.

I would like to congratulate the authors, all the stakeholders involved, the reviewers, and the funding agencies contributing to the successful preparation of these reports.

Date: 02.08.2021
Place: Mumbai



(Subhasis Chaudhuri)

Table of Contents

LIST OF FIGURES.....	xii
LIST OF TABLES	xxi
ABBREVIATIONS	xxiii
CHAPTER 1. INTRODUCTION	1
1.1 BACKGROUND	1
1.2 ABOUT THIS STUDY.....	2
1.2.1 Aim of the Study.....	3
1.2.2 Objectives of the Study	3
1.2.3 Organization of the Study Reports	3
1.3 KEY TERMINOLOGIES.....	4
1.4 EV ECOSYSTEM REVIEW.....	6
1.5 GLOBAL EV CHARGING INFRASTRUCTURE	8
1.6 ELECTRIC VEHICLE INTEGRATION	11
1.7 ANALYTICAL FRAMEWORK.....	14
1.7.1 Enabling EV charging on supply-side.....	15
1.7.2 Enabling EV charging on demand-side.....	18
1.8 STAGES OF MARKET DEVELOPMENT.....	20
CHAPTER 2. UNITED KINGDOM.....	22
2.1 BACKGROUND FOR POLICY MAKING ENVIRONMENT	22
2.2 EV CHARGING INFRASTRUCTURE POLICIES AND REGULATIONS.....	24
2.3 EV CHARGING INFRASTRUCTURE.....	29
2.4 EV DEMAND STATUS.....	33
2.5 EV INTEGRATION	36
2.5.1 Installation of Charging points.....	38
2.5.2 Standards and Regulations for EV integration in the UK.....	40
2.5.3 Smart Charging.....	42
2.5.4 EV Aggregators.....	49
2.6 CASE STUDIES.....	50
2.6.1 My Electric Avenue	50
2.6.2 LV Connect and Manage	53
2.6.3 Electric Nation	62
2.6.4 Project Scirus	64

2.6.5	Electric Nation Vehicle to Grid.....	67
CHAPTER 3. UNITED STATES OF AMERICA		68
3.1	BACKGROUND FOR POLICY MAKING ENVIRONMENT	68
3.2	EV CHARGING INFRASTRUCTURE POLICIES AND REGULATIONS.....	68
3.3	EV CHARGING INFRASTRUCTURE.....	69
3.4	EV DEMAND STATUS.....	72
3.5	EV INTEGRATION.....	74
3.5.1	Ancillary Services.....	76
3.5.2	Frequency regulation service using EV fleet.....	82
3.6	CASE STUDIES.....	87
3.6.1	Los Angeles Air Force Base Vehicle-to-Grid Demonstration.....	87
3.6.2	JUMPSmartMaui (JSM).....	89
3.6.3	Smart Charging of EV and Storage supporting the Grid	92
3.6.4	Use of Electric Vehicle to reduce customer outages (improve reliability) and provide emergency backup power	96
3.6.5	Detailed analysis of DC Fast Charging.....	100
CHAPTER 4. CALIFORNIA, USA.....		105
4.1	BACKGROUND FOR EV POLICIES.....	105
4.2	EV CHARGING INFRASTRUCTURE POLICIES AND REGULATIONS.....	105
4.3	EV CHARGING INFRASTRUCTURE.....	109
4.4	EV DEMAND STATUS.....	110
4.5	EV INTEGRATION.....	111
4.5.1	EV Charging Tariffs	112
4.6	CASE STUDIES.....	116
4.6.1	EV Submetering	116
4.6.2	Optimal placement of DC Fast Charging stations.....	118
4.6.3	Electric Program Investment Charge (EPIC) – Vehicle to Home.....	121
4.6.4	INtelligent Electric VEhicle INtegration (INVENT).....	126
CHAPTER 5. THE NETHERLANDS		129
5.1	BACKGROUND FOR POLICY MAKING ENVIRONMENT	129
5.2	EV CHARGING INFRASTRUCTURE POLICIES AND REGULATIONS.....	130
5.3	EV CHARGING INFRASTRUCTURE.....	134
5.4	EV DEMAND STATUS.....	135
5.5	EV INTEGRATION.....	137

5.5.1	Installation of Private Chargers:.....	139
5.5.2	Requirements for Bidirectional Chargers.....	139
5.5.3	Security architecture for electric vehicle charging.....	144
5.6	CASE STUDIES.....	153
5.6.1	Interflex project (Dutch demonstrator)	153
5.6.2	Project Frequency Containment Reserves (FCR)	156
5.6.3	Wireless Charging in Rotterdam.....	159
CHAPTER 6.	GERMANY	164
6.1	BACKGROUND FOR POLICY MAKING ENVIRONMENT	164
6.2	EV CHARGING INFRASTRUCTURE POLICIES AND REGULATION.....	164
6.3	EV CHARGING INFRASTRUCTURE.....	169
6.4	EV DEMAND STATUS.....	170
6.5	EV INTEGRATION	171
6.5.1	Installation of Residential Chargers	172
6.5.2	Regulations for integration EV charging facilities	173
6.5.3	Charging management System	174
6.5.4	Metering of EV charging	176
6.5.5	Standards for EV integration.....	178
6.6	CASE STUDIES.....	187
6.6.1	Study on Distribution grid planning for a successful energy transition – focus on electromobility	187
6.6.2	3 connect.....	190
CHAPTER 7.	DENMARK	194
7.1	BACKGROUND FOR POLICY MAKING ENVIRONMENT	194
7.2	EV CHARGING INFRASTRUCTURE POLICIES AND REGULATIONS.....	194
7.3	EV CHARGING INFRASTRUCTURE.....	198
7.4	EV DEMAND STATUS.....	198
7.5	EV INTEGRATION	200
7.5.1	True Energy ApS	201
7.5.2	Barriers in the implementation of V2G technology in Demark	202
7.6	CASE STUDIES.....	207
7.6.1	The Parker project	207
7.6.2	Electric Vehicle Fleet Integration in the Danish EDISON Project – A Virtual Power Plant in the Island of Bornholm.....	212

CHAPTER 8. NORWAY.....	220
8.1 BACKGROUND OF EV POLICIES.....	220
8.2 EV CHARGING INFRASTRUCTURE POLICIES AND REGULATIONS.....	221
8.3 EV CHARGING INFRASTRUCTURE.....	222
8.4 EV DEMAND STATUS.....	224
8.5 EV INTEGRATION.....	227
8.5.1 Tariff Structure and Proposed Changes.....	228
8.6 CASE STUDIES.....	231
8.6.1 INVADE.....	231
8.6.2 Electrical Infrastructure for Good transport (ELinGO).....	232
CHAPTER 9. SWEDEN.....	236
9.1 BACKGROUND FOR POLICY MAKING ENVIRONMENT.....	236
9.2 EV CHARGING INFRASTRUCTURE POLICIES AND REGULATIONS.....	236
9.3 EV CHARGING INFRASTRUCTURE.....	237
9.4 EV DEMAND STATUS.....	239
9.5 EV INTEGRATION.....	240
9.6 CASE STUDIES.....	244
9.6.1 eRoadArlanda.....	244
9.6.2 Dynamic Wireless Power Transfer Charging Infrastructure for Future EVs: From Experimental Track to Real Circulated Roads Demonstrations.....	246
CHAPTER 10. THE REPUBLIC OF CHINA.....	251
10.1 BACKGROUND FOR POLICY MAKING ENVIRONMENT.....	251
10.2 EV CHARGING INFRASTRUCTURE POLICIES AND REGULATIONS.....	251
10.3 EV CHARGING INFRASTRUCTURE.....	255
10.4 EV DEMAND STATUS.....	260
10.5 EV INTEGRATION.....	260
10.6 CASE STUDIES.....	265
10.6.1 UK/China Project on Battery Characterization and Management.....	265
CHAPTER 11. COMPARATIVE ANALYSIS.....	266
11.1 EV CHARGING INFRASTRUCTURE.....	266
11.2 EV CHARGE POINT OPERATORS.....	274
11.3 POLICIES FOR EV CHARGING INFRASTRUCTURE.....	279
11.3.1 China.....	279

11.3.2	European Union	280
11.3.3	United States of America	281
11.4	GRID INTEGRATION OF EV CHARGING INFRASTRUCTURE	285
11.4.1	Installation of an EV charger.....	285
11.4.2	Impact of EV charging on the grid	285
11.4.3	Smart Charging, Ancillary Services and RE integration	288
11.4.4	Vehicle-to-grid (V2G) application.....	289
CHAPTER 12.	CONCLUSION AND WAY FORWARD	290
REFERENCES	293

List of Figures

FIGURE 1.1: A CHARGING POOL WITH MULTIPLE CHARGING STATIONS AND CHARGING POINTS	5
FIGURE 1.2: VARIOUS STAKEHOLDERS IN THE ELECTRIFICATION OF TRANSPORT	7
FIGURE 1.3: EV30@30 GLOBAL EV PROJECTIONS	7
FIGURE 1.4: GLOBAL STOCK OF EV CHARGERS FROM 2013 TO 2019	8
FIGURE 1.5: GLOBAL STOCK OF PRIVATE CHARGERS BY COUNTRY, 2019	9
FIGURE 1.6: GLOBAL STOCK PUBLIC MODERATE CHARGERS UP TO 22 kW BY COUNTRY, 2020	9
FIGURE 1.7: GLOBAL STOCK OF PUBLIC RAPID CHARGERS HIGHER THAN 22 kW	10
FIGURE 1.8: TOP 10 COUNTRIES BY CUMULATIVE PUBLIC CHARGING CONNECTOR INSTALLATIONS, 2020	11
FIGURE 1.9: POTENTIAL ISSUES CAUSED BY ADDITIONAL EV LOAD, EFFECTS AND SOLUTIONS	13
FIGURE 1.10: VOLTAGE VS ACTIVE POWER CURVE	13
FIGURE 1.11: STAGES OF EV MARKET DEVELOPMENT	21
FIGURE 2.1: HIDDEN ON-STREET CHARGING POINTS BY URBAN FORESIGHT	23
FIGURE 2.2: ROADMAP FOR ACHIEVING 100% ZEV BY 2035	24
FIGURE 2.3: GROWTH OF PUBLIC CHARGING POINT BY SPEED (2011 – 2020)	30
FIGURE 2.4: SHARE OF CONNECTOR TYPES AMONG RAPID PUBLIC CHARGERS TILL 2020	31
FIGURE 2.5: PIE CHART SHOWING SHARE OF PUBLIC CHARGERS AS PER CHARGING SPEED IN 2020	31
FIGURE 2.6: NUMBER OF EVs PER PUBLIC CHARGING POINT IN UK	32
FIGURE 2.7: BEV/PHEV MARKET STATISTICS IN UK	35
FIGURE 2.8: TOP 15 BEV/PHEV MODELS FROM OCTOBER 2019 TO SEPTEMBER 2020	36
FIGURE 2.9: INTERACTIVE MAP RELEASED BY WPD SHOWING THE CAPACITY AVAILABLE IN EACH DISTRIBUTION SUBSTATION FOR PLACEMENT OF EV CHARGERS	37
FIGURE 2.10: DURATION OF CHARGING AT PUBLIC RAPID CHARGE POINTS	38
FIGURE 2.11: PIE CHART SHOWING WHERE EV USERS CURRENTLY CHARGE THEIR VEHICLES	38
FIGURE 2.12: DISTRIBUTION NETWORK CONNECTION PROCEDURES.....	41
FIGURE 2.13: DEMAND RESPONSE ARCHITECTURE IN RESIDENCES	43
FIGURE 2.14: DEMAND RESPONSE ARCHITECTURE FOR CLOUD BASED CUSTOMER ENERGY MANAGER	44

FIGURE 2.15: ENCRYPTION AND COMMUNICATION OF INFORMATION BETWEEN THE DSRSP, CEM, ESA 45

FIGURE 2.16: OVERVIEW OF ESPIRIT TECHNOLOGY 51

FIGURE 2.17: CHINEHAM CLUSTER 51

FIGURE 2.18: UNCONSTRAINED AND ESPIRIT ENABLED NETWORK IMPACTS WITH INCREASING EV PENETRATION LEVELS, (X-AXIS: EV PENETRATION (IN %), Y-AXIS: THERMAL CAPACITY UTILIZED (IN %))..... 52

FIGURE 2.19: THE LV CONNECT AND MANAGE SOLUTION ARCHITECTURE 55

FIGURE 2.20: TYPICAL EXAMPLE OF THE EV CHARGE POINT AND DLC INSTALLATION IN CUSTOMERS' HOMES 56

FIGURE 2.21: OPERATION OF THE ANM SYSTEM FOR LIMITING THE IMPORT OF EVs (ONE-DAY VIEW) 59

FIGURE 2.22: OPERATION OF THE ANM SYSTEM FOR LIMITING THE IMPORT OF EVs (ONE-WEEK VIEW) 58

FIGURE 2.23: TRIAL PARTICIPANTS SPREAD.....63

FIGURE 2.24: EV CHARGING TARIFF 63

FIGURE 3.1: SHARE OF CONNECTOR TYPES AMONG CHARGERS IN PUBLIC CHARGING STATIONS IN USA 71

FIGURE 3.2: NUMBER OF CHARGING POINTS BASED ON CONNECTOR TYPE AND ACCESSIBILITY IN USA HERE PRIVATE CHARGERS IMPLY CAPTIVE PRIVATE CHARGERS.....72

FIGURE 3.3: BEV/PHEV MARKET STATISTICS IN USA 72

FIGURE 3.4: TOP 15 BEV/PHEV MODELS IN USA73

FIGURE 3.5: LIGHT DUTY ALTERNATIVE FUEL VEHICLES, HYBRID ELECTRIC VEHICLES OFFERED BY VEHICLE MANUFACTURERS 73

FIGURE 3.6: EPRI LOW, MEDIUM AND HIGH PEV MARKET PENETRATION SCENARIOS, SHOWING NEW ANNUAL EV SALES (LEFT) AND TOTAL FLEET SIZE (RIGHT). SOLID LINES CORRESPOND TO NUMBER OF VEHICLES (LEFT AXIS) AND DOTTED LINES CORRESPOND TO SALES SHARE (RIGHT AXIS) 74

FIGURE 3.7: HISTORICAL DATA SHOWING U.S. ANNUAL INCREMENTAL ENERGY GENERATION, AVERAGED IN 5-YEAR INCREMENTS. THE ENERGY REQUIREMENT FOR THE THREE SCENARIOS IS ALSO SHOWN. 75

FIGURE 3.8: HOSTING CAPACITY OF COMMERCIAL AND INDUSTRIAL FEEDER 75

FIGURE 3.9: THE RMS CURRENT OF A CHARGER DURING A CHARGING CYCLE 78

FIGURE 3.10: FOR 2 MINUTES INTO THE CHARGING CYCLE THE CURRENT WAVEFORM (TOP) AND ITS HARMONIC SPECTRUM (BOTTOM) 79

FIGURE 3.11: FOR 134 MINUTES INTO THE CHARGING CYCLE THE CURRENT WAVEFORM (TOP) AND ITS HARMONIC SPECTRUM (BOTTOM)79

FIGURE 3.12: FOR 2 MINUTES INTO THE CHARGING CYCLE THE CURRENT WAVEFORM (TOP) AND ITS HARMONIC SPECTRUM (BOTTOM)80

FIGURE 3.13:FOR 20 MINUTES INTO THE CHARGING CYCLE THE CURRENT WAVEFORM (TOP) AND ITS HARMONIC SPECTRUM (BOTTOM)81

FIGURE 3.14: TDD AT THE FEEDER WHEN ALL 5 CHARGERS ARE ACTIVE 82

FIGURE 3.15: ADDITIONAL REGULATION SERVICE REQUIREMENT WITH INCREASING WIND POWER IN ERCOT ASSUMING 5-MINUTE NODAL DISPATCH 83

FIGURE 3.16: ARCHITECTURE OF PILOT FOR PROVISION OF FRRS FROM EV FLEET IN FRITO-LAY FACILITY STANDBY84

FIGURE 3.17: SUCCESSFUL FRRS DEPLOYMENT STANDBY 85

FIGURE 3.18: AVERAGE PRICE FOR FREQUENCY REGULATION SERVICES PER 100 KWH IN 2013 STANDBY 86

FIGURE 3.19:SCHEMATIC OF THE LOS ANGELES AIR FORCE BASE VEHICLE TO GRID PROJECT88

FIGURE 3.20: CAISO AGC DISPATCH SETPOINT AND AGGREGATE EV METER SHOWN OVER A PERIOD OF 1 HOUR89

FIGURE 3.21: OVERALL SYSTEM ARCHITECTURE OF JUMPSMARTMAUI.....91

FIGURE 3.22: WEB PORTALS FOR PARTICIPANTS 91

FIGURE 3.23: EV COMMUNICATION NETWORK93

FIGURE 3.24: SMART CHARGING INFRASTRUCTURE WITH IEC 61850 STANDARD.....94

FIGURE 3.25: FLATTENING OF BASELOAD BY V2B SCHEDULING95

FIGURE 3.26: MITIGATION OF DUCK CURVE CAUSED DUE TO HIGH PV GENERATION IN BUILDING LOAD USING SMART CHARGING95

FIGURE 3.27: PG&E SYSTEM TRANSFORMER AS PER THEIR KVA RATINGS 98

FIGURE 3.28: TEMPERATURE MEASUREMENTS DURING POWER EXPORT 99

FIGURE 3.29: VARIATION OF CHARGING POWER WITH SOC..... 101

FIGURE 3.30: CHANGE IN SOC OF VEHICLE WHILE CHARGING 101

FIGURE 3.31: AVERAGE CHARGING POWER IN THE SOC WINDOW 102

FIGURE 3.32: VARIATION OF C-RATE WITH SOC FOR DC FAST CHARGING 102

FIGURE 3.33: COMPARISON OF VARIATION OF CHARGING POWER WITH SOC FOR FORD MUSTANG MACH-E AND VOLKSWAGEN ID.4 103

FIGURE 3.34: COMPARISON OF SOC FOR FORD MUSTANG MACH-E AND VOLKSWAGEN ID.4 104

FIGURE 4.1: SHARE OF CONNECTOR TYPES AMONG PUBLIC CHARGING STATIONS IN CALIFORNIA, USA109

FIGURE 4.2: NUMBER OF CHARGING POINTS BASED ON CONNECTOR TYPE AND ACCESSIBILITY IN CALIFORNIA, USA
 HERE PRIVATE CHARGERS IMPLY CAPTIVE PRIVATE CHARGERS 110

FIGURE 4.3: VEHICLE STOCK BASED ON FUEL TYPE IN CALIFORNIA TILL 2019 110

FIGURE 4.4: ANNUAL SALE OF EVS IN CALIFORNIA 111

FIGURE 4.5: GEOGRAPHIC DISTRIBUTION OF EVS IN THE STATE OF CALIFORNIA. LOS ANGELES HAS THE HIGHEST DENSITY OF
 EVs..... 111

FIGURE 4.6: BILLING PROCESS AND RESPONSIBILITIES OF THE SUBMETERING STAKEHOLDERS116

FIGURE 4.7: DATA FLOW FROM EVSE TO UTILITY..... 117

FIGURE 4.8: TIME SHIFT IN DATA BETWEEN UTILITY METER AND SUBMETER 118

FIGURE 4.9: EXISTING DCFC LOCATIONS IN CALIFORNIA120

FIGURE 4.10: METHODOLOGY FOR DETERMINATION OF DCFC LOCATION WITHIN THE ONE-MILE BUBBLE 120

FIGURE 4.11: V2H IN ISLANDED OPERATION 123

FIGURE 4.12: COLD LOAD PICKUP DEMONSTRATION 124

FIGURE 4.13: ISLANDED HOME WITH EV IN PARALLEL WITH PV..... 125

FIGURE 4.14: ARCHITECTURE OF INVENT PROJECT 128

FIGURE 5.1:E-MOBILITY IN THE NETHERLANDS 129

FIGURE 5.2: TRENDS IN EV CHARGING INFRASTRUCTURE DEPLOYMENT IN THE NETHERLANDS 134

FIGURE 5.3: EV CHARGING POINTS IN THE NETHERLANDS 135

FIGURE 5.4: ANNUAL REGISTERED PASSENGER EVS BY ENGINE TYPE 136

FIGURE 5.5: EVs MARKET SHARE 136

FIGURE 5.6: REGISTERED EVs BY CHASSIS TYPE IN THE NETHERLANDS..... 137

FIGURE 5.7: BEHAVIOURAL ANALYSIS OF THE EV CHARGING SESSIONS BASED ON THEIR LOCATION OF CHARGING
 143

FIGURE 5.8: A) LOAD AND RE GENERATION PATTERNS, B) AMOUNT OF ENERGY THAT IS SHIFTED FOR LOAD FLATTENING
 SCENARIO, C) AMOUNT OF ENERGY THAT IS SHIFTED FOR LOAD BALANCING SCENARIO 144

FIGURE 5.9: SHARE OF CHARGING SESSIONS PER MONTH 149

FIGURE 5.10: INITIAL SoC FOR EACH LOCATION 150

FIGURE 5.11: IMPACT OF SMART CHARGING ON ENERGY USED PER HOUR 150

FIGURE 5.12: OVERVIEW OF DIMENSIONS INVESTIGATED IN THE STUDY 151

FIGURE 5.13: DIFFERENCE IN GENERATION BETWEEN RTP- AND BASE SCENARIO FOR EU COUNTRIES 152

FIGURE 5.14: ARCHITECTURE OF THE PROJECT 155

FIGURE 5.15: PRE-QUALIFICATION PROCESS IN PROJECT FCR, SOURCE: 157

FIGURE 5.16: FCR PROJECT OPERATION, SOURCE 158

FIGURE 5.17: COMPONENT OF WIRELESS CHARGING 161

FIGURE 6.1: POWER OUTPUT OF EV CHARGING POINTS IN GERMANY 169

FIGURE 6.2: TREND OF PUBLICLY ACCESSIBLE CHARGERS TILL 2021 170

FIGURE 6.3: REGISTERED PASSENGER EVs BY ENGINE TYPE 170

FIGURE 6.4: TOP 10 REGISTERED EVs IN GERMANY 171

FIGURE 6.5: PROJECTED ELECTRICITY GENERATION MIX FOR 2050, 172

FIGURE 6.6: ACTIVE CHARGE MANAGEMENT 175

FIGURE 6.7: DYNAMIC CHARGE MANAGEMENT 175

FIGURE 6.8: SCHEDULED CHARGE MANAGEMENT 176

FIGURE 6.9: DIFFERENT METERING ARRANGEMENTS TO METER EV CHARGING LOADS, SINGLE MEASURED CHARGING POINT (TOP LEFT), SINGLE MEASURED CONTROLLABLE CHARGING POINT (TOP RIGHT), SEVERAL INDIVIDUALLY MEASURED CHARGING POINTS (BOTTOM LEFT) AND SEVERAL CHARGING POINTS BUT ONE MEASUREMENT UNIT (BOTTOM RIGHT) 177

FIGURE 6.10: ELECTRICITY CONSUMPTION OF BEVs ON A TYPICAL WEEKDAY 180

FIGURE 6.11: REDUCTION OF CUMULATIVE DISTRIBUTION NETWORK INVESTMENT THROUGH SMART CHARGING, 189

FIGURE 6.12: VPP CONCEPT IN OPTIMAX POWERFIT 192

FIGURE 7.1: CURRENT ATTAINED PERCENTAGE OF THE NPF TARGETS 194

FIGURE 7.2: NUMBER OF PUBLICLY ACCESSIBLE CHARGERS IN DENMARK 198

FIGURE 7.3: NUMBER OF ELECTRIC CARS, NEW SALES AND MARKET SHARE IN NORDIC COUNTRIES, 2010-17 199

FIGURE 7.4: COMPARISON OF MONTHLY EV SALES FOR 2019 AND 2020 IN DENMARK 200

FIGURE 7.5: EV SALES IN 2020 BY MODEL TYPE, (BLUE IS BEV AND BEIGE IS PHEV) 200

FIGURE 7.6: USE OF EV FOR PROVISION OF FCR-N SERVICES AS PERFORMED BY TRUE ENERGY 201

FIGURE 7.7: HOURLY GENERATION OF RE SOURCES IN THE ISLAND AND FLOW IN THE INTERCONNECTION WITH SWEDEN 204

FIGURE 7.8: SOC EVOLUTION WHEN DELIVERING FCR-N WITH +/- 6.9kW PF REGULATING POWER. EVERY LINE DENOTES A DIFFERENT SESSION 206

FIGURE 7.9: PROJECT ARCHITECTURE FOR FNR SERVICES 208

FIGURE 7.10: DROOP CONTROL FOR FNR SERVICE 208

FIGURE 7.11: FNR SERVICE PROVIDED BY AN EV 209

FIGURE 7.12: TIME DIFFERENCE BETWEEN POWER REQUESTED AND POWER PROVIDED FOR ONE EV 209

FIGURE 7.13: THE VPP CONCEPT 213

FIGURE 7.14: CENTRALIZED VS DISTRIBUTED VPP 213

FIGURE 7.15: FUNCTION BASED DESIGN FOR VPP 214

FIGURE 7.16: ENVIRONMENT DIAGRAM OF INTEGRATED EVPP 215

FIGURE 7.17: MODULE DIAGRAM OF EVPP 215

FIGURE 7.18: BORNHOLM 60 kV DISTRIBUTION GRID 218

FIGURE 7.19: GENERATION AND LOAD VISUALIZATION..... 219

FIGURE 8.1: SHARE OF CONNECTOR TYPES AMONG PUBLIC CHARGING STATIONS IN NORWAY 224

FIGURE 8.2: NUMBER OF EVs PER PUBLIC CHARGING STATION IN NORWAY 224

FIGURE 8.3: NUMBER AND MARKET SHARE OF BEV AND PHEV IN NORWAY 225

FIGURE 8.4: VEHICLE STOCK CATEGORIZED BY CHASSIS AND FUEL TYPE 226

FIGURE 8.5: STOCK OF PERSONAL 4 WHEELER VEHICLES BY TYPE OF FUEL TILL 2020, SHOWN IN PERCENTAGE OF TOTAL VEHICLE STOCK 226

FIGURE 8.6: BEV/PHEV SALES IN 2020 BASED ON VEHICLE MAKE AND MODEL 227

FIGURE 8.7: PEAK ELECTRICITY DEMAND OF DETACHED NORWEGIAN HOUSES WITH HOME CHARGING 228

FIGURE 8.8: CHANGES IN ELECTRICITY CONSUMPTION FOR DIFFERENT SCENARIOS 229

FIGURE 8.9: CURRENT AND PROPOSED CHANGES IN STRUCTURE OF ELECTRICITY BILL 230

FIGURE 8.10: THREE MAIM MODELS OF TARIFF STRUCTURE 231

FIGURE 8.11: INTERACTION DIAGRAM OF THE NORWEGIAN PILOT 232

FIGURE 8.12: OVERHEAD LINES IN USE FOR ROAD ELECTRIFICATION..... 233

FIGURE 8.13: ELECTRIFIED RAILS..... 233

FIGURE 8.14: ON ROAD INDUCTIVE CHARGING..... 234

FIGURE 8.15: ROUTE E39 FROM TRONDHEIM TO KRISTIANSAND 234

FIGURE 8.16: ANNUAL CO₂ EMISSIONS WITH DIESEL AND ELECTRIC ROADS 235

FIGURE 8.17: CUMULATIVE CO₂ EMISSION 235

FIGURE 9.1: DETAILS OF PUBLIC CHARGING STATIONS IN SWEDEN 238

FIGURE 9.2: NUMBER OF EVs PER PUBLIC CHARGING POINT IN SWEDEN 238

FIGURE 9.3: PASSENGER VEHICLES BY FUEL TYPE 239

FIGURE 9.4: BEV SALES UP TO 2021 240

FIGURE 9.5: PHEV SALES UP TO 2021 240

FIGURE 9.6: LOAD AND VOLTAGE VARIATIONS 242

FIGURE 9.7: RESULT OF DIFFERENT SCENARIOS FOR THE RURAL GRID 242

FIGURE 9.8: DIFFERENCE BETWEEN URBAN AND RURAL RESULTS FOR ALL THE SCENARIOS 243

FIGURE 9.9: INSTALLATION OF COILS FOR WIRELESS ENERGY TRANSFER IN THE SMARTROAD GOTLAND PILOT 244

FIGURE 9.10: A SCHEMATIC OF EV CHARGING IN EROADARLANDA PROJECT 246

FIGURE 9.11: PROPOSED REQUIREMENT OF ELECTRIFIED ROADS IN A ROAD NETWORK 246

FIGURE 9.12: FUNCTIONAL SCHEMATIC OF EV CHARGING INFRASTRUCTURE 248

FIGURE 9.13: WPT COMPONENTS (BLUE), ADDITIONAL COMPONENTS (GREEN), ORIGINAL (YELLOW) 249

FIGURE 9.14: DYNAMIC BIDIRECTIONAL WPT IN A FUTURE ROAD INFRASTRUCTURE ECOSYSTEM 250

FIGURE 10.1: GROWTH OF PUBLIC CHARGING POINTS IN CHINA 256

FIGURE 10.2: ANNUAL INSTALLATION OF PUBLIC CHARGERS IN CHINA 256

FIGURE 10.3: MONTHLY INSTALLATION OF CHARGERS IN 2020 IN CHINA 257

FIGURE 10.4: SHARE OF CHARGING POINTS IN CHINA BY OPERATOR 257

FIGURE 10.5: SHARE OF CHARGING POINTS IN CHINA BY CHARGER TYPE AND OPERATOR 258

FIGURE 10.6: NUMBER OF PUBLIC AND DEDICATED FLEET CHARGERS PER CITY/PROVINCE 258

FIGURE 10.7: CHINA STATE GRID HIGHWAY CHARGING CORRIDOR 259

FIGURE 10.8: CHINA EV STOCK BY ENGINE TYPE 260

FIGURE 10.9: CONTRIBUTION OF EVS TO HOURLY PEAK DEMAND BY COUNTRY/REGION IN THE EVENING 261

FIGURE 10.10: PROBABILITY OF CHARGING FOR DIFFERENT VEHICLE TYPES WITH DIFFERENT CHARGING OPTIONS 262

FIGURE 10.11: MODELLING FRAMEWORK OF THE ENERGY SYSTEM OPTIMIZATION 263

FIGURE 10.12: THE LOAD PROFILE DUE TO DIFFERENT EV CHARGING SCENARIOS AND ALSO THE ASSOCIATED WIND CURTAILMENT..... 264

FIGURE 11.1: PUBLIC CHARGE POINTS BASED ON POWER RATING AMONG DIFFERENT COUNTRIES 267

FIGURE 11.2: CHARGE POINTS PER EV IN THE DIFFERENT COUNTRIES 267

FIGURE 11.3: PUBLIC CHARGING INFRASTRUCTURE IN DIFFERENT COUNTRIES 268

FIGURE 11.4: CHARGER POWER RATINGS IN PUBLIC CHARGING STATION FOR EACH COUNTRY 268

FIGURE 11.5: NUMBER OF EVS IN THE DIFFERENT COUNTRIES 269

FIGURE 11.6: NUMBER OF PUBLIC SLOW CHARGING POINTS PER EV (HIGHER IS BETTER) 269

FIGURE 11.7: NUMBER OF PUBLIC FAST CHARGING POINTS PER EV (HIGHER IS BETTER) 269

FIGURE 11.8: NUMBER OF PUBLIC RAPID CHARGE POINTS PER EV (HIGHER IS BETTER)270

FIGURE 11.9: COMPARISON OF NUMBER OF CHARGE POINTS PER VEHICLE AMONG THE 5 COUNTRIES270

FIGURE 11.10: NUMBER OF PRIVATE EV PER PUBLIC SLOW CHARGER271

FIGURE 11.11: NUMBER OF PRIVATE EV PER PUBLIC FAST CHARGER271

FIGURE 11.12: NUMBER OF PRIVATE EV PER PUBLIC RAPID CHARGER272

FIGURE 11.13:: NUMBER OF PRIVATE EV PER PUBLIC CHARGER272

FIGURE 11.14: RADAR MAP SHOWING THE NUMBER OF CHARGERS PER VEHICLE FOR THE DIFFERENT CHARGER TYPES I.E.,
THE PREFERENCE OF CHARGER TYPES FOR EACH COUNTRY273

FIGURE 11.15: ANNUAL PUBLIC CONNECTOR INSTALLATIONS ACROSS EUROPE273

FIGURE 11.16: PUBLIC CHARGING POINTS IN EUROPE AS PER CHARGING POWER AND CONNECTOR TYPE274

FIGURE 11.17: NUMBER OF OPERATORS WITH OVER 3,000 PUBLIC CHARGING CONNECTORS BY REGION275

FIGURE 11.18: NUMBER OF OPERATORS WITH OVER 1,000 PUBLIC FAST OR ULTRA-FAST CHARGING CONNECTORS BY REGION
.....275

FIGURE 11.19: MARKET SHARE OF PUBLIC CHARGING OPERATORS IN USA ACROSS ALL CHARGER TYPES276

FIGURE 11.20: MARKET SHARE OF PUBLIC CHARGING OPERATORS IN USA ACROSS FAST AND ULTRA-FAST CHARGER TYPES
.....276

FIGURE 11.21: MARKET SHARE OF PUBLIC CHARGING OPERATORS IN EUROPE ACROSS ALL CHARGER TYPES276

FIGURE 11.22: MARKET SHARE OF PUBLIC CHARGING OPERATORS IN EUROPE ACROSS FAST AND ULTRA-FAST CHARGER
TYPES276

FIGURE 11.23: MARKET SHARE OF PUBLIC CHARGING OPERATORS IN CHINA ACROSS ALL CHARGER TYPES277

FIGURE 11.24: MARKET SHARE OF PUBLIC CHARGING OPERATORS IN CHINA ACROSS FAST AND ULTRA-FAST CHARGER TYPES
.....277

FIGURE 11.25: AVERAGE ENERGY DELIVERED PER DAY PER CHARGER BY DIFFERENT CHARGE POINT OPERATORS IN USA AND
EUROPE ALONG WITH THEIR UTILIZATION278

FIGURE 11.26: AVERAGE ENERGY DELIVERED PER DAY PER CHARGER BY DIFFERENT CHARGE POINT OPERATORS IN CHINA
ALONG WITH THEIR UTILIZATION278

FIGURE 11.27: GROWTH OF ELECTRICITY DEMAND AND NUMBER OF PUBLIC CHARGERS BY 2030 COMPARED TO 2020
.....279

FIGURE 11.28: ANNUAL ELECTRICITY DEMAND FOR EV CHARGING ACROSS VEHICLE SEGMENTS286

FIGURE 11.29: TOTAL ANNUAL ELECTRICITY DEMAND FOR EV CHARGING286

FIGURE 12.1: SUMMARY OF ELECTRIFICATION TARGETS, ICE BANS AND NET-ZERO EMISSIONS PLEDGES 290

List of Tables

TABLE 1.1: ANALYTICAL FRAMEWORK FOR EV CHARGING INFRASTRUCTURE POLICY.....	15
TABLE 2.1: DISTRIBUTION OF UK POPULATION AND EVS AMONG DIFFERENT RESIDENCE TYPES	32
TABLE 2.2: FORECAST FOR THE UPTAKE OF EV IN UK ASSUMING AN AVERAGE CAR LIFE-SPAN OF 15 YEARS AND STABLE REGISTRATION OF 2.2M CARS PER YEAR	35
TABLE 2.3: TYPICAL COST FOR A NEW CONNECTION.....	39
TABLE 2.4: RATINGS OF POWER GENERATION MODULES	41
TABLE 2.5: PRIORITY OF OPERATING MODES	46
TABLE 2.6: INFORMATION PASSED FROM ESA TO CEM DURING AUTHENTICATION.....	47
TABLE 2.7: INFORMATION PASSED FROM THE CEM TO THE ESA DURING AUTHENTICATION	47
TABLE 2.8: INFORMATION PASSED FROM CEM TO DSRSP DURING AUTHENTICATION	47
TABLE 2.9: INFORMATION PASSED FROM DSRSP TO CEM DURING AUTHENTICATION	48
TABLE 2.10: INFORMATION SENT FROM THE ESA TO THE DSRSP VIA THE CEM	48
TABLE 2.11: INFORMATION SENT FROM DSRSP TO ESA VIA CEM	48
TABLE 2.12: INFORMATION PASSED FROM ESA TO THE DSRSP VIA THE CEM DURING NORMAL OPERATION	49
TABLE 2.13: INFORMATION PASSED FROM THE DSRSP TO THE ESA DURING NORMAL OPERATION	49
TABLE 3.1: EV CHARGING INFRASTRUCTURE POLICY IN THE USA	68
TABLE 3.2: THD FOR LEVEL 2 CHARGER AT DIFFERENT POINTS OF THE CHARGING CYCLE	79
TABLE 3.3: THD AT DIFFERENT PHASES IN DIFFERENT TIMES OF THE CHARGING CYCLE	81
TABLE 3.4: POTENTIAL REVENUE FOR PARTICIPATING IN THE 5:00PM-9:00 PM TIMEFRAME.....	86
TABLE 3.5: USE CASE OF VOGSS EQUIPPED PHEV.....	98
TABLE 4.1: EV CHARGING INFRASTRUCTURE POLICIES FOR THE STATE OF CALIFORNIA, USA	105
.....	105
TABLE 4.2: EV TARIFF STRUCTURE BY SDG&E	112
TABLE 4.3: EV CHARGING TARIFF AS PER PG&E.....	114
TABLE 4.4: TARIFF STRUCTURE OFFERED BY SCE	115
TABLE 4.5: CHARGERS PASSING THE ACCURACY TEST OF MAXIMUM 2% ERROR IN MEASUREMENTS BY UTILITY.....	117
TABLE 4.6: COMPARISON OF V2H, V2G AND V2H+V2G SYSTEMS.....	122
TABLE 4.7: KEY STANDARDS FOR V2G AND V2H	122
TABLE 4.8: SUMMARY OF RESULTS.....	125
TABLE 5.1: EV CHARGING INFRASTRUCTURE POLICY IN THE NETHERLANDS	131
TABLE 5.2: SECURITY AND ACCESS TO THE CPO CENTRAL SYSTEM	145
TABLE 5.3: ACCESS RIGHTS TO CHARGING STATION AND INTERFACE FOR COMMUNICATION	146

TABLE 5.4: CONSORTIUM ENTITIES AND THEIR ROLE	160
TABLE 5.5: POWER CLASSES AND POWER RATING	162
TABLE 5.6: AIR-GAP CLEARANCE CLASSES	162
TABLE 5.7: WIRELESS CHARGING SYSTEM LOSS COMPONENTS	162
TABLE 6.1: TYPICAL EV CHARGER INSTALLATION COST IN AREA SERVED BY STROMNETZ BERLIN	173
TABLE 6.2: METERS BASED ON CONSUMPTION LEVELS AND REPLACEMENT TIMELINE	177
TABLE 6.3: GENERAL REQUIREMENTS	178
TABLE 6.4: STANDARDS FOR CHARGING INTERFACE	178
TABLE 7.1: EV CHARGING INFRASTRUCTURE POLICY IN DENMARK.....	196
TABLE 7.2: ECONOMIC BARRIERS FOR V2G IMPLEMENTATION	202
TABLE 7.3: TECHNOLOGICAL BARRIERS FOR V2G	203
TABLE 7.4: SOCIAL BARRIERS	204
TABLE 7.5: COST COMPARISON OF ANNUAL CHARGING COST FOR DIFFERENT CHARGING STRATEGIES.....	205
TABLE 7.6: CONTROLLABILITY ATTRIBUTES	210
TABLE 7.7: OBSERVABILITY ATTRIBUTES	210
TABLE 7.8: PERFORMANCE INDICATORS	211
TABLE 8.1: HISTORICAL DEVELOPMENT OF EV POLICIES IN NORWAY	220
TABLE 8.2: EV CHARGING INFRASTRUCTURE POLICY IN NORWAY	221
TABLE 8.3: TECHNICAL DETAILS OF EVSE IN NORWAY.....	222
TABLE 9.1: SCENARIO SUMMARY.....	241
TABLE 10.1: EV CHARGING IN CHINA	255
TABLE 10.2: SCENARIOS CONSIDERED	263
TABLE 10.3: REDUCTION IN CO2 AND NOX EMISSION UNDER DIFFERENT COMBINATIONS OF WIND PENETRATION AND EV CHARGING STRATEGIES	264
TABLE 11.1: BUILDING BYE-LAW IN DIFFERENT STATES OF UNITED STATES	283
TABLE 11.2: V2G PILOT PROJECTS THROUGHOUT THE WORLD	289

Abbreviations

μ-DMS	micro Distribution Management System	DAQ	Data Acquisition
2 W	2 wheeler	DC	Direct Current
3 W	3 wheeler	DCFC	DC Fast Charger
4 W	4 wheeler	DER	Distributed Energy Resources
AC	Alternating Current	DER-CAM	Distributed Energy Resources Customer Adoption Model
AEV	Automated and Electric Vehicles	DLC	Domestic Load Control
AGC	Automatic Generation Control	DMS	Distribution Management System
ANM	Active Network Management	DNO	Distribution Network Operator
API	Application Programming Interface	DNP	Distributed Network Protocol
ARIG	Aggregated Remote Intelligent Gateway	DOET	Dutch Organisation for Electric Transport
B2B	Business to Business	DSO	Distribution System Operator
BESS	Battery Energy Storage System	DSO	Distribution System Operator
BEV	Battery Electric Vehicle	DSO	Distribution System Operator
BMS	Battery Management System	DSR	Demand Side Response
BPL	Broadband-over-Powerline	DSRC	Direct Short-Range Communication
BRP	Balancing Responsible Party	DSRSP	Demand Side Response Service Provider
BSI	British Standards Institution	EEX	European Electricity Exchange
C rate	Charging rate	ELECTRIC	Electric Clean Transport Road Infrastructure Corridor
CA	Commercial Aggregator	EMC	Electro Magnetic Compatibility
CAISO	California Independent System Operator	EMF	Electromagnetic Field
CCC	Committee on Climate Change	EMI	Electromagnetic Interference
CCGT	Combined Cycle and Gas Turbine	EPIC	Electric Program Investment Charge
CCS	Combined Charging System	EPSRC	Engineering and Physical Sciences Research Council
CEA	Central Electricity Agency	ERCOT	Electric Reliability Council of Texas
CEM	Customer Energy Manager	EREC	Engineering Recommendation
CERC	Central Electricity Regulatory Commission	ESA	Energy Smart Appliance
CG	Communication Gateway	EV	Electric Vehicle
CH	Control Horizon	EVCS	Electric Vehicle Charging Station
CHAdemo	Charge de Move	EVHS	Electric Vehicle Home Charge Scheme
CPO	Charge Point operator		
CSP	Curtailment Service Providers		
CVRP	Clean Vehicle Rebate Project		

EVPP	Electric Vehicle Virtual Power Plant	NSFC	Natural Science Foundation of China
EVSE	Electric Vehicle Supply Equipment	OB-EVI	On-Base Electric Vehicle Infrastructure
FAP	Flexibility Aggregator Platform	OCPI	Open Charge Point Interface
FCEV	Fuel Cell Electric Vehicles	OCPP	Open Charge Point Protocol
FCR	Frequency Containment Reserves	OCPP	Open Charge Point Protocol
FFT	Fast Fourier Transform	OSCP	Open Smart Charging Protocol
FNR	Frequency-controlled normal operation reserve	OH	Optimization Horizon
FO	Flexibility Operator	ORCS	On-street Residential Charge point Scheme
FRRS	Fast Response Regulation Service	OZEV	Office for Zero Emission Vehicles
G2V	Grid to Vehicle	PAS	Publicly Available Specification
GDPR	General Data Protection Regulation	PFC	Power Factor Correction
GHG	Green House Gas	PHEV	Plug-in Hybrid Electric Vehicle
GSM	Global System for Mobile Communications	PJM	Pennsylvania, New Jersey, and Maryland interconnection
HEV	Hybrid Electric Vehicle	PKI	Public Key Infrastructure
HMI	Human Machine Interface	PLC	Power Line Communication
HVAC	High Voltage AC	PLC	Powerline Communication
ICB	Intelligent Control Box	PLDV	Passenger Light-Duty Vehicles
ICE	Internal Combustion Engine	PoC	Point of Coupling
INR	Indian Rupees	POSOCO	Power system Operation Corporation
IOU	Investor-Owned Utilities	QSE	Qualified Scheduling Agency
IP	Internet Protocol	RCD	Residual Current Device
IPT	Inductive wireless power transfer	RE	Renewable Energy
ISO	International Organisation for Standards	SCADA	Supervisory Control and Data Acquisition System
ISO	Independent System Operator	SCC	Super Control Centre
LA	Local Aggregator	SCE	Southern California Edison
LCT	Low Carbon Technologies	SERC	State Electricity Regulatory Commission
LDV	Light Duty Vehicle	SGCC	State Grid Corporation of China
LIMS	Local Infrastructure Management Service	SLDC	State Load Dispatch Centre
LV	Low Voltage	SoC	State of Charge
MC	Monitor Controller	SVC	Static VAR Compensators
MCB	Mini Circuit Breakers	TCO	Total Cost of Ownership
MMS	Manufacturing Message Specification	TDD	Total Demand Distortion
MV	Medium Voltage	TfL	Transport for London
		THD	Total Harmonic Distortion

TNO	Transmission Network Operator
ToU	Time of Use
UCLA	University of California, Los Angeles
UNC	uncontrolled charging
V2B	Vehicle to Building
V2G	Vehicle to Grid
V2X	Vehicle-to-everything
VAT	Value Added Tax
VOGSS	Vehicle On-site Grid Support System
VPN	Virtual Private Network
VPP	Virtual Power Plant
VSF	Voltage Sensitivity Factor
WCS	Workplace Charging Scheme
WD	Weekdays
WE	Weekend days
WPD	Western Power Distribution's
WPT	Wireless Power Transfer
ZEV	Zero Emission Vehicles

Chapter 1. Introduction

1.1 Background

The global Electric Vehicle (EV) fleet is poised to increase exponentially in what has been dubbed as the electric mobility revolution. The push for EVs is driven by the global climate agenda established under the Paris Agreement to reduce carbon emissions to limit global warming. Importantly, not only would a switch from combustion-engine vehicles to EVs lead to lower emissions, but it would also result in reduction of air pollution. In addition, the deployment of EVs is also driven by national agendas to reduce oil demand and as such dependence on oil imports, as well as the encouragement of a local EV manufacturing industry for job creation. On the other hand, through several grid support services, EVs are expected to strengthen the grid and help accommodate higher renewable energy penetration while maintaining secure and stable grid operation.

The global electric mobility revolution is today defined by the rapid growth in electric vehicle (EV) uptake. It is estimated that two in every hundred cars sold today are powered by electricity. This phenomenon is today defined by the rapid growth in EV uptake, with EV sales for the year 2019, reaching 2.1 million. The global EV fleet totalled 7.2 million in 2019 with EVs accounting for 1 % of the global vehicle stock and 2.6 % of global car sales.

In India, EVs currently represent a small share with approximately 750,000 vehicles. The country has set a target of 30% electric vehicle sales across all vehicle types by 2030. India has over 250 million vehicles, and this fleet is dominated by 2-wheelers, accounting for 78% of the total vehicles (Bhagwat et al., 2019). Amongst the different vehicle segments, public buses, taxi fleets, 2-wheelers and three-wheelers are expected to be the first adopters of EVs. As the country is at an early stage of EV deployment, public charging infrastructure is still limited. In this context, the Ministry of Power has already identified 9 major cities and 11 intercity routes as pilots to enable EV charging infrastructure. Similarly, a number of states have also started introducing policies to promote EV adoption and charging infrastructure deployment, with Meghalaya being the latest state to introduce the draft EV policy (February 2021). Currently (as of February 2021) 15 states and Union territories of India have final or draft EV policies in place.

The rapid growth in EV uptake required to reach India's policy targets will have to address two major challenges. The first challenge is ensuring the deployment of the charging infrastructure required to serve the needs of the ever-growing number of EVs. The second challenge is the secure and efficient integration of EVs into the power system. The success of the EV revolution

hinges primarily on the timely deployment of effective EV charging infrastructure. However, at the same time, EV adoption is the main driver for the business case of EV charging infrastructure. Policy and regulation, informed by a thorough understanding of the EV charging ecosystem, can offer solutions to this chicken-and-egg problem.

Although the e-mobility plan is developed at the central level, the onus is on the state governments, which have to develop and implement policies and regulatory frameworks to enable the adoption of EVs and deployment of charging infrastructure in their respective states. Thus, considering India's federal structure as well as the wide variance in the social-geographic and economic variances between states, a one-size fits all approach cannot be applied (an example being the use of informal form of transportation in varying social geographies). The development of adequate charging and power system infrastructure to support the up-take of EVs would rest upon state-specific policy, regulatory measures, and effective implementation of such policy and regulatory interventions.

1.2 About this Study

The Nationally Determined Contribution – Transport Initiative for Asia (NDC-TIA) is a regional initiative funded by the International Climate Initiative (IKI) of German Federal Ministry for the Environment, Nature Conservation and Nuclear Safety (BMU). It is a joint project of seven organizations and with the engagement of China, India, and Vietnam. The organizations partnering with GIZ on this project are World Resources Institute (WRI), International Council on Clean Transportation (ICCT), International Transport Forum (ITF), Agora Verkehrswende, REN21 and SLOCAT. For the India component of the NDC-TIA project, the implementing partner is the National Institution for Transforming India (NITI Aayog).

Under the NDC-TIA India Component, we have an ongoing project “Integration of Electric Vehicles charging infrastructure with distribution grid: Global review, India's gap analyses and way forward” which is focused on conducting Indian and International review on overall environment related to EV charging. This project is carried out by consortium led by IIT Bombay along with Florence School of Regulation (FSR), Technical University Denmark (DTU), Cardiff University and Universidad Pontificia Comillas.

This specific study focuses on EV charging infrastructure, related policy and regulatory measures, grid integration of EVs, and the way forward for smooth EV adaption in the Indian EV ecosystem. The study developed a framework along with the inputs from a detailed critical international review on EV charging infrastructure development and its grid integration from different EV rich countries. The developed framework has been used as a basis for *identifying gaps and scope for*

improvement in EV charging infrastructure adoption at the national level and in the States. The study based on a combination of desk *research, surveys, bilateral consultations with stakeholders, and* consultation workshops has been used to identify and *recommend National and state specific interventions* that can be sandboxed for the use by regulators, policy makers, DISCOMS, and other stakeholders, and later adopted statewide.

1.2.1 Aim of the Study

The aim of this study is to conduct a high-quality study with high impact/quality reports that can be used by the Government of India including State Governments, distribution system operators, transmission system operators, planning and regulatory agencies and other stakeholders (EV industry etc.) to frame, adapt, and/or revise policies, regulations, technical charging standards, communication protocols related to the integration of EV charging infrastructure with distribution and the transmission grid.

1.2.2 Objectives of the Study

A detailed study was conducted based on critical international review on EV charging infrastructure and its grid integration from different EV rich international countries (besides India) with the main thrust on the following points:

- Planning and operation of the distribution grid with integration of EV charging infrastructure
- Grid support services from electric vehicles to facilitate large-scale renewable energy integration
- Technologies and standards for EV charging infrastructure's integration with distribution grid
- Policies and regulations for EV charging infrastructure and integration with distribution grid
- Identifying the key challenges and recommendations for efficient, effective and sustainable integration of EV charging infrastructure in India

1.2.3 Organization of the Study Reports

The outcome of this study is documented in a series of four technical reports. The four reports listed below cover different aspects of EV integration in a structured manner for effective, organized, and easy dissemination of the study outcome.

- **Report-1: Fundamentals of Electric Vehicle Charging Technology and its Grid Integration.**
- **Report-2: International review of Electric Vehicle Charging Infrastructure and its Grid Integration**
- **Report-3: Status Quo of Electric Vehicle Charging Infrastructure and Grid Integration in India**
- **Report-4: Gap analysis and Recommendations for EV integration in India**

Report-2: International Review of Electric Vehicle Charging Infrastructure and its Grid Integration

This specific report is the second in the series of four reports and it documents analysis of international experience on EV charging infrastructure developments, grid integration of EVs, policy and regulatory review, and various cases studies, demonstrations and commercial implementation of EV charging technology and grid integration. The countries covered in depth in this report are: United Kingdom, United States of America, Germany, The Republic of China, Norway, Denmark, The Netherlands and Sweden. The aim of this report is to provide an overview of EV charging evolution from EV rich countries which would help the Indian stakeholders, both Government and private, to develop measures which could be implemented in India. This report would act as a one of the reference documents to facilitate framing customized recommendations for integrating EVs with the Indian grid.

1.3 Key Terminologies

- **Electric Vehicle (EV):** Any vehicle which has an electric motor and can be powered by battery storage, fuel cell, photovoltaic array, or any other source of electric current. An EV can either be a hybrid electric vehicle or a battery electric vehicle.
- **Battery Electric Vehicle (BEV):** A battery electric vehicle is only powered by a battery storage and cannot be powered by any other type of fuel.
- **Hybrid Electric Vehicle (HEV):** An HEV combines an internal combustion engine powered by conventional fuels with a battery-powered electric motor. The battery is charged using the IC engine and through regenerative braking.
- **Plug-in Hybrid Electric Vehicle (PHEV):** PHEVs are hybrid EVs, but the batteries in PHEV can be charged by plugging into an electrical outlet.

- **Charging Point/ Electric Vehicle Supply Equipment (EVSE):** A charging point or an EVSE is the actual point of connection of the EV with the electrical network. A charging point or EVSE can have different connectors attached to it for compatibility purposes but only one may be used at a time. (SWEET, n.d.)
- **Charging Station/ Electric vehicle Charging Station (EVCS):** A charging station or EVCS is the physical station with one or more charging points.
- **Charging Pool:** A charging pool consists of multiple charging stations within a geographical area as shown in Figure 1.1. The charging pool is operated by one charge point operator.
- **Connector:** A connector is a physical interface between the EVSE and the EV. Based on different standards there are different connectors such as J1772, Mennekes Type 2 connector etc.
- **Charge Point Operator (CPO):** The charge point operator is responsible for the management, maintenance, and operation of the charging stations.

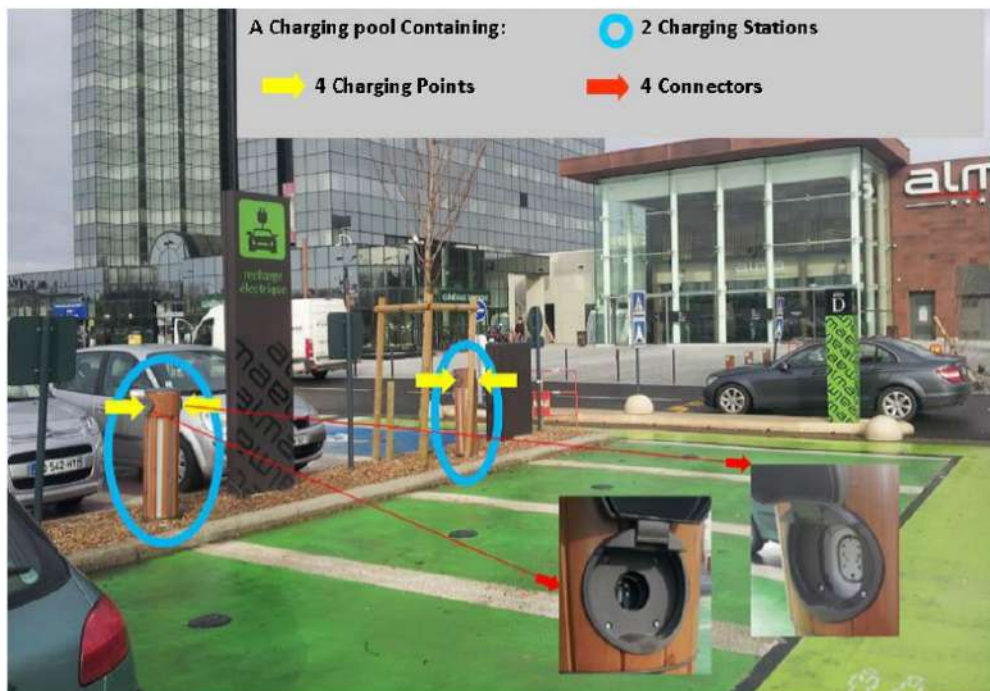

Figure 1.1: A charging pool with multiple charging stations and charging points (NEA, 2019)

1.4 EV Ecosystem Review

The push for Electric Vehicles is driven by the global agenda established under the Paris Climate Agreement to reduce carbon emissions, and by the national agendas, such as improvement of air quality, reduction of dependence on oil imports, and encouragement of the local EV manufacturing sector. Electric mobility necessitates efficient sector coupling between the energy and transport sectors. Decarbonisation of both energy and transport sectors is leading energy transition globally. With declining cost of renewable energy, solar photovoltaic (PV) and wind are increasingly the cheapest sources of electricity in many countries (IEA, 2021a). As the world is transitioning towards clean energy, there is a growing share of variable renewable energy (VRE) which requires innovative measures to effectively manage these resources. One of the solutions is to integrate energy storage into the system to facilitate higher RE penetration without the need of curtailment. As per IEA analysis, by 2050 there will be 14 TWh of EV batteries compared to only 9 TWh of stationary batteries (International Renewable Energy Agency (IRENA), 2019). EVs capable of either unidirectional or bidirectional charging can be used for RE integration. Therefore, an increase in investments in electrified transport is witnessed and policies supporting EVs and charging infrastructure are gaining importance.

In this light, Figure 1.2 illustrates the various stakeholders impacted by the electrification of transport. Although regional performance is varied, the trends and projections indicate that the penetration of EVs will increase rapidly in the coming years as shown in Figure 1.3. The global electric mobility revolution is today defined by the rapid growth in electric vehicle (EV) uptake with an estimated two in every hundred cars sold today, powered by electricity (Hertzke et al., 2019). The global EV fleet crossed the 5 million mark in 2018, having increased by 2 million from the previous year (International Energy Agency, 2019). The EV30@30¹ scenario projects electric two/three-wheelers sales to reach 61 million in 2030. This trend is expected due to a combination

¹ (International Energy Agency, 2019) presents two scenarios for the future development of electric mobility: the New Policies Scenario, which illustrates the impact of announced policy ambitions; and the EV30@30 Scenario, which considers the pledges of the EVI's EV30@30 Campaign to reach a 30% market share for EVs except two-wheelers by 2030.

The New Policies Scenario projects global EV sales to reach 23 million in 2030 with and the stock exceeding 130 million vehicles (excluding two/three-wheelers). The EV30@30 Scenario, projects global EV sales to reach 43 million in 2030 with stock exceeding 250 million.

of factors including lower energy requirement and ease of charge with conventional plugs(International Energy Agency, 2019).

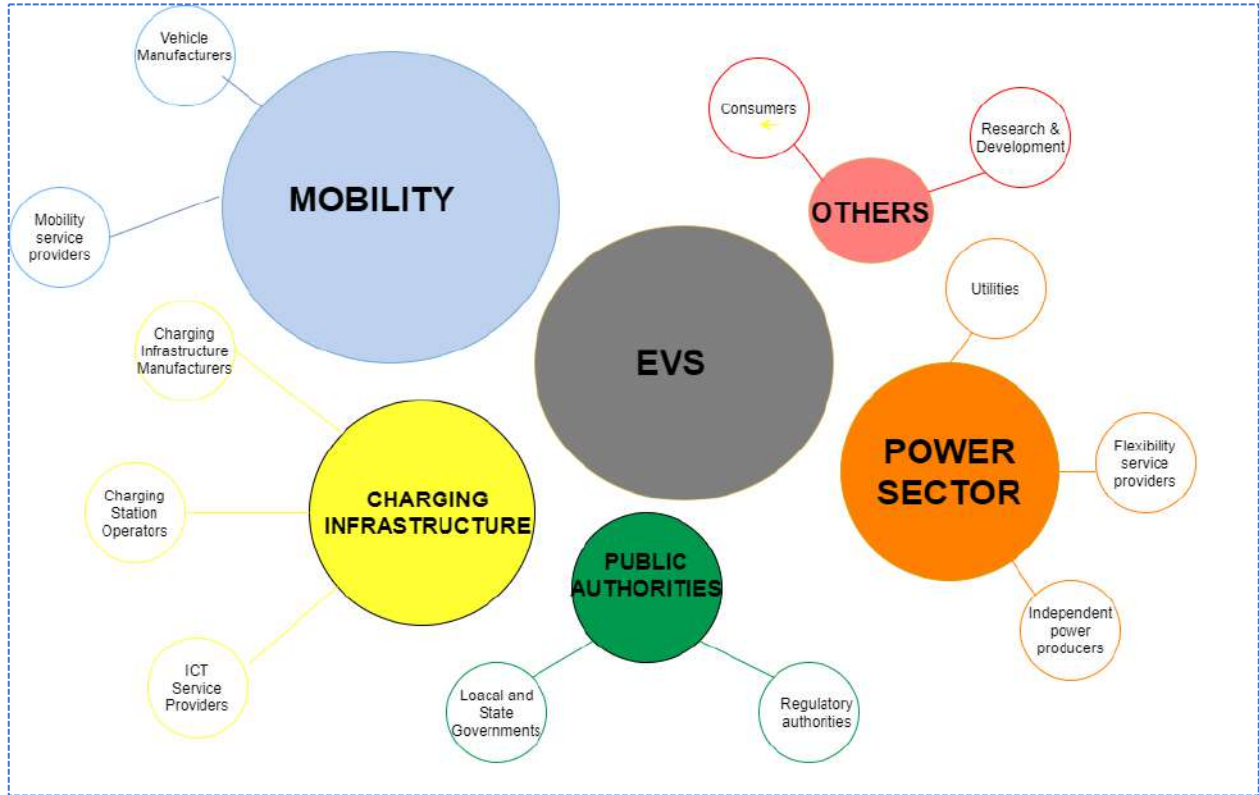

Figure 1.2: Various stakeholders in the electrification of transport

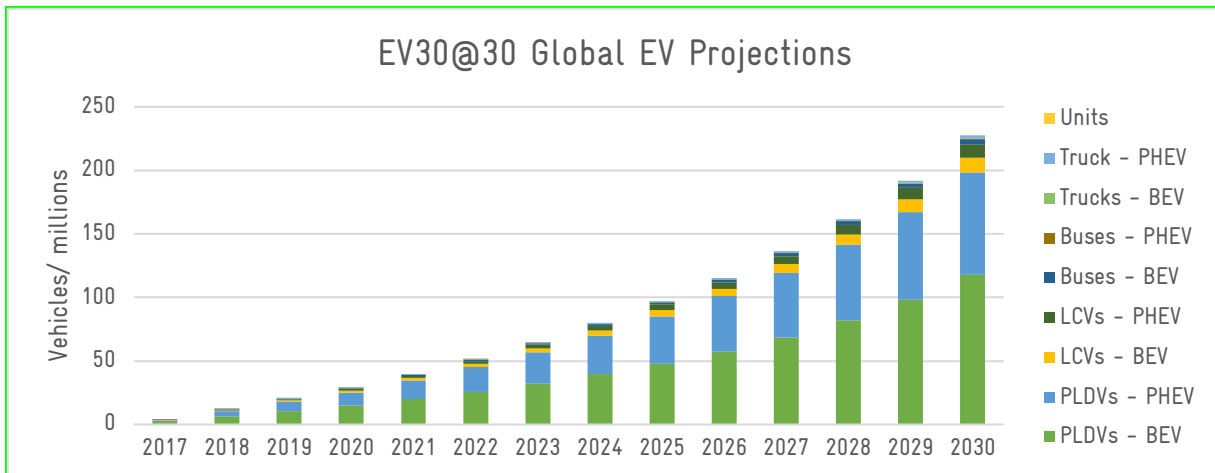

Figure 1.3: EV30@30 Global EV projections (IEA, 2018)

The projected uptake of EVs would have significant impacts on the power sector and global electricity consumption from EVs is expected to reach 928 TWh by 2030 (International & Agency,

2018). The rapid growth in EV uptake required to reach global policy targets will have to ensure the deployment of the charging infrastructure required to serve the needs of the ever-growing number of EVs.

1.5 Global EV Charging Infrastructure

EV charging infrastructure is being rapidly deployed globally. The global stock of EV chargers grew by almost 40% from 5.2 million in 2018 to about 7.3 million in 2019 (IEA, 2020). Of the total stock however, 6.5 million chargers were private chargers.

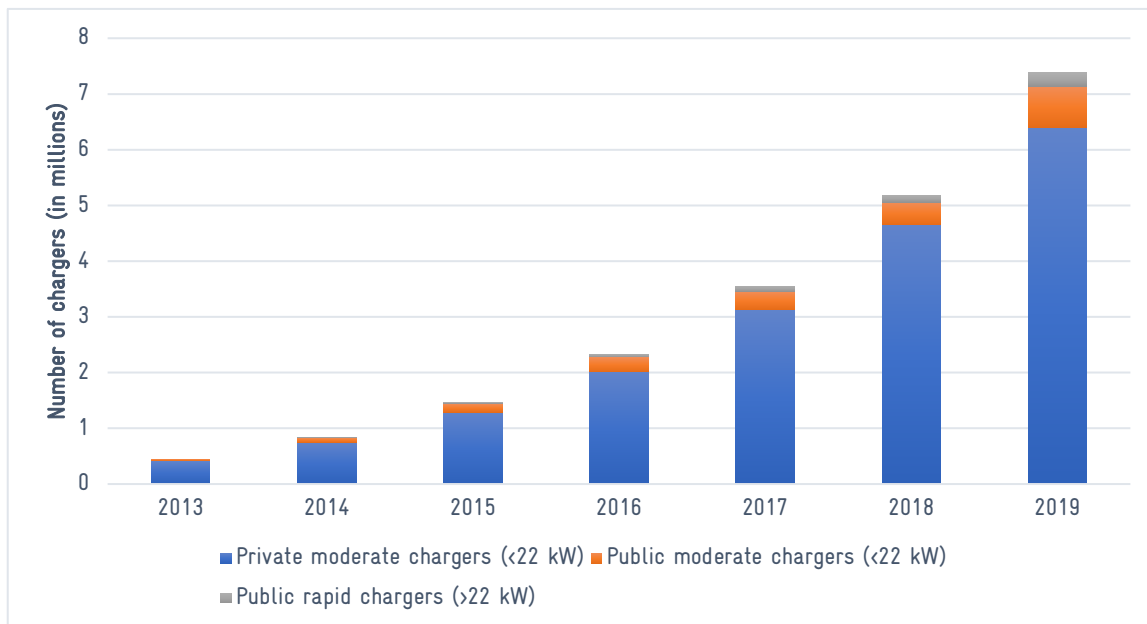

Figure 1.4: Global stock of EV chargers from 2013 to 2019 (IEA, 2020)

As seen in Figure 1.4, the share of private chargers is much more than that of publicly available chargers. Private chargers account for almost 90% of the total global charger count. Each EV is generally provided with its own charger which has helped in increasing the global count of private EV chargers. Further, the convenience of private chargers is another of its primary drivers for prevalence. The installation of private chargers may include residential locations and also chargers in the workplaces. Looking at the global share of private chargers in Figure 1.5, it can be seen that China has the highest share of private chargers with almost 2.4 million chargers. In comparison USA has close to 1.56 million private chargers by 2019.

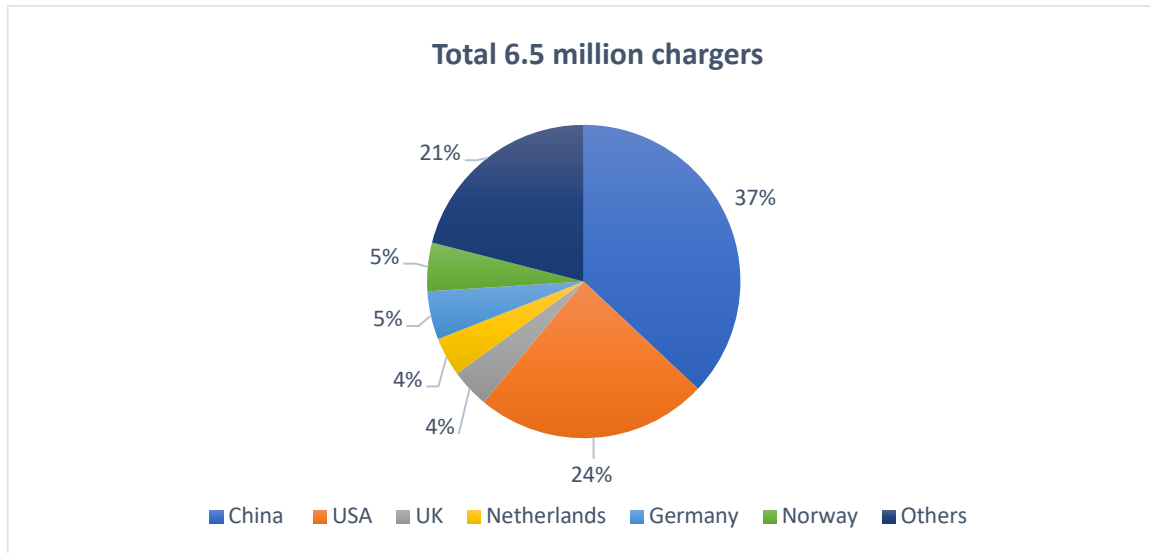

Figure 1.5: Global stock of private chargers by country, 2019 (IEA, 2020)

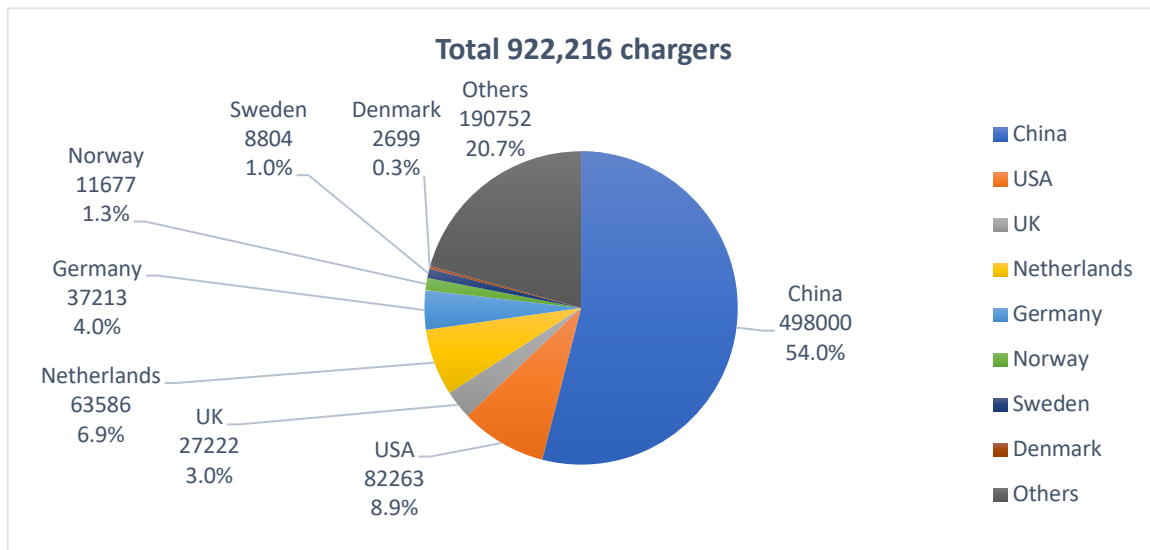

Figure 1.6: Global stock public moderate chargers up to 22 kW by country, 2020 (IEA, 2021b)

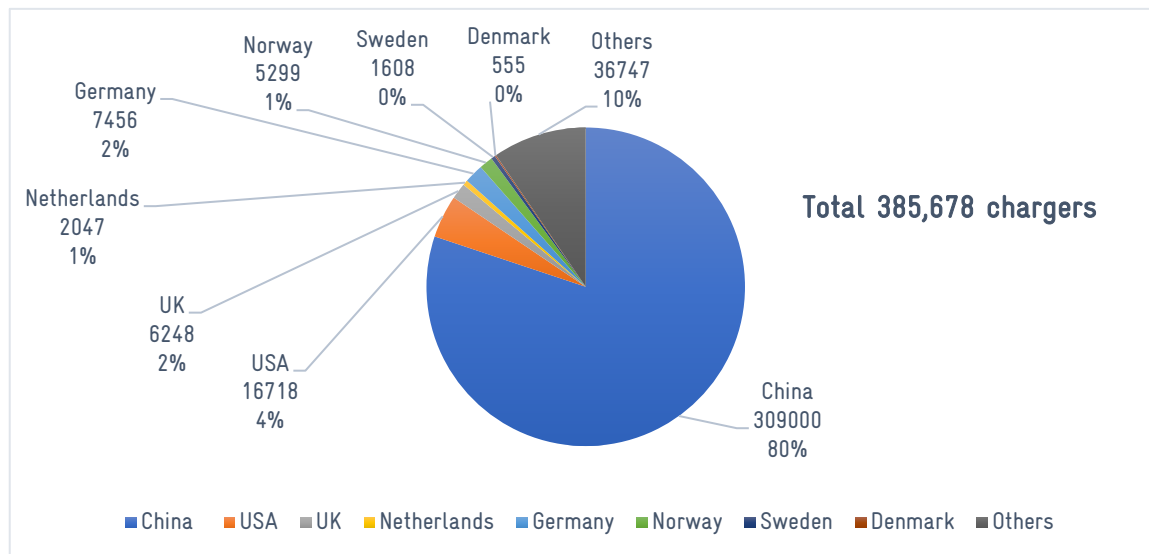

Figure 1.7: Global stock of public rapid chargers higher than 22 kW (IEA, 2021b)

Looking at publicly accessible chargers in Figure 1.6 and Figure 1.7, globally, there are 922,216 publicly available moderate chargers and 385,678 publicly accessible rapid chargers by 2020. With the rapid uptake of electric light duty vehicle (LDV), the number of chargers available per electric LDV decreased from 0.13 in 2018 to 0.12 by the end of 2019. Here too China is leading with close to 54% of global share of publicly accessible moderate chargers and 80% of the global share of publicly accessible rapid chargers.

The EV charging infrastructure really picked up in 2020, with an addition of almost 416,000 charging points solely in 2020 in the top 10 countries which forms almost a 50% increase over the cumulative public charging points till 2019 as given in Figure 1.8.

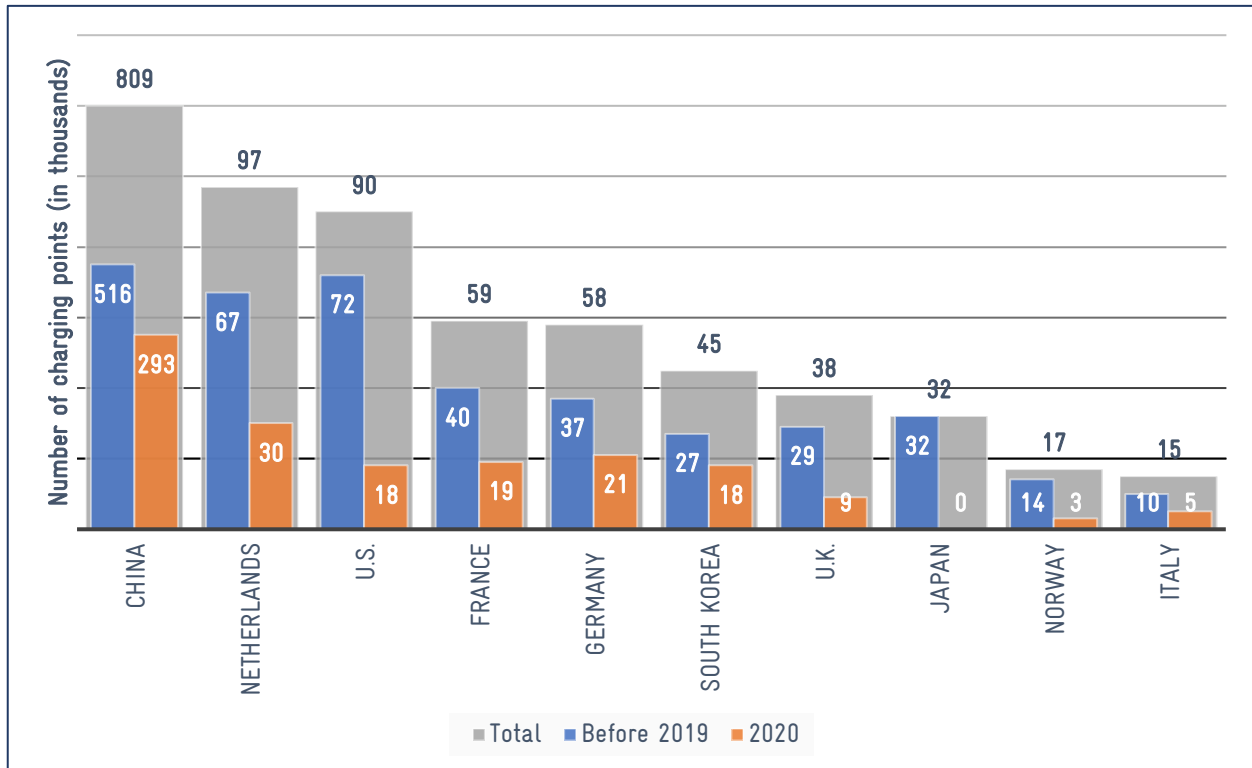

Figure 1.8: Top 10 countries by cumulative public charging connector installations, 2020 (based on Bloomberg's data)

1.6 Electric Vehicle Integration

The continued development of EV charging infrastructure and its integration will depend on the policy and regulatory framework, which must also consider the prospective repercussions of the added EV load in the network, such as increased peak demand and congestion in the distribution grid. While EVs pose a challenge to managing the power system, their controllable and flexible characteristics present an opportunity to provide Vehicle-to-everything (V2X) services.

The swift expansion in the EV adoption strategies required to reach India's policy targets will still require addressing three significant challenges/dimensions.

Required policies and regulatory frameworks to enable the efficient deployment and integration of charging infrastructure

Required technologies and management of the potential impacts of the additional EV load in the power network

Mode of offering grid flexibility services from EVs, and how can they be unlocked

The current public charging infrastructure in India is underdeveloped but with ambitious targets for the coming years. For EV adoption, there exists a chicken or egg problem of which comes first: the vehicle or the charging station? The development of charging infrastructure would be dependent upon the policy and regulatory environment, which in turn would impact the business models that evolve to enable EV charging services.

As the EV adoption grows, the integration of EVs into the power system can raise additional challenges and opportunities. That is, the additional EV load which has unique characteristics of being mobile, power-dense and less predictable can have a significant impact on the power system, leading to higher cost of electricity supply and grid cost due to the capacity required to accommodate the new load.

As the EV fleet size increases, failure to manage EV charging well lead can lead to an increase in peak demand and cause operational challenges for the grid. Simultaneous charging of EVs increases peak demand thus leading to higher energy and system service prices. (Zhang et al., 2014). Secondly, failure to distribute the EV charging locations increases congestion in the distribution grid congestion thus leading to grid asset ageing and service interruptions (Bhagwat et al., 2019). Both of these challenges have potential to increase the cost of electricity supply, create inconveniences for EV charging and ultimately increase the cost of EV ownership. Figure 1.9 illustrates conventional approaches to managing increased peak demand and grid congestion. These conventional approaches by utilities include investing in additional new generation and distribution capacity. In this way peaks are accommodated and grid congestion is reduced thus ensuring adequacy at any time and location of consumption.

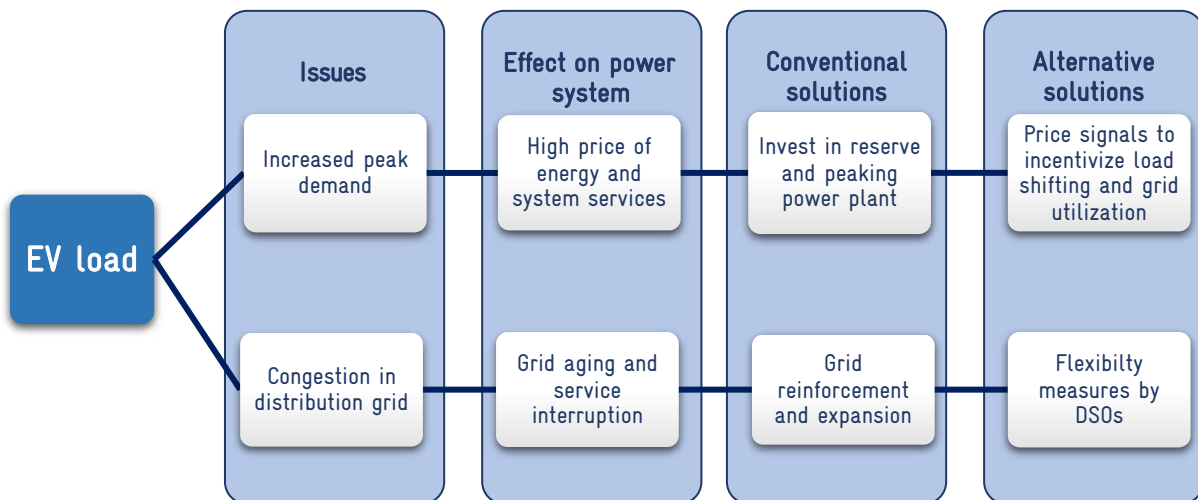

Figure 1.9: Potential issues caused by additional EV load, effects and solutions (P. C. Bhagwat, Hadush, and Bhagwat 2019)

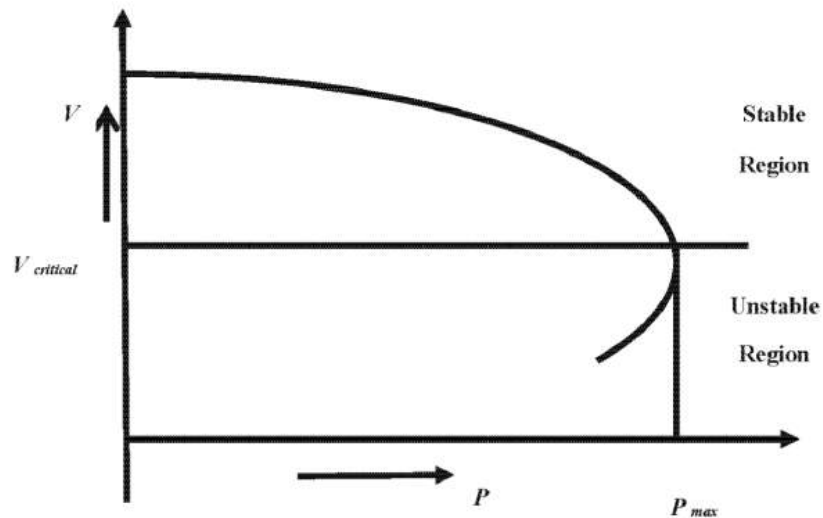

Figure 1.10: Voltage vs active power curve (Deb et al. 2018)

Residential loads in the distribution network are mostly connected at low voltage levels. Residential EV charging too is mainly connected to the LV distribution network, which brings another set of challenges. The relation between active power and voltage of a bus is represented by the PV curve as given in Figure 1.10. It signifies the trend of voltage change with increasing active power. Based on the line resistance and reactance, each bus has a critical voltage where the active power is the highest. The ratio of change in voltage due to change in active power is termed as Voltage Sensitivity Factor (VSF). A high VSF means that even for small changes in

active power, there is a significant drop in voltage and vice versa. EV charging stations introduce large active power demand from the network, and the consumption of power is significantly higher for fast chargers compared to slow chargers. So, an EVCS installed in a bus with high VSF will significantly degrade the voltage at the point of connection. Voltage unbalance issues can also come up due to unequal loading of the three phases. In case of EV charging, if the single phase chargers are not equally distributed among the three phases, voltage imbalances may occur (Weckx & Driesen, 2015). Further as these EV chargers are power electronic devices so they also inject harmonics into the system.

However alternative solutions have emerged to help defer these investments. Instead of investing in reserve and peaking power plants, utilities can send price signals to incentivize EV users to shift EV charging to off-peak hours. Similarly, instead of investing in grid reinforcement, utilities can manage grid congestions proactively or reactively through flexibility measures. These alternative solutions require an enabling policy and regulatory environment as well as various enabling technologies such as advanced metering infrastructure and advanced network management.

In contrast, the controllable and flexible characteristics of the additional load present an opportunity to efficiently integrate not only EVs but also intermittent renewables into the system by providing ancillary services. Apart from the system-level benefits, permitting EVs to participate in the electricity markets would present new revenue generation opportunities for vehicle owners. This, in turn, would further improve the business case for EVs by reducing their total cost of ownership (TCO) as the EV user would receive revenue for providing grid support services.

EVs as flexible sources with V2X capability can offer various V2X services in the future. Currently, the concept of V2X is still in an early stage of development globally. In the context of India, where the EV sector itself is in a nascent stage, V2X services would become relevant in the future when the market is at a mature stage of development. Nevertheless, proactive policymaking will aid in ensuring that the full potential of the V2X services can be utilised.

1.7 Analytical Framework

The development of EV charging policies considers two fundamental perspectives: the supply (developers of EV charging infrastructure and charging service providers) and the demand side (EV users). This report applies the analytical policy framework developed by the Florence School of Regulation (Bhagwat et al., 2019). The various elements to be considered within these perspectives are shown in the table given below.

Table 1.1: Analytical framework for EV charging infrastructure policy

Dimensions	Elements
Enabling EV charging on supply-side	Definition of a fundamental market design framework to limit distortions and entry barriers
	The incentive for launching the EV charging market
	Prioritization in terms of EV characteristics and social geography
	Elimination of administrative barriers for establishing charging stations
	Mandate on user data sharing and privacy
	Mandate on the utilization of V2X capabilities
Enabling EV charging on demand-side	Technical standardization of chargers for inter-operability
	The mandate for the development of digital platforms and database management systems
	Specification of the use of a wide range of payment methods
	Specification of minimum facilities to be provided at the charging stations
	Harmonization of Intra/interstate user registration for accessing charging infrastructure
	Establishment of a mechanism to address consumer complaints

The supply-side constitutes the entities mainly responsible for setting up the charging infrastructure and providing the charging services. Therefore, the first six elements are targeted at qualitatively assessing the presence and extent of these elements enabling the supply side to deploy public charging infrastructure in a particular EV policy. The demand side involves the EV user that would ultimately utilize the charging infrastructure and the services it provides. Therefore, the remaining six elements are applied to qualitatively assess whether and to what extent a particular EV policy enables the “demand-side” in terms of ease of use. EV charging policy can play a critical role in accelerating the adoption of EVs and providing value and convenience to the EV user.

1.7.1 Enabling EV charging on supply-side

The supply side refers to the entities that would eventually set up the charging infrastructure and provide the charging services. The first six elements are therefore aimed at qualitatively assessing whether and to what extent a particular EV policy includes these elements that enable the supply side in the deployment of public charging infrastructure.

A. Definition of a fundamental market design framework to limit distortions and entry barriers

For the efficient functioning of a market, it is essential to develop clear and precise policy decisions and market design frameworks from the start, minimizing market distortion and entry barriers. With regards to EV charging, this could potentially include the level of competition allowed and the price-setting approach.

A rudimentary choice is the introduction of competition which can be broadly introduced using two techniques. The first technique is the in-market competition, which allows establishing infrastructure and its commercial provision by any entity. The second technique is competition for the market. A competitive bidding process is used to award the winner a time-limited concession to set up charging infrastructure and provide services within a particular area. The policymakers also have the choice to mandate the state-owned utility to set up and operate charging stations. A combination of various techniques can also be considered if needed.

Another critical element is the principle for EV charging price setting. The policymakers can choose between a fully regulated price, a fully market-based price-setting or a price cap. After the elementary design choices are made, the policy is also required to mandate changes to incumbent regulation (such as open access, deregulation of electricity retail, etc.) to minimize entry barriers.

B. Encouragement for launching the EV charging market

The causality dilemma of whether the EV or the charging infrastructure needs to come first has long been a much-debated topic (Gnann et al., 2015, 2018; Meeus, 2017; Perkowski, 2016; Transport and Environment, 2018). However, global experiences make it clear that the thrust has to arrive from either side. Therefore, initially, incentives for installing charging stations and necessary innovation are required to launch the market are of utmost importance.

The level and kind of incentive would depend upon a given state or country's social, economic and political priorities. However, the EV policy needs to clarify whether or not an incentive for launching the EV charging market is to be provided to enable the rollout of charging infrastructure. If provided, then its boundary conditions (limits) must be specified as the minimum criteria.

C. Prioritization concerning EV characteristics and social geography

The implementation of charging infrastructure can follow two methods: a coverage-based method to charging infrastructure spanning an entire region and a demand-based method for the charging

infrastructure deployment to follow demand. Hence, a choice needs to be made concerning social geography (see Section 1.1).

Another component that might influence EV charging is the EV attribute (chassis and engine). For instance, the charging requirements of an electric bus fleet would show a discrepancy from that of electric scooters concerning speed, location, method, and ownership. Similarly, *ceteris paribus*, the charging frequency needed for an EV would vary depending on battery capacity. These nuances ought to be taken into consideration throughout policy development.

Hence, an innovative EV charging policy should provide a road map with the short, medium, and long run of the priority in the context of the EV characteristics (the priority of electrifying various modes of transport) and information on the target social geography (factors impacting the choice between coverage, demand, or mixed approach?).

D. Eradication of administrative barriers for establishing charging stations

Like setting up any new business, any entity to set up a public EV charging infrastructure needs to acquire several clearances and permissions (e.g., permission for land use) and are mostly handled by several different agencies that may or may not function in unison. Thereby, there is a likelihood of unforeseen delays and inefficiencies in establishing the infrastructure and building barriers to market entry. Therefore, the EV policy must embody provisions that identify and avoid administrative barriers to the inception of charging stations.

E. Mandate on user data sharing and privacy

Ingenious and quick innovation in information and communication technologies has paved the way for new opportunities and challenges in all sectors, including power and energy. One of the crucial discussions on this domain has been relating to the use and protection of consumer data and data privacy. In the European Union, the right to protect personal data is fundamental (Regulation (EU) 2016/679 of the European Parliament and of the Council of 27 April 2016 on the Protection of Natural Persons with Regard to the Processing of Personal Data and on the Free Movement of Such Data, and Repealing Directive 95/46/EC (General Da, 2016).

The EV charging industry could potentially clash with similar issues in the upcoming years. Technologies like smart chargers and smart grids would enable service providers to garner extensive data on consumer choices and behavior, which can be a valuable resource for the service provider to optimize its operations, and its value could be monetized. However, there is also a significant threat of unauthorized misuse of consumer data. The privacy concerns arising from 'big-data' are discussed in detail by (Tene & Polenetsky, 2013). Hence, the EV policy must

acknowledge and mandate the development of a regulatory framework to govern consumer data and protect consumers' privacy.

F. Mandate on the utilization of V2X capabilities

For unlocking the full potential of the V2X services that the EVs can provide, the EV charging policy must provide a comprehensible direction on the initiation of regulations and guidelines on different aspects of the V2X services. This would clarify the possible service providers, network operators, and other consumers of these services. It is to be noted that V2X is still in an early stage of development and would potentially gain greater relevance in the future.

1.7.2 Enabling EV charging on demand-side

The demand side involves the EV user who would ultimately use the charging infrastructure and its services. Therefore, the remaining six elements are applied to qualitatively assess whether and to what extent a particular EV policy enables the “demand-side” in terms of ease of use.

A. Technical standardization of chargers for interoperability

Interoperability of charging infrastructure is crucial in enabling the demand-side (DG-IPOL, 2018; Hall & Lutsey, 2017). The critical element of interoperability is the technical standard used for the charger. In general, charger standardization can either take place in a top-down or bottom-up approach. In the former, the concerned authority specifies standards and charging service providers must provide at least the standard chargers, thus ensuring interoperability. The latter is more evolutionary where no standards are specified, and eventually, a dominant or consensus design emerges, which becomes the standard over time. In either situation, the EV policy needs to specify the approach that is to be followed.

B. Directive for the development of digital platforms and database management systems

The rapid innovation in information and communication technologies has provided users with instant access to information in a distinctive way. Any activity from banking to shopping requires digital platforms like websites and mobile applications regularly.

In EV charging, these systems can be utilized to provide the EV user with detailed information on the charging network. This data could range from the identification of the nearest charging point to reserving it and beyond. Thus, digitalization has a positive impact on enabling the demand-side. Therefore, the EV policy can mandate the development of these digital platforms and define their basic functionality. See (Glachant & Rossetto, 2018) for a discussion on how digitalization plays out in the electricity sector.

C. Specifications related to the use of a wide range of payment methods

Today, consumers have widespread access to multifarious payment methods that go beyond just coins and notes and include different modes of online currency. The payment method preference among customers may differ depending upon constraints on a case-to-case basis. The availability of a broad range of payment options available at the charging station would positively impact the demand-side and could be promoted through the EV policy.

D. Specification of minimum facilities to be provided at charging stations

Like most services, there must be a minimum standard and quality of facilities for consumers. Having minimum requirements would positively impact the demand side since the consumer would know what to expect at the charging station. For example, specifying the minimum vehicle parking space requirement within the charging policy will also guarantee that the owner of a large SUV is assured of having sufficient parking space during charging. Hence, this factor will play a key role in enabling the demand-side. Thus, the EV policy must consider minimum standard facilities and their quality at a charging station.

E. Harmonization of intra/interstate user registration for utilizing charging infrastructure

The long-distance and cross border usage necessitate more than just compatible physical infrastructure. Different countries and states will most certainly have different market designs and charging service providers. Thus, depending upon the regulation, these charging stations may require EV users to register with each of these service providers separately, following their processes and requirements. This issue may also come up in an intra-state context with an in-market competition where separate suppliers will ask for independent registration.

An unharmonized registration system can create an obstacle on the demand side and hinder EV adoption. There will be a hint of doubt among EV users on whether they would charge the vehicle when crossing borders and driving over long distances in an inter-state context. In addition, EV owners may or may not comply with the varying registration requirements in different states or suppliers. In an intra-region context, an unharmonized registration system can also restrict the access of EV users to charging stations constructed only by the companies with which the users are registered.

F. Setting up of a mechanism to address consumer complaints

Attending to consumers' concerns rapidly and efficiently would lead to greater trust in the functioning of the public charging services. Most commercial establishments have mechanisms for addressing complaints in today's competitive environment with widespread access to social

media. However, forcing the establishment of a robust mechanism to address consumer complaints (in a time-bound fashion) within the EV policy would ensure validity to the existence and quality of such a mechanism instead of leaving it to the discretion of the service provider and enabling the demand-side further.

This study will review eight international countries and eighteen Indian states using this framework to identify the gaps in EV integration, unlock its full benefits, and helping reach India's ambitious EV targets.

1.8 Stages of market development

The development of a robust charging infrastructure is necessary to support the rapid and growing uptake of EVs. An understanding of the different stages of market development is key to identifying possible avenues of innovation to ensure the existence of viable business models for the provision of commercial charging services.

The authors in (Bhagwat et al., 2019) emphasize the need for policy makers to correctly determine the stage of market development in order to prescribe suitable policy recommendations. The three stages of EV market development include, introductory, growth and maturity stage. The introductory stage is characterized by a low product awareness and limited-service providers on the market. In the context of EVs, this can be extrapolated as limited commercial charging stations and few EVs in operation. India is an example of an EV charging market in its introductory phase with an EV-adoption rate of less than 1% (Hertzke et al., 2020).

The growth stage is characterized by a growing EV uptake as evidenced by the number of registered EVs in a country. The steady increase in the number of EV users also implies more charging service providers in the market. Due to increased competition in this stage, the focus is on increasing market share and consumer convenience through innovation. EV charging infrastructure businesses begin to incorporate more value-added services in their product portfolio (Bhagwat et al., 2019).

The countries considered in this review have made great strides towards the deployment of EV charging infrastructure. As shown in Figure 8, EV charging markets in **The Netherlands, Germany, Denmark, the Republic of China, Norway, Sweden, the United Kingdom, and the United States of America** are in the growth stage of market development. This is characterized by partnerships for specialization or increased access, innovative subscription offering, service innovation such as green power, multiple-speed, multi-charging (Bhagwat et al., 2019). In the growth stage business innovation to improve effectiveness of price signals and acceptability of

time varying tariffs is also prevalent. However as shown in the following chapters, the stages of policy development, charging infrastructure deployment and targets, level of competition varies from country to country.

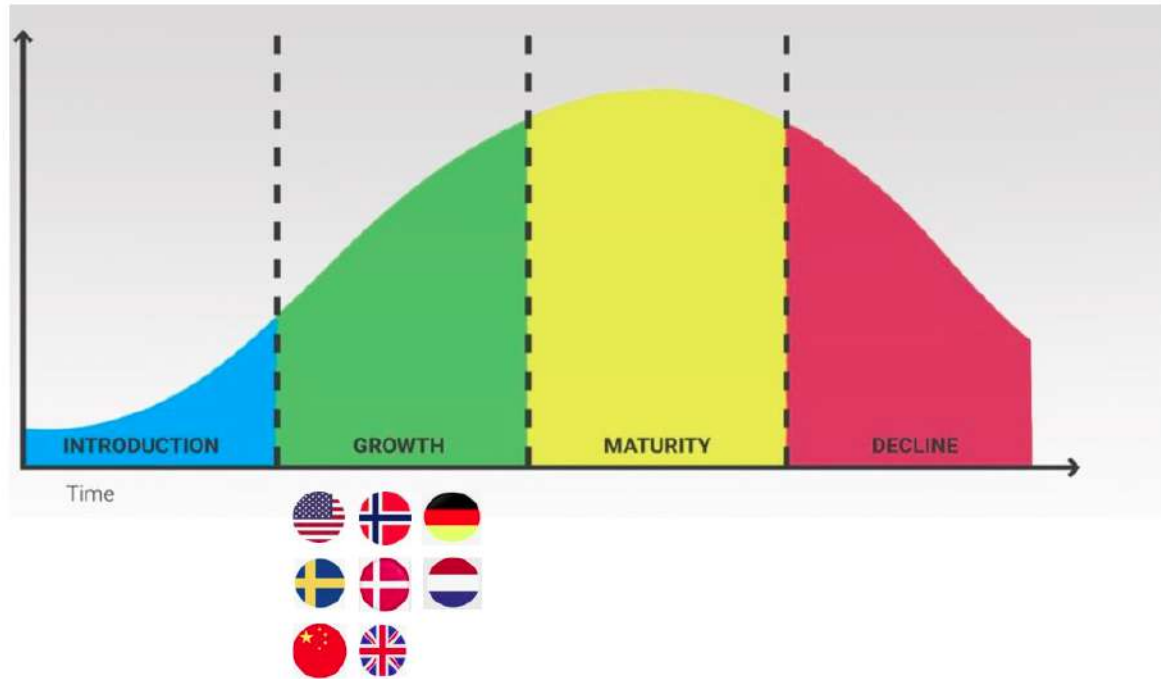

Figure 1.11: Stages of EV market development

The mature stage is characterized by achieving a critical mass of EV charging station adoption. In this stage the product is commonly in use and the significant prevalence of EVs will generate greater revenues for EV charging service providers. Additional gains of market share will be extremely costly, and barriers to market entry would be high (Alternative & Observatory, 2018). No EV charging market is yet in the mature phase.

Chapter 2. United Kingdom

2.1 Background for policy making environment

The British Government is actively promoting the growth of BEV and PHEV market through various grants, schemes, and other incentives. In 2008 the British Prime Minister Gordon Brown announced plans for Britain to be at the forefront of a 'green car revolution' in the G8 summit. He laid down an aggressive goal of all new cars sold in Britain would be either hybrid or electric with tailpipe emission of less than 100g of CO₂ per kilometer of travel by 2020. Local councils were also invited to bid for awards and incentives in terms of financial aid to become green. The transport for London (TfL) also announced that all new taxis must be zero-emissions capable by 2018. As of November 2013, the UK government pledged INR 4,096 crore (EUR 465 million²) for faster adoption of EVs, however as of June 2014, there were about 3000 plug-in vehicles in London which was only 3% of the then mayor's and TfL goal (BBC News, 2014; Gov.uk, 2015). As a result, in Jan 2014, the 'Go Ultra Low' national campaign was launched by the UK government in partnership with the five largest manufacturers of PEV vehicles: BMW, Nissan, Renault, Toyota, and Vauxhall. In 2011 and 2012, two new incentive schemes were started for the purchase of EVs, the Plug-in Grant program which provided a 25% grant towards the cost of new plug-in cars, and the Plug-in Van Grant which provided a cost rebate of 20% (up to INR 8.19 lakh (EUR 9310)) of the cost of the plug-in van (Gov.UK, 2012).

On 10th March 2021, the UK govt. allocated INR 204.8 crore (EUR 23.27 million) fund for innovation in electric vehicle sector (GOV.UK, 2021). For this the govt. launched a research and development competition which could include innovations in zero emission emergency vehicles, charging technology, EV battery recycling etc. In one of such earlier R&D competitions, the UK govt. has awarded INR 30 crore (EUR 3.49 million) to the start-up firm Urban Foresight which came up with the innovative idea of 'hidden' on-street charging points, that would rise out of the pavement to serve EV drivers as shown in Figure 2.1 (Middleton, 2021).

² EUR 1 = INR 88.08



Figure 2.1: Hidden on-street charging points by Urban Foresight (GOV.UK, 2021)

A proposal to end the sale of new petrol and diesel cars (including hybrids and plug-in hybrids) by 2040 was announced in 2018 as part of the government's strategy to reach net-zero carbon emissions by 2050. This ambition is supported by the "Automated and Electric Vehicles Act 2018". The first part of the act establishes that insurers are required to deal with all claims even when the vehicle is operating in automated technology mode and the second part of the act deals with the electric vehicle charging infrastructure including issues such as availability, compatibility vehicle types, reliability standards and standardizing how they are paid for.

In 2019 Committee on Climate Change (CCC) expressed their concern that the original 2040 date was not soon enough to meet the net-zero target, calling the government to support the charging infrastructure, particularly for drivers without access to off-street parking.

In February 2020, the prime minister Boris Johnson said he was bringing forward a ban on the sale of new petrol and diesel cars from 2035 to 2040 including the plug-in hybrid vehicles. Following a lengthy consultation and a push for more ambitious action on climate change, in November 2020 the Government has confirmed that the ban on new petrol and diesel cars is moved forward to 2030, 10 years earlier than planned (Vaughan, 2020). There are exceptions to the ban, some plug-in hybrids, and some full hybrids still able to be sold up until 2035. At the same time, it was announced a new INR 205.5 crore (EUR 23.3 million) funding for electric vehicle innovation. The government has also pledged to spend INR 5,138 crore (EUR 0.58 billion) in the next four years for the development of mass-sale EV battery production in the UK. This commitment is part of a wider INR 10,275 crore (EUR 1.17 billion) package to boost investment in UK manufacturing bases including giga factories. The UK government has also targeted to achieve 100% zero emission vehicles by 2035. In order to achieve the target, a roadmap has been

created as shown in Figure 2.2. For the development of charging infrastructure to cater to the EV charging load, Ofgem is considering the possibility of socializing the network reinforcement costs among all the electricity bill payers (HM Government, n.d.).

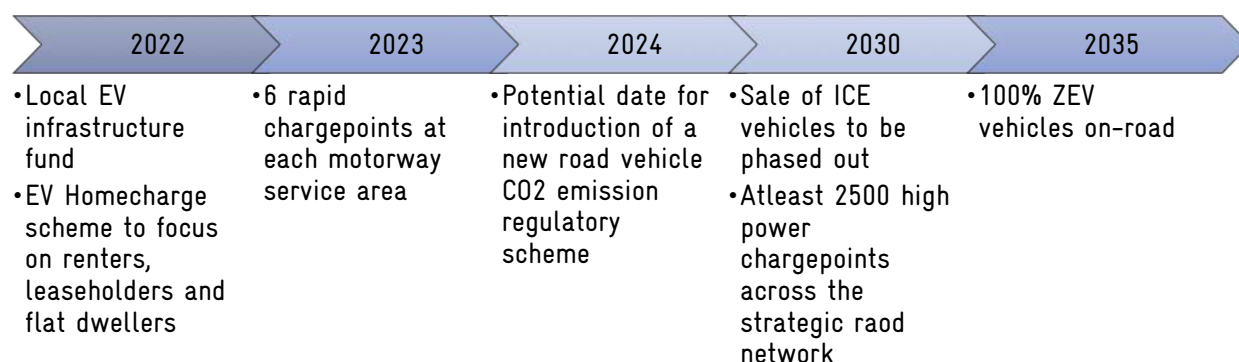

Figure 2.2: Roadmap for achieving 100% ZEV by 2035 (HM Government, n.d.)

Britishvolt will invest a total of INR 26,625 crore (EUR 3.02 billion) in a project to build the UK's first lithium-ion battery giga plant and the company is aiming to have the plant up and running by the end of 2023. Britishvolt says it will produce 300,000 lithium-ion battery packs each year, which will be used to supply the UK automotive industry. Britishvolt will partner with German giant Siemens in this ambitious project.

Highways England has a commitment of INR 153.6 crore (EUR 17.46 million) to ensure there are charge points, particularly rapid chargers where possible, every 20 miles on 95% of the Strategic Road Network by 2020 and it was awarded INR 28.6 crore (EUR 3.26 million) to achieve this target.

2.2 EV Charging infrastructure policies and regulations

Policies Enabling EV charging on supply-side		
Element	Policy Instrument	Measures
Definition of a fundamental market design framework to limit distortions and entry barriers	Road to Zero strategy	<p>The government will use a combination of:</p> <ul style="list-style-type: none"> • Targeted grants and subsidies for the installation of charging infrastructure, as well as research and development in the field. Including reserving the right to make significant further investments in areas of market failure.

		<ul style="list-style-type: none"> • Fiscal incentives for those seeking to offer charge points. • Reform of the planning system to include charge points in new developments, wherever appropriate. <p>Enforcing the provision of "smart" charge points to mitigate potential grid impacts from mass adoption of electric cars³.</p>
The incentive for launching the EV charging market	Electric Vehicle Home Charge Scheme (EVHS) and Workplace Charge point Grant (WCS)	<p>Manufacturers of electric vehicle charge point units are obliged to apply for their charge points to become authorized under the Electric Vehicle Home Charge Scheme (EVHS) and Workplace Charging Scheme (WCS).</p> <p>The EVHS provides a grant of up to 75% towards the cost of installing EV charge points at residential properties.</p> <p>The Electric Vehicle Home Charge Scheme (EVHS) is a grant that provides a 75% contribution to the cost of one ChargePoint and its installation. A grant cap is set at INR 35.8 thousand (EUR 407) (including VAT) per installation. A person may apply for 2 charge points at the same property if they have 2 qualifying vehicles. The grant is only for retrofit (existing) properties; it cannot be used for new-builds or properties that are not occupied.</p> <p>The Workplace Charging Scheme (WCS) is a voucher-based scheme providing support towards the up-front costs of the purchase and installation of electric</p>

³ <https://pod-point.com/guides/business/road-to-zero-business>

		<p>vehicle charge points. The contribution is limited to the 75% of purchase and installation costs, up to a maximum of INR 35.8 thousand (EUR 407) for each socket, up to a maximum of 40 across all sites for each applicant.</p> <p>The minimum technical specification for the Workplace Charging Scheme has been updated. Charge point models under 'fast DC' with a charging output greater than 3.5kW and not greater than 22kW are now eligible</p>
	Rapid Charging Fund	Allocation of INR 9,828 crore (EUR 1115.8 million) to support the rapid charging network development. Grid capacities will be upgraded at these locations.
	On-street Residential Charge point Scheme (ORCS)	Provides funding towards 75 per cent of the cost of installing on street charging points. Local authorities are invited to submit applications for grants of up to INR 6.65 lakh (EUR 7566) per charge point. Any applications for greater than INR 6.65 lakh (EUR 7566) will be considered on a case-by-case basis.
Prioritization in terms of EV characteristics and social geography	On-street residential charge point scheme	<p>Provides grant funding for local authorities to install publicly accessible, on-street charging points for use by electric vehicle drivers in their area.</p> <p>Funds are made available to local authorities to install the charging infrastructure.</p> <p>OZEV reserves the right to prioritize applications from local authorities installing infrastructure in areas with particular air quality challenges.</p>
	Highway charging	Highways England has a commitment of INR 154 crore (EUR 17.48 million) to ensure there are charge

		points (rapid where possible) every 20 miles on 95% of the Strategic Road Network by 2020.
Mandate on user data sharing and privacy		An existing safety and data privacy framework would apply to smart charging, such as regulations for electrical installations and requirements under the General Data Protection Regulation (GDPR) Data Protection Act 2018. However, the government is in the process of making a specific inclusion under the Automated and Electric Vehicles (AEV) Act 2018 focused on smart charging.
Policies Enabling EV charging on demand-side		
Element	Policy Instrument	Measures
Technical standardization of chargers for interoperability	Standard	<ul style="list-style-type: none"> • BS EN 61851-1:2019 standard defines the different modes for electric vehicle charging. • Mode 3 and 4 are specialized systems for EV charging running from a dedicated circuit. • Mode 1 and 2 use non-specialized infrastructure (e.g., the domestic socket). • Mode 1 provides no residual-current device (RCD) protection and is not considered safe, whilst Mode 2 provides RCD protection but charging power will often be limited by vehicle protocols to charging at 1.4kW to 2.3kW • Equipment installed shall meet the applicable minimum IP ratings set out in BS EN 61851-1:2019 and BS 7671:2018 according to the usage location. • IET Wiring Regulations – currently BS 7671:2018+A1:2020

		<ul style="list-style-type: none"> The recommendations of the IET Code of Practice for Electric Vehicle Charging Equipment Installations
Specification of minimum facilities to be provided at charging stations	National Building Regulations	<ul style="list-style-type: none"> All new residential buildings or buildings undergoing material change to residential use, with an associated parking space must include an EV charge point. All new residential developments with more than ten car parking spaces should have electrical cable routes for EV charge points to every parking space.
	The London Plan	The London Plan specifies the proportion of “active” and “passive” provision of charge points in different development types (residential, retail and employment uses).
	Edinburgh Design Guide (2017)	Requires rapid charging (50kW) provision for all non-residential developments with 10 or more spaces.
	Ultra-Low Emission Taxi Infrastructure Scheme	Awards to local authorities for low emission charge point infrastructure

On the supply side, The UK government has been proactive in ushering EV charging infrastructure rollout and in also ensuring the integration of it into the network. In addition, the government roadmap also clearly includes the consideration of smart charging, which is key to unlock future services benefiting the consumer, service provider and network operators. The smart charging policy will include, data privacy, guidance for interoperability, consumer uptake and grid stability services. In terms of establishment of charging stations, the government via its various schemes is ensuring access to charge points both at residential and commercial locations. There is also a special focus on connectivity for long range mobility via highways. The government has been pushing for charging market development via various incentives schemes such as EVHS, WCS and has made it mandatory for all charge point providers to register in order for them to be eligible to provide service. On the demand side, there are technical standards for different

modes of charging and for future services like V2G, international standards are adopted. To speed up the uptake of EV charging infrastructure, local authorities are playing an important role in defining the charge points, and for all new buildings the government mandates inclusion of EV charge points to cater to future demand. London and Edinburgh have already established specific guides and plans to ensure uniform spread of charge points across the geography.

2.3 EV Charging infrastructure

The UK has seen a rapid growth in its public charging network in the last decade. These public chargers in the UK are equipped with different power rating chargers which have been classified as stated below and applicable in UK:

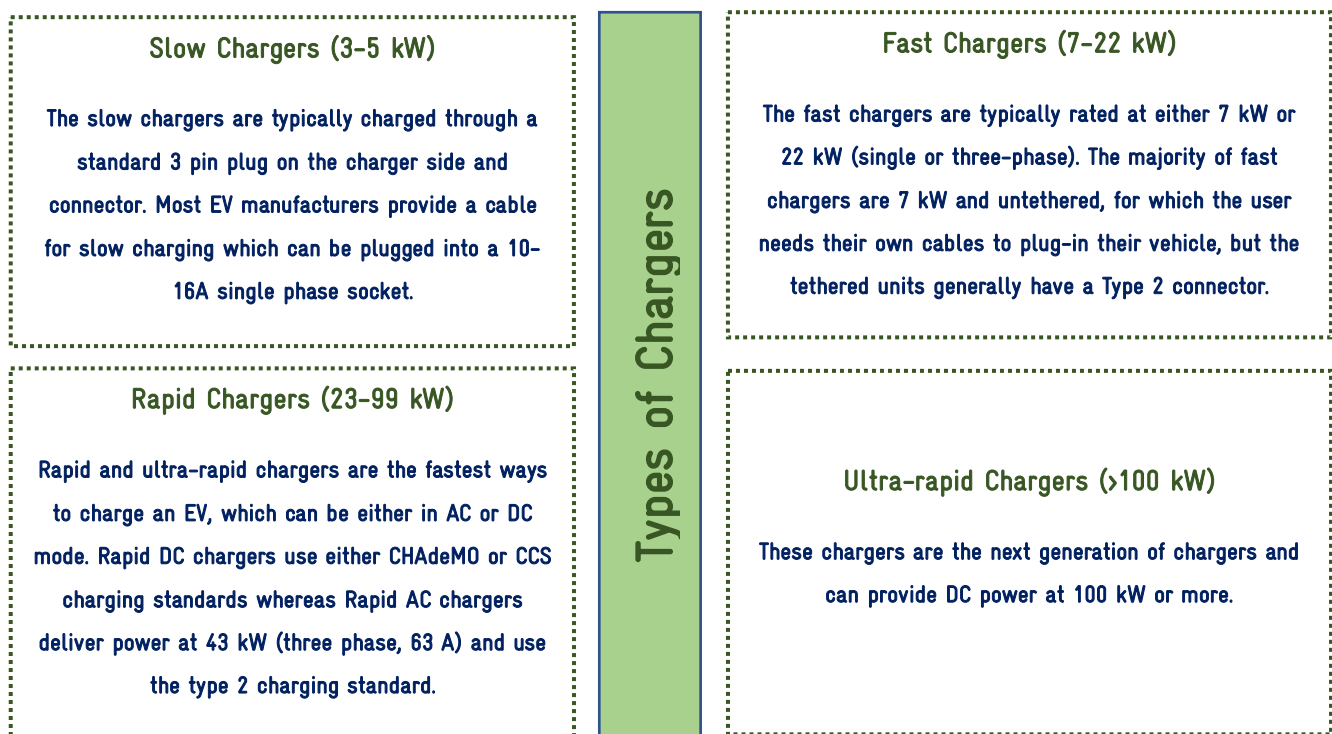

Based on the UK specific EV charging classification described above, the growth of public charging infrastructure in UK has been shown in Figure 2.3. It can be observed that in 2011 and 2012, the number of slow EV chargers was higher than other types of chargers, however, ever since, the charging stations with fast chargers have gained popularity. As of 2020, there are 19955 fast chargers in the UK, with 7328 slow chargers, 7938 rapid chargers, and 1346 ultra-rapid chargers. Fast chargers generally have a Type 2 connector, but rapid chargers can have either Type 2, CCS, CHAdeMO, or Tesla Supercharger connector. The share of different connector types among the rapid chargers in the UK is given in Figure 2.4. CCS and CHAdeMO chargers

have an almost equal share between them at 3039 and 3209 chargers, respectively. There are 1067 Tesla chargers, and the rest 1970 chargers are equipped with a Type 2 connector.

It is also important to note that, Siemens recently completed the UK's first residential avenue to be fully converted to lamppost charging. 1300 lampposts in London have been retrofitted to provide on-street charging. These lampposts are fitted with slow Type 2 AC charger with power rating of 4.6 – 7.4 kW, for which the cable needs to be arranged by the EV user (*Use of Street Lighting for Electric Vehicle Charging*, 2019). In the case of the UK, the number of EVs per public charge point is close to the EU target of 10 EVs per public charge point as shown in Figure 2.6.

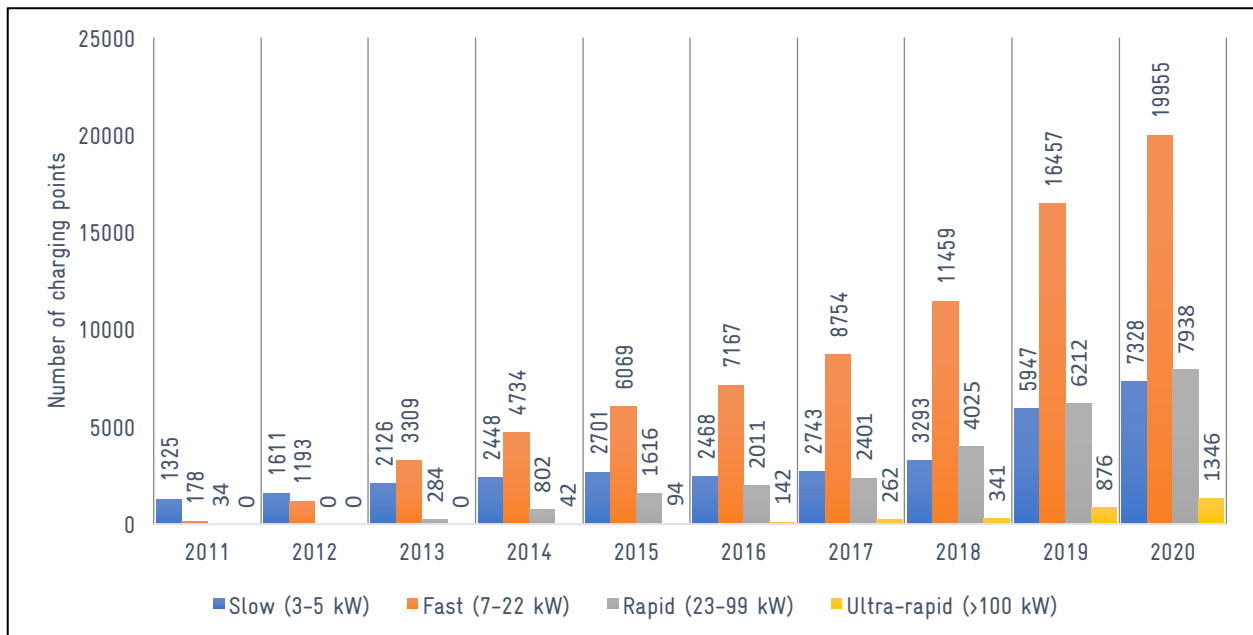

Figure 2.3: Growth of Public charging point by speed (2011 - 2020) (Zap-Map, 2021)

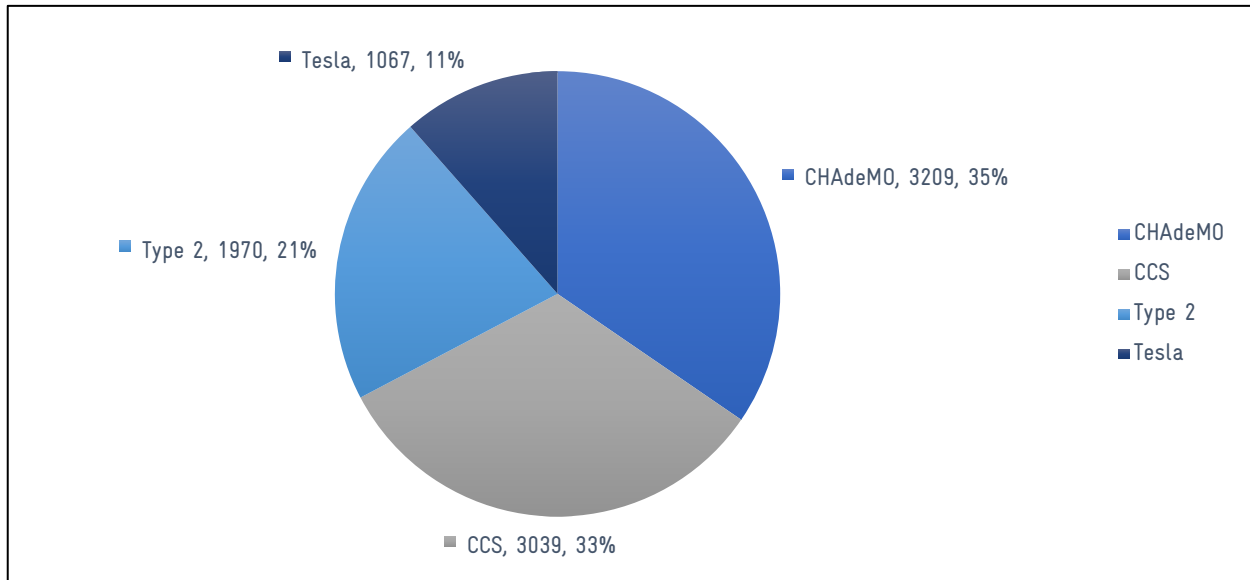

Figure 2.4: Share of connector types among rapid public chargers till 2020 (Zap-Map, 2021)

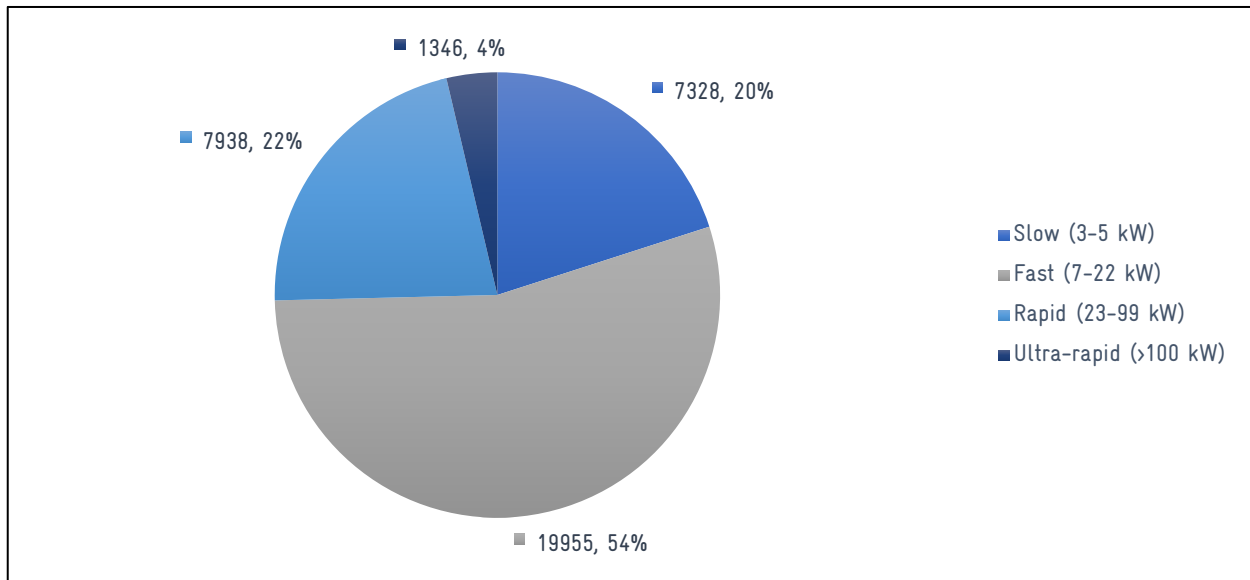

Figure 2.5: Pie chart showing share of public chargers as per charging speed in 2020 (Zap-Map, 2021)

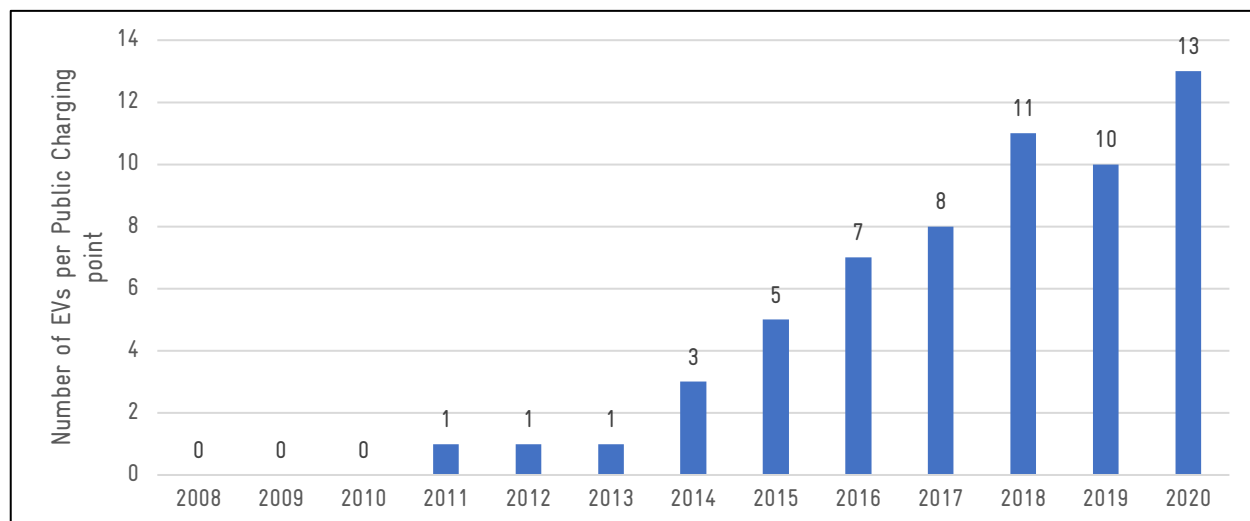

Figure 2.6: Number of EVs per public charging point in UK (United Kingdom, 2021)

In case of residential landscape, 23% of the UK population reside in individual private residences, 30% in two-dwelling residences, and 46% in three or more dwelling residences. By 2019, 40% of the EV fleet belonged to the users residing in individual private homes, 43% in two dwelling residences and 17% in three or more dwelling residences. So, the early EV adopters had access to private driveways and parking spaces, which resulted in 85% of EV owners having access to private EV charging facilities. Compared to the projected scenario in 2030, when the electric vehicle sales is expected to reach 70% of annual passenger vehicles sold, the distribution of EV among the different residence types is given in, the share of EV users with access to private charging is expected to reduce to 80% (Nicholas & Lutsey, 2020).

As of 2019, there are approximately 0.26 million private EV chargers in UK (IEA, 2020), with almost all EV owners expected to have an EV charging cable that can be plugged into any standard outlet, or a dedicated EV charger supplied by the EV manufacturer.

Table 2.1: Distribution of UK population and EVs among different residence types (Nicholas & Lutsey, 2020)

	One-dwelling buildings	Two-dwelling buildings	Three or more dwelling buildings
Percentage of people in different residence types	23%	30%	46%
Passenger EV stock by residence type in 2019	40%	43%	17%
Projected passenger EV stock by residence type in 2030	31%	35%	34%

The distribution and transmission networks were not initially designed for EV demand from homes. Three TNOs and six DNOs are responsible to ensure that the networks are prepared for the predicted uptake of EVs. The demand at the transmission level is highly aggregated and consists of a mix of residential, business, and industrial demand. Therefore, if the supply demand in towns and villages can see a significant increase in the peak demand because of EVs charging, the diversification of demand across transmission assets will help to limit the overall percentage change.

It is not clear yet the dominant charging mode, domestic or public/business charging coupled with mass smart charging for making a clear prediction of the expected peak demand.

At the distribution level private residences with detached houses would be able to install their own private chargers. In the UK, a typical household is permitted to use ~20kW (80-100A) at any time, defined as per their contracted demand as well as their fuse rating. This could be enough power for most appliances to be used at the same time, for example and EVs charger typically draws a maximum of 32A. However, for older houses an upgrade is required and upgrade local networks where spare capacity is limited.

At present, network operators are responsible for their demand forecasting and TNOs are reliant on the forecasts from DNOs to understand future demand. Since we are entering a period of significant change in demand patterns this is an area for innovation to build advanced tools to predict the new demand supported by more effective data collection.

Wider benefits can be provided through EV charging schemes and a number of projects trialed the ToU and smart charging option offered through an aggregator, or V2G services. In aggregation at larger scale EVs can participate in the energy flexibility markets (e.g., National Grid's Short Term Operating Reserve). A number of aggregators approved by National Grid are on the market offering such services (e.g., Kiwi Power, Origami Energy Limited, Open Energy, Limejump, EDF Energy, Energy Pool / Schneider Electric).

2.4 EV demand status

Along with the charging network, the number of EVs on UK roads has also been steadily increasing. The profile of EV stock since 2010 along with the annual market share in sales, considering BEV and PHEV are given in

Figure 2.7. Starting from 2013, the annual sales of PHEV were higher than BEV, leading to the higher stock of PHEV in the UK. Since 2018, the sale of PHEV has declined, however, annual sale of BEVs has experienced a steep increase, which may be attributed to the Tesla Model 3 (launched in 2017) which has the highest number of units sold in the UK as shown in Figure 2.8.

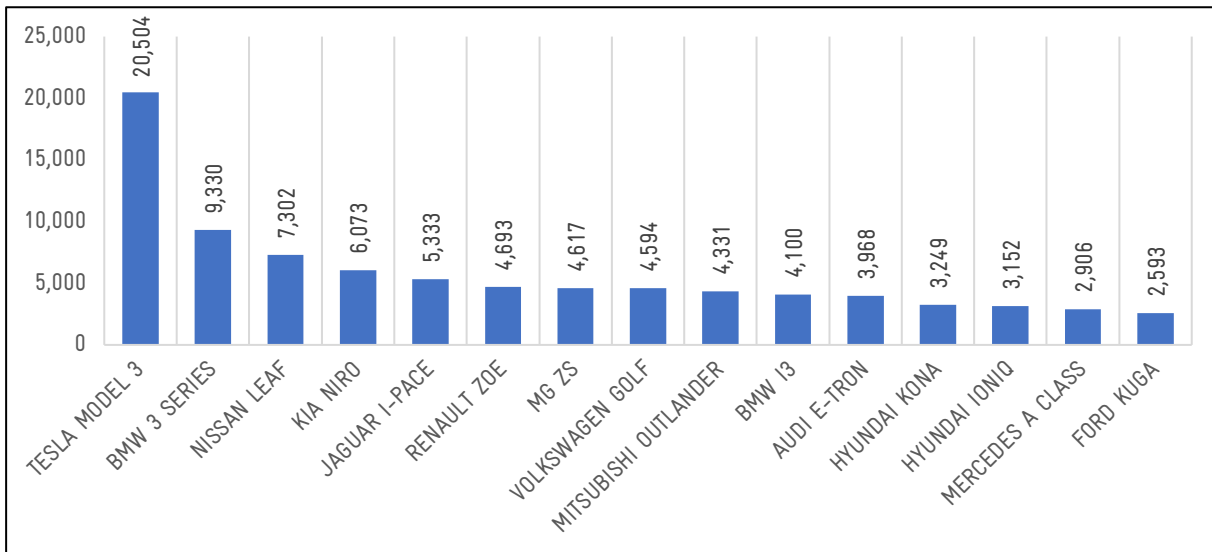

Figure 2.8: Top 15 BEV/PHEV models from October 2019 to September 2020 (Vehicles Statistics, 2020)

As per the reports from New AutoMotive, a UK-based independent transport research organisation aiming to support and acceleration the EV revolution, the new registrations in EV segment showed strong growth in the country, with battery EVs now positioned third behind conventional fuel-powered and hybrid vehicles in terms of new sales (Lewis, 2021). Around 16,000 new battery EVs were registered during June 2021, which is a record setter until now in 2021. On the contrary, the sale of diesel-powered cars has been plummeting ever since the pandemic began with no sign of resurgence. The Northeast and Southeast regions and London have been reported to be the hotspots for new EV registrations.

To increase the uptake of EVs the Government offers the Plug-in Grant program, an incentive launched in 2011, which provided a 25% grant towards the cost of new plug-in cars, and the Plug-in Van Grant which provided a cost rebate of 20% (up to INR 8.19 lakh (EUR 9310)) of the cost of the plug-in van. (*Low-Emission Vehicles Eligible for a Plug-in Grant - GOV.UK*, n.d.)

At the same time developing the second-hand market for EVs is important for increasing accessibility, making EVs more affordable to consumers. According to Energy Saving Trust

forecast the expected number of EVs could be between 15.6 million and 19.4 million electric cars in the UK by 2035 (for the baseline the total number of cars in the UK was 32 million in 2019).

Table 2.2: Forecast for the uptake of EV in UK assuming an average car life-span of 15 years and stable registration of 2.2m cars per year (Energy Saving trust, 2020)

Year	Electric cars as a percentage of new car sales		Total number of electric cars in the UK (cumulative)		Electric cars as a proportion of all cars	
	Lower uptake scenario	Higher uptake scenario	Lower uptake scenario	Higher uptake scenario	Lower uptake scenario	Higher uptake scenario
2010	0%	0%	252		0%	0%
2015	1%	1%	50,234		0%	0%
2020	5%	10%	376,99	486,999	1%	1%
2025	28%	40%	2,411,747	3,566,747	7%	11%
2030	50%	70%	6,893,655	9,918,655	21%	30%
2035	100%	100%	15,611,999	19,406,999	47%	59%

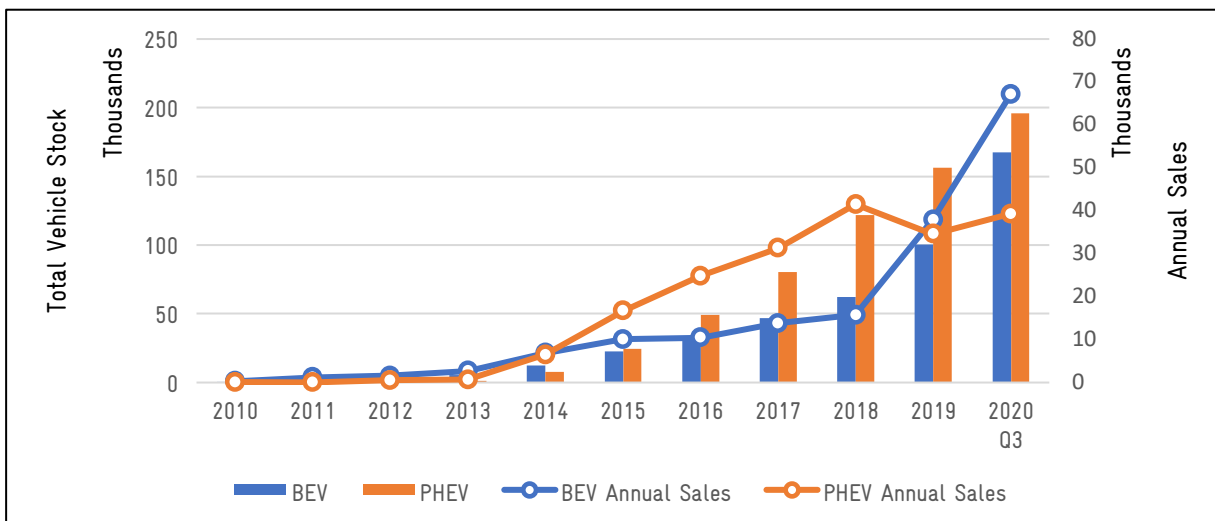

Figure 2.7: BEV/PHEV market statistics in UK (Vehicles Statistics, 2020)

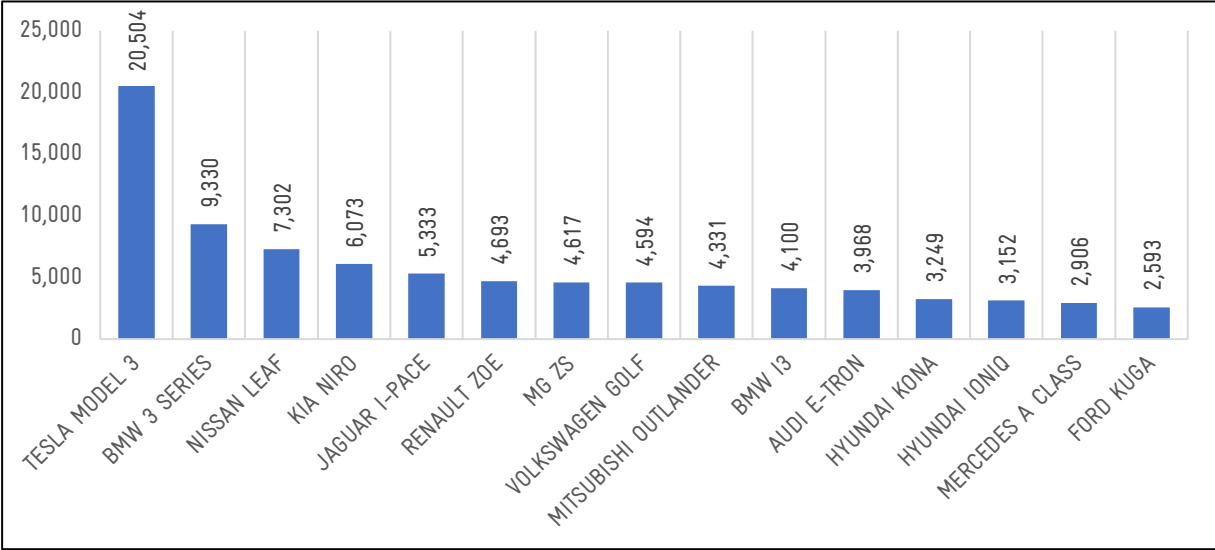

Figure 2.8: Top 15 BEV/PHEV models from October 2019 to September 2020 (*Vehicles Statistics, 2020*)

As per the reports from New AutoMotive, a UK-based independent transport research organisation aiming to support and acceleration the EV revolution, the new registrations in EV segment showed strong growth in the country, with battery EVs now positioned third behind conventional fuel-powered and hybrid vehicles in terms of new sales (Lewis, 2021). Around 16,000 new battery EVs were registered during June 2021, which is a record setter until now in 2021. On the contrary, the sale of diesel-powered cars has been plummeting ever since the pandemic began with no sign of resurgence. The Northeast and Southeast regions and London have been reported to be the hotspots for new EV registrations.

2.5 EV integration

The rapid growth of EV is expected to stress the power system (Calvillo & Turner, 2020), and therefore, due consideration to system constraints need to be given while planning EV charging infrastructure. Western Power Distribution’s (WPD) network of LV transformers for supplying power to the local networks are sized to accommodate the traditional demands of the area they serve (*Electric Vehicle Strategy, 2020*). The WPD has reduced the range of ground-mounted and pole mounted transformers since 2013, which implies that these transformers have some available capacity for future growth. This capacity is utilized by WPD to accommodate EV chargers. This available capacity is higher for urban areas which have a dense spread of transformers as compared to rural areas. WPD estimates that the majority of the larger local

transformers will be able to accommodate a 35 kWh charge every 5 days, for each customer connected to it. With these considerations, WPD has released an interactive map, shown in Figure 2.9, which shows where their existing distribution substations can offer capacity for EV charging and which of them are limited by constraints (*EV Capacity Map Application*, 2019).

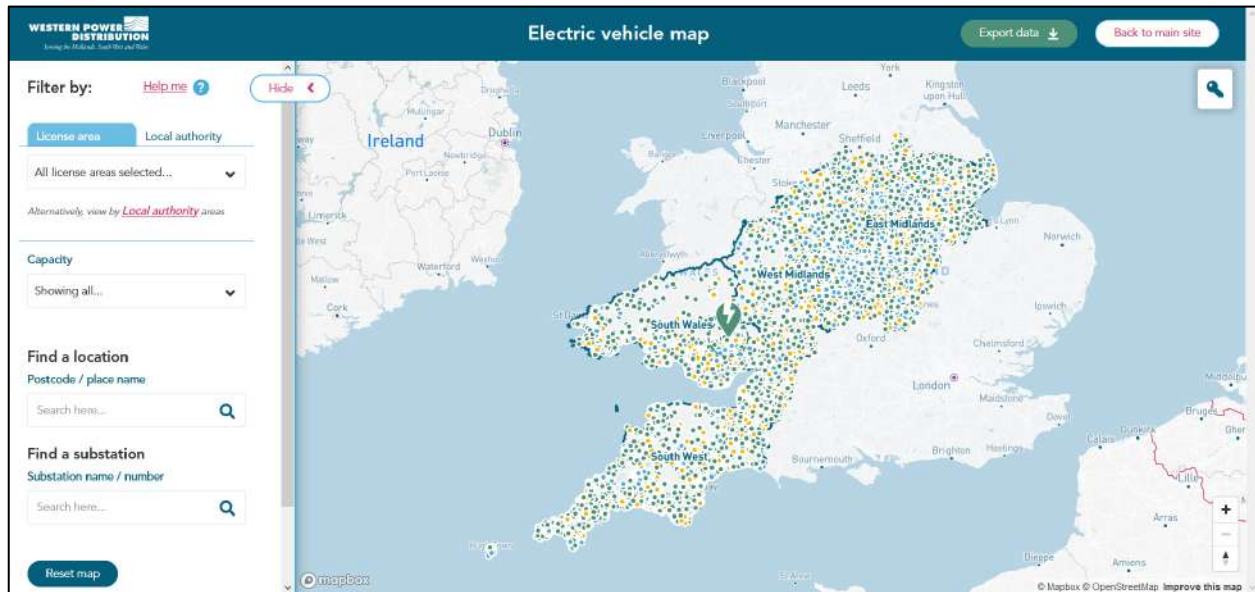

Figure 2.9: Interactive map released by WPD showing the capacity available in each distribution substation for placement of EV chargers (*EV Capacity Map Application*, 2019)

Locations where EV is charged, and the time of charging is also crucial in determining the grid impacts of EV charging. Majority of the private EVs charge at home (87%) as shown in **Figure 2.11** (Ofgem, 2018), in comparison to 8% charging at their workplaces, 4% charging at destinations like malls and other public spaces, and only 1% charge en route. Except for home charging and charging at the workplace, EVs charging in public spaces will remain connected for a shorter duration of time. This has been reflected in Figure 2.10 (Ofgem, 2018) which shows that charging time in a public rapid charger typically lasts from 30 mins to an hour.

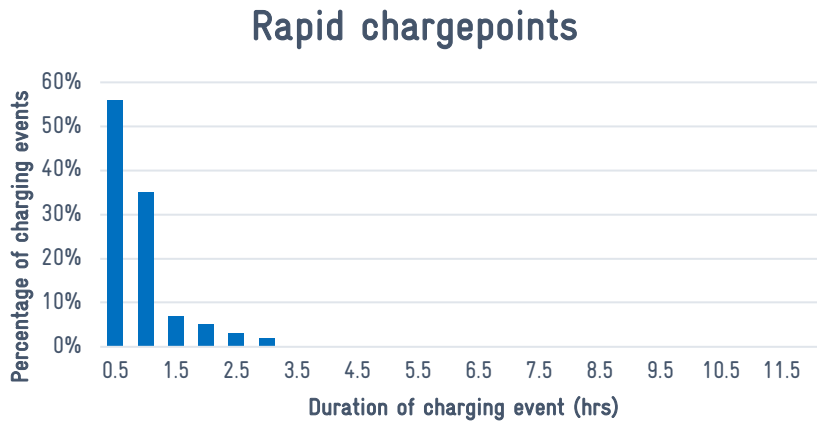

Figure 2.10: Duration of charging at public rapid charge points (Source: Ofgem)

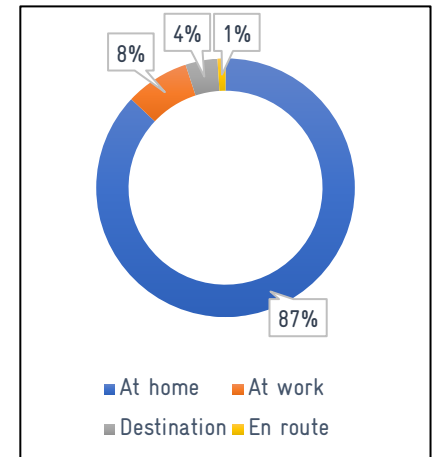

Figure 2.11: Pie chart showing where EV users currently charge their vehicles (Source: Ofgem)

An EV charging survey, conducted in November 2020, that explored three key areas: Charging at home, charging at the workplace and the use of the public network for charging has provided some interesting results. Based on the survey, with 2201 respondents, 83% of them had access to EV charging at home and 78% of those chargers had a power rating of 7kW, while 13% had slow chargers with a power rating of 3kW. In regard to the availability of charging at the workplace, only 16% of the respondents had access and 49% of the office chargers were also rated at 7kW. 18% of office chargers were fast chargers with a rated power of 22kW, while there was no fast DC charging availability. Again, 90% of the respondents use public charging networks, and the most common chargers used in public charging were single-phase 7kW AC charging and rapid DC charging (25-50kW) (Zap-Map, 2020).

2.5.1 Installation of Charging points

The procedure for installation of charging points in the Northern PowerGrid and the associated costs is provided in this section.

Home and Residential Charging

To install an EV charger at home, the EV user needs to consult one of the charge point installers⁴ who makes an assessment of the property to determine it has the available power capacity to accommodate an EV charging load. The installer will also check the premises and if there is a power source close to vehicle parking space. This information is then sent to the grid operator who cross checks if the distribution network can accommodate the increase in demand. In cases where there needs to be a upgrade to the connection to the property the relevant charges as mentioned in

Table 2.3 Table 2.3 may be levied (*Your Guide to Electric Vehicle Charging*, 2019).

Destination and commercial charging

Similar to the installation of chargers at residences, for destination and commercial locations too an installer needs to be consulted, who will assess the existing electrical demand on the premises and whether the extra EV load can be accommodated in the existing system. If the increase in demand is more than the contracted power limit, then the installer will contact the grid operator for an increase in the size of the connection.

The indicative costs for installation of chargers for different customer types have been summarized in

Table 2.3

Table 2.3: Typical cost for a new connection

Typical for	Street lighting	Domestic property Single phase	Small commercial property, three phase connections	Medium commercial, e.g., Motorway services, future petrol stations	Industrial, e.g., Factories, future motorway services
Capacity sought	<1.4 kW	<18 kW	<55 kW	< 276kW (fuse) or <1.1 MW (air CB)	< 8MW
Typical Charger power rating	<1.4 kW	Up to 7 kW	Up to 43 kW	120-350 kW	350 kW

⁴ The exhaustive list of charge point installers can be found at

https://assets.publishing.service.gov.uk/government/uploads/system/uploads/attachment_data/file/974134/electric-vehicle-homecharge-scheme-authorized-installers-29-march-2021.csv/preview

Average price (INR/EUR)	61,641 – 308,205/ 700 – 3500	61,641 – 154,102/ 700 – 1750	11,30,087/ 12830	11,30,087– 97,59,844/ 12,830 – 110,806	97,59,844+/ 110,806
--------------------------------	------------------------------------	------------------------------------	---------------------	--	------------------------

2.5.2 Standards and Regulations for EV integration in the UK

The Standards and regulations required for V2G in the UK and EU are mentioned below (MacLeon & Cox, 2018). These standards which are also applicable for V1G. International standards and communication protocols are described in detail in Chapter 3 and Chapter 4 of Report 1 - Fundamentals of Electric Vehicle Charging Technology and its Grid Integration.

Charge Point to Vehicle Interface

- ISO 15118
 - It is an international standard defining V2G communication for bi-directional charging/discharging of EVs and is concerned with the communication between the EV and the EVSE.

Charge Point to Network Interface

- OSCP 1.0
- Distribution Network Interface
 - For an electricity network operator, an EV exporting power can be considered as a generator connected in parallel to the network and accordingly it has to meet a set of technical requirements.
 - In the UK, all distribution network operators are required to comply with the GB Distribution Code, which is maintained by the Distribution Code Review Panel and approved by Ofgem
 - From 17th May 2019, Engineering Recommendation (EREC) G98 and EREC G99 will be applicable for all new installations, effectively replacing EREC G83 and EREC G59, Figure 2.12
 - EREC G59 underlines the connection procedure for connecting micro-generation to LV network, where the aggregated power is less than 50 KW or 17 kW per phase.
 - EREC G98/1 updates the connection requirements of fully type tested micro-generators (up to an including 16 A per phase) to the LV network. It

also covers the connection procedures of multiple micro-generators in a close geographical location.

- EREC G99/1 covers the connection of generating units having an extended range than micro-generators. The generating units defined here as ‘Power Generating Modules’ are defined as given in

- Table 2.4.

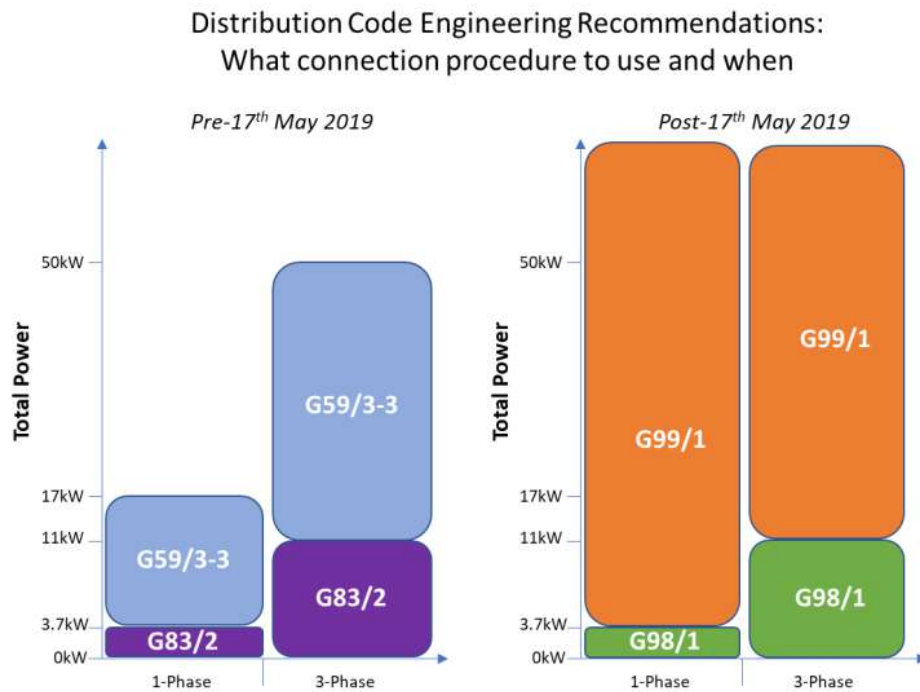

Figure 2.12: Distribution network connection procedures

Table 2.4: Ratings of Power Generation Modules

	Type A	Type B	Type C	Type D ₁	Type D ₂
Connection point	Below 110 kV	Below 110 kV	Below 110 kV	Below 110 kV	110 kV +
Registered Capacity	0.8 kW – 1 MW	1 MW – 10 MW	10 MW – 50 MW	50 MW+	Any

Charge Point to Operator Interface

- Open Charge Point Protocol (OCPP) 2.0
 - OCPP is a universal open communication standard between the vehicle, the charge points, and the charge point network operator.
- Open Charge Point Interface (OCPI) 2.11
 - OCPP 2.11 describes in detail the methods for implementation of fully scalable system for availing roaming services, with focus on communication between charge point operators and the e-mobility service companies.

2.5.3 Smart Charging

The UK has also laid out the policies and the expected rollout of smart charging in a phased manner (*Electric Vehicle Smart Charging*, 2019). In this regard, the British Standards Institute has released a draft code of practice for energy smart appliances and demand side response in 2020. The purpose of this publicly available specification (PAS) was to standardize the control of energy smart appliances which also is applicable to smart charging of EV (*PUBLICLY AVAILABLE SPECIFICATION PAS 1879: 2021 , Energy Smart Appliances – Demand Side Response Operation – Code of Practice*, 2020). Even if a consumer decides to implement the smart charging functionality, they reserve the control to override the smart charging based on their requirement.

As per the BSI standard, two different architectures were laid out for the customer participation in the smart energy usage. Either the customer can have a residential smart energy manager that attempts to efficiently manage the customers own daily energy requirements as shown in Figure 2.13 or through a cloud-based customer energy manager that manages multiple different energy smart appliance as shown in Figure 2.14. The different stakeholders engaged in this framework are listed under

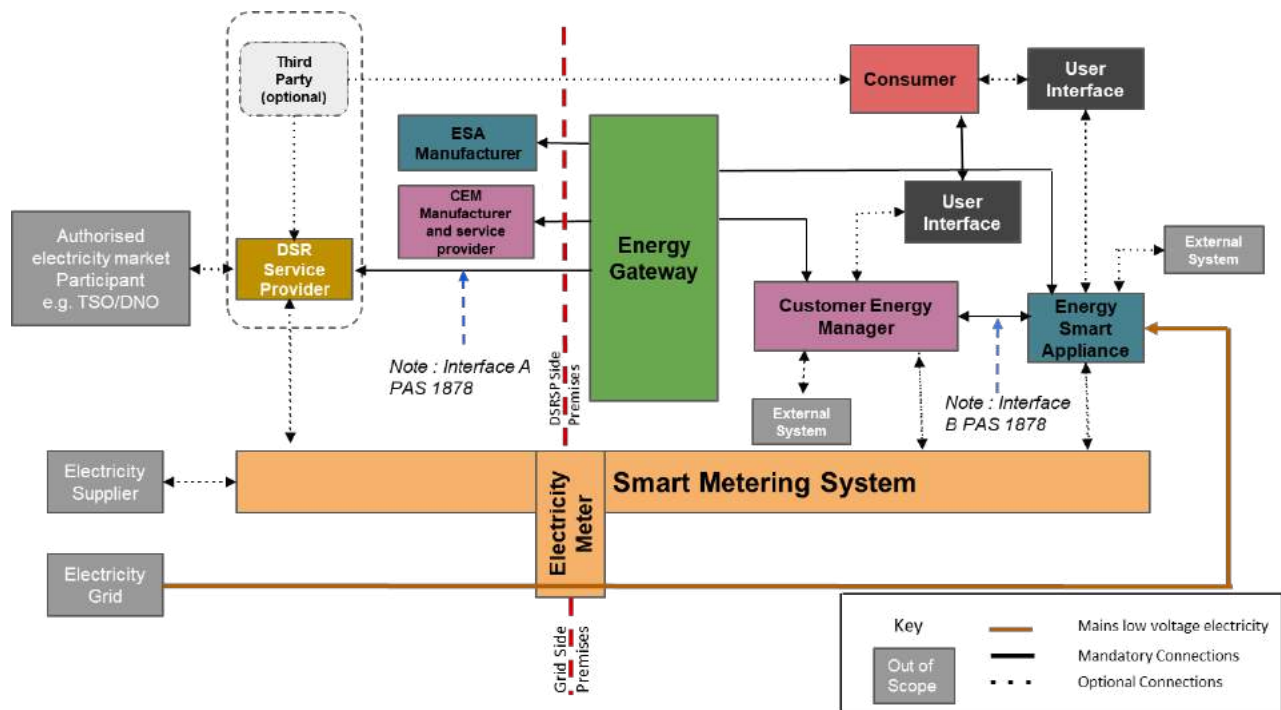

Figure 2.13: Demand Response Architecture in residences (*PUBLICLY AVAILABLE SPECIFICATION PAS 1879 : 2021 , Energy Smart Appliances – Demand Side Response Operation – Code of Practice, 2020*)

- **Demand side response service provider (DSRSP):** It is an organization that links the TSO/DSO or other authorized energy market participants to the energy smart appliance (ESA) to provide demand side response (DSR) related energy management.
- **Energy Gateway:** It is the communication bridge between the DSR providing appliances located inside the premises and the DSRSP in case of residential DR and the customer energy manager in case of centralized control.

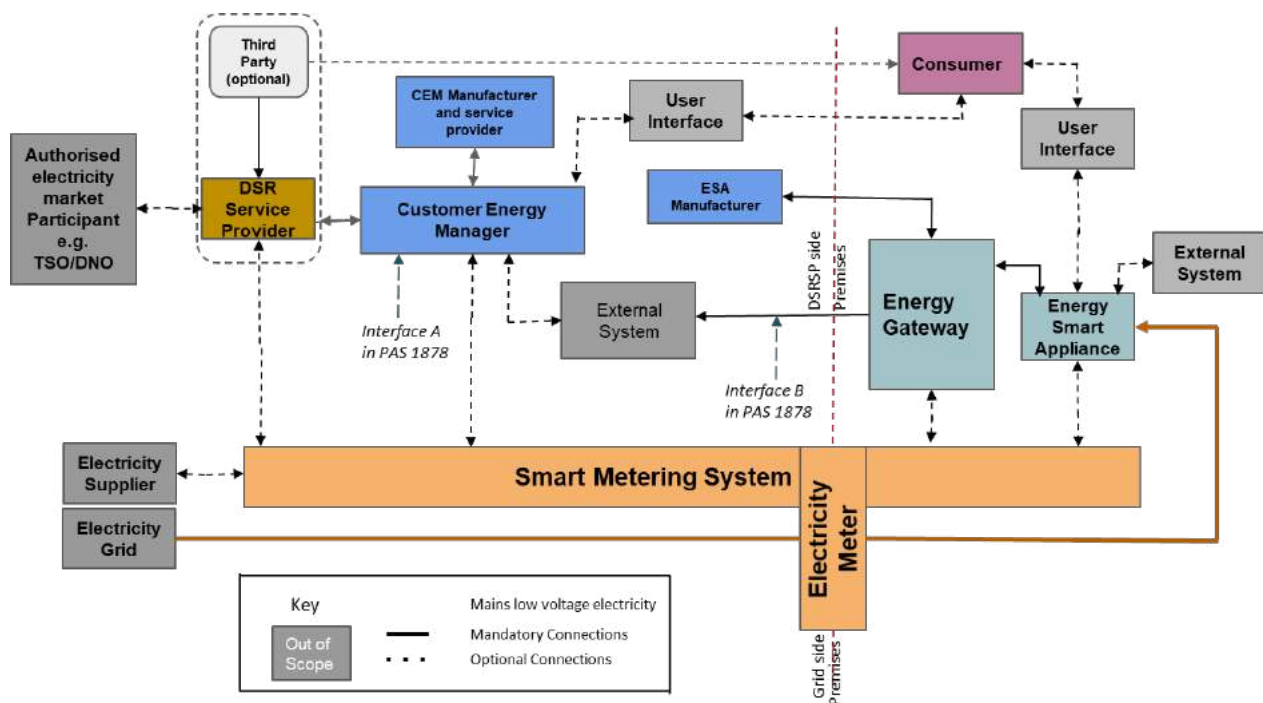

Figure 2.14: Demand Response architecture for cloud based Customer Energy Manager (*PUBLICLY AVAILABLE SPECIFICATION PAS 1879: 2021 , Energy Smart Appliances – Demand Side Response Operation – Code of Practice, 2020*)

- **Customer Energy Manager (CEM):** This is an entity that gives logical signals for management of the ESA or the energy gateway in case of multiple ESA.
- **Energy Smart Appliance (ESA):** It is any appliance which can respond to communication signals alter its power signature accordingly.

The DSRSP and the CER shall be interlinked using the Interface A, and the interface should be interoperable between the DSRSP and any CEM and vice versa. It will exchange information related to device registration, deregistration, flexibility offers, DSR events, status and cyber-security breaches (*PAS 1878: 2021 , Energy Smart Appliances – Classification – Specification, 2020*).

The CEM and the ESA communicate using Interface B, which shall be defined by the CEM or ESA manufacturer, however, there should be a clear correspondence between the information model and message sequencing used by both Interface A and Interface B.

Moreover, regardless of the underlying communication protocol, an external CEM managing several ESA will use the set of Internet Protocol (IP) for connection, cyber-security, and data transport. In case of internal CEM, it is likely that IP protocol with communication through ethernet will be used more over Wi-Fi, power line or twisted pair of cables.

Interface A too will use secure internet protocols and shall support Public Key Infrastructure (PKI). A non-IP based communication protocol such as Zigbee 1.x will not be used for Interface A by the CEM.

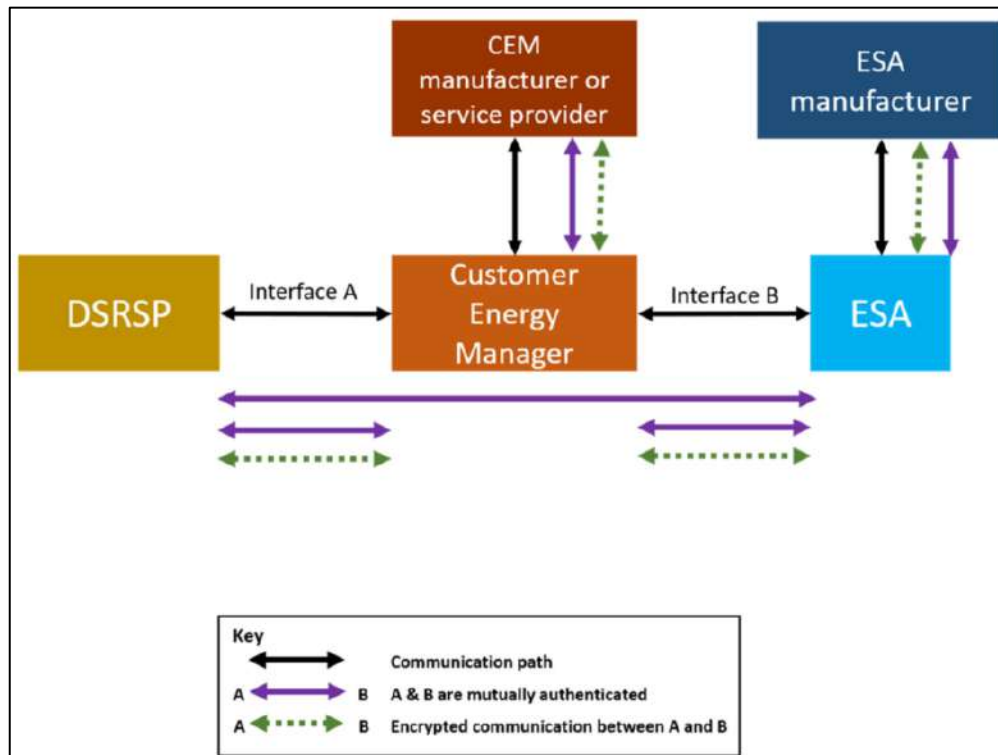

Figure 2.15: Encryption and communication of information between the DSRSP, CEM, ESA (PAS 1878: 2021 , Energy Smart Appliances – Classification – Specification, 2020)

Operating Modes

The different operating modes of ESA management and their priorities have been discussed in this section. During normal operation, the CEM shall update the DSRSP of the flexibility offers at appropriate event points.

2.5.3.1.1 Mode 1: Routine Mode

The CEM here will manage the ESA according to the consumer preferences. This is the normal mode where the ESA will operate when everything is ideal in the network.

2.5.3.1.2 Mode 2: Response Mode

The CEM shall enter Mode 2 when it receives a valid DSR signal from the DSRSP which also includes a static or dynamic frequency response request (*Static and dynamic signals will be provided to only those CEM/ESA communication which are capable of meeting the technical constraints set by the DSRSP*). The CEM shall remain in this mode until

- The period stated by the DSRSP request ends

- The DSRSP requests the period to end
- The consumer overrides the DSR operation
- The failsafe protection occurs.

2.5.3.1.3 Mode 3: Consumer Override

The CEM operates in Mode 3, whenever it receives a manual override from the user.

2.5.3.1.4 Mode 4: ESA Failsafe

The ESA should have an inbuilt logic, that ensures that the ESA does not operate beyond its rated capacity or in a manner that is harmful or hazardous, by going into a failsafe state. The ESA shall notify the CEM, when the ESA goes into this mode.

The priority of the different modes is given in Table 2.5.

Table 2.5: Priority of operating modes

Operating Mode	Priority
ESA failsafe	1 st
Consumer override	2 nd
Response mode	3 rd
Routine Mode	4 th

Information communicated between the different entities

The flow of information across the interfaces are categorized into the following phases:

- Customer registration with DSRSP
- CEM and ESA mutual authentication
- Registration of the CEM and the ESA with the DSRSP
- Initialization
- Normal operation
- Exception conditions
- De-registration

2.5.3.1.5 CEM and ESA mutual Authentication

Table 2.6: Information passed from ESA to CEM during authentication

Information Element	Mandatory(M)/ Optional(O)	Note
ESA manufacturer name	M	
ESA unique serial number	M	
ESA EUI-64	M	This element shall provide the extended Unique Identifier of the ESA that is an 8-byte (64 bit) value
ESA firmware version	M	
ESA firmware update date	M	

Table 2.7: Information passed from the CEM to the ESA during authentication

Information Element	Mandatory(M)/ Optional(O)	Note
Identification token	M	Sent from the local CEM to the ESA as a part of the authentication verification process. For external CEM this shall be passed to the customer.

2.5.3.1.6 Registration of CEM and ESA with the DSRSP Table

2.8: Information passed from CEM to DSRSP during authentication

Information Element	Mandatory(M)/ Optional(O)	Note
CEM manufacturer name	M	
CEM unique serial number	M	
CEM EUI-64	M	This element shall provide the extended Unique Identifier of the CEM that is an 8 byte (64 bit) value
CEM firmware version	M	
CEM firmware update date	M	
ESA manufacturer name	M	
ESA unique serial number	M	

ESA EUI-64	M	This element shall provide the extended Unique Identifier of the ESA that is an 8 byte (64 bit) value
ESA firmware version	M	
ESA firmware update date	M	

Table 2.9: Information passed from DSRSP to CEM during authentication

Information Element	Mandatory(M)/ Optional(O)	Note
Identification token	M	

2.5.3.1.7 Initialization

Table 2.10: Information sent from the ESA to the DSRSP via the CEM

Information Element	Mandatory(M)/ Optional(O)	Note
Flexibility offer types	M	Which flexibility offer type the ESA is capable of providing during normal operation and shall consist of at least one of the following <ul style="list-style-type: none"> • Forecast power profiles • Curtailment power values over a given periods • Frequency response services
Power reporting type	M	Inform the DSRSP which power reporting type is available. At least on the following <ul style="list-style-type: none"> • Instantaneous power consumption/production sent to the DSRSP with a given periodicity • Power consumption or production profile sent to the DSRSP following the end of the DSR event
ESA type	O	Whether the ESA is an electric HVAC/ smart EV charge point/ battery storage etc.
ESA classification	O	Max/min consumption and/or production

Table 2.11: Information sent form DSRSP to ESA via CEM

Information Element	Mandatory(M)/ Optional(O)	Note
Preferred power reporting type	M	Provided only if the ESA presents a choice to the DSRSP

2.5.3.1.8 Normal Operation

Table 2.12: Information passed from ESA to the DSRSP via the CEM during Normal operation

Information Element	Mandatory(M)/ Optional(O)	Note
Flexibility offers	M	The ESA shall inform the DSRSP about its current flexibility offerings and shall include the following <ul style="list-style-type: none"> • Forecast power profiles • Frequency response service
Actual power profile	M	If the ESA is able to provide, or if the corresponding reporting type have been chosen by the DSRSP
Actual instantaneous power value	M	If the ESA is able to provide, or if the corresponding reporting type have been chosen by the DSRSP
Acknowledgements	M	The ESA shall indicate its implementation of one its flexibility offerings as chosen by the DSRSP by sending an acknowledgement to the DSRSP
DSR event cancelled	M	The "DSR event cancelled" information element shall be used by the ESA to indicate to the DSRSP that it is no longer implementing the previously selected flexibility offer
Free text	O	

Table 2.13: Information passed from the DSRSP to the ESA during normal operation

Information Element	Mandatory(M)/ Optional(O)	Note
Flexibility offer request	M	Information sent by DSRSP to the ESA to request which flexibility offer is being requested
DSR event cancelled	M	Includes cancelled flexibility offer identifier
Tariff	O	

2.5.4 EV Aggregators

UK has several aggregators with smart charging capabilities listed below.

- GridServe provides users with solutions for the purchase/lease of EVs and it also has a network of EV chargers (*Ev Power - Overview*, n.d.).
- Octopus group provides EV charging solutions. It has an ongoing V2G implementation program called Powerloop. A person willing to participate in this program is leased a

Nissan LEAF, a bidirectional charger, and willingness to plug-in their vehicle before 6 pm and stay connected until at least 5 am the next day to complete one cycle. Completing 12 cycles for a month provides cashback benefits to the user (*Powerloop-V2G*, n.d.).

- Octopus Go tariff structure has lower tariffs between 12:30 am and 4:30 am to incentivize the charging when the grid is lightly loaded (*Octopus Go*, n.d.).
- Octopus Agile tariff provides half-hourly pricing which reflects the cheaper wholesale energy prices and designed according to the mobility requirements of the (Octopus Energy, n.d.).

2.6 Case studies

2.6.1 My Electric Avenue

Project Category: Demonstration Project

Project Aim: Determine whether a third party can accelerate the deployment of innovation on the DNO networks and the extent to which a Distribution Network Operator (DNO) direct control can facilitate the connection of low carbon technology (*My Electric Avenue - Project Close-Down Report*, 2016).

Project Duration: 2013-2016

Project Stakeholders: EA Technology led the project, and Scottish and Southern Electric Power Distribution (SSEPD) (the host Distribution Network Operator) with project partners, namely Northern Powergrid (collaborating DNO), Nissan (EV supplier), Fleetdrive Electric (EV rental program management) and Zero Carbon Futures (charging point network developer), alongside academic partners, namely, The University of Manchester (providing network modelling and analysis), and De Montfort University (providing socioeconomic data gathering and analysis).

Summary: My Electric Avenue studied the impact of EV penetration on local electricity networks. Over 100 people, in different clusters around Britain were recruited to My Electric Avenue's technical trials. Each cluster has up to 12 Nissan LEAFs on the same LV feeder, which enabled sets of data relating to when and how EVs were charged and also its impact on the LV network. It has been concluded that increasing EV penetration causes both thermal capacity overloading and voltage variations in the LV network. Around 32% of the UK LV feeders will require intervention to protect against thermal overloading or voltage violations at EV penetration levels exceeding 40%. A smart charging prototype called ESPIRIT, which dynamically prevents EV charging during periods of high network load was implemented under this case study.

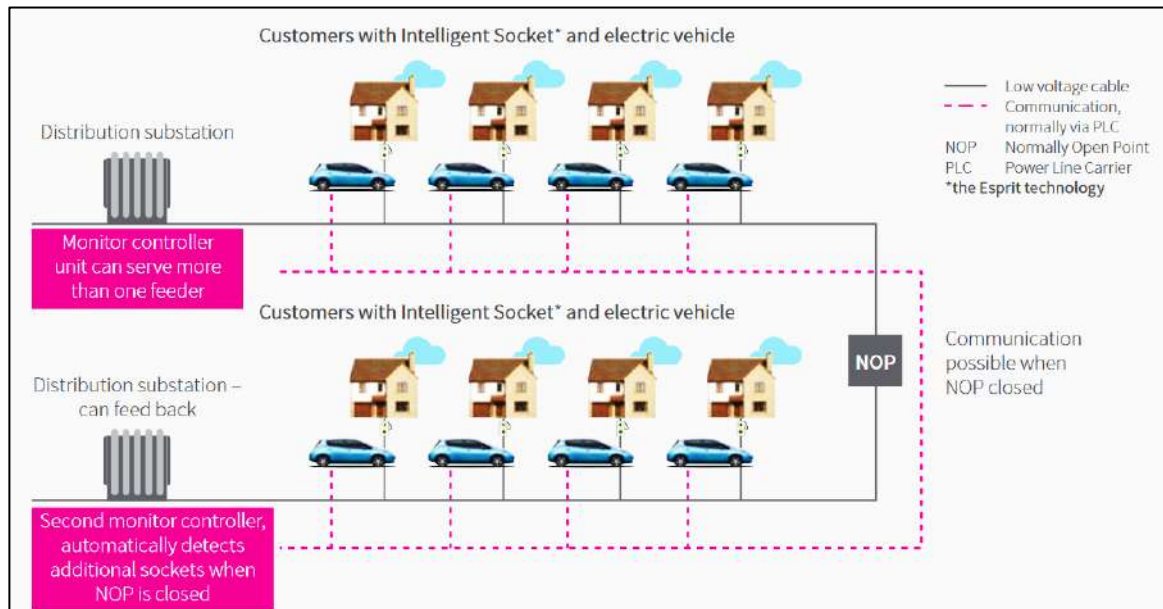

Figure 2.16: Overview of Espirit Technology (*My Electric Avenue - Project Close-Down Report, 2016*)

The charging points installed for the trial participants were all connected to the Espirit Technology. The Espirit technology included two components, the **Monitor Controller (MC)** and the **Intelligent Control Box (ICB)**. The overview of Espirit is given in Figure 2.16

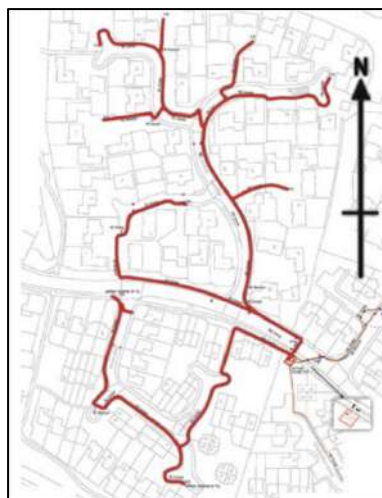

Figure 2.17: Chineham Cluster (*My Electric Avenue - Project Close-Down Report, 2016*)

The Monitor Controller monitors the LV feeder phase currents, and it issues switching commands to each ICB, to protect the network from overloading. The MCs are located within an 11kV/400V substation, with one MC for each cluster. An example of a cluster is given in Figure 2.17. The communication between the MC and the ICB is achieved through Power Line Communication (PLC). The PLC injection points enabled PLC signals are to be sent both to and from the ICB using the LV feeder.

The role of the ICB was to act on the commands from the MC and also report back information on the charging history of the EV to the MC. Each ICB was located between the consumer unit and the Charge Point within the participant's premises.

The network impacts due to high EV penetration with and without Esprit are shown in Figure 2.18. In winter season, even with EV penetration little over than 30%, unconstrained charging exceeded the feeder capacity, while in summers the feeder was able to accommodate up to 50% EV penetration. Comparatively, using Esprit technology, even with penetration higher than 100% the current in the feeder never exceeded its rated limits.



Figure 2.18: Unconstrained and Esprit enabled network impacts with increasing EV penetration levels, (x-axis: EV penetration (in %), y-axis: thermal capacity utilized (in %))(My Electric Avenue - Project Close-Down Report, 2016)

Learnings:

- The residential EV charging coincides with the traditional evening peak.
- Increasing penetration of EVs on LV feeders result in both thermal and voltage issues.
- Thermal congestion occurs at lower EV penetration levels compared to voltage problems.
- Using simple switching of EV, the thermal capacities of the feeder can be maintained for high penetration of EVs.
- The participants also readily accepted EVs as their means of commute with an acceptance score of between 3.7 and 4.2 (1 indicates the participant is completely unfavourable of EVs and 5 indicates maximum favourability)
- The cycle time of an Esprit type system is critical to the DSR efficacy, power quality on the distribution network, and the longevity of the EV battery. Dialogue with EV and charge

point manufacturers indicated that a minimum cycle time of six minutes would be sufficient to protect the EV battery. In addition, no more than five 3.5 kW charge points can be switched at one time without causing power quality problems on the distribution networks studied. The recommended cycle times for any such DSR technology are a 'minimum-off-time' of 15 minutes and a 'maximum-off-time' of 60 minutes. So, utilizing DSR would result in reduction of charging time which may increase TCO of vehicles used for commercial purpose.

2.6.2 LV Connect and Manage

Project Category: Pilot Project (*LV Connect and Manage Closedown Report, 2019*)

Project Aim:

- Use of Active Network Management (ANM) solutions to control low carbon technologies (LCTs) in real-time considering operational limits.
- Demonstration of ANM solution as a short or long-term alternative to network reinforcement, due to localized uptake of LCTs.

Project Duration: 2016-2019

Summary: As network reinforcement for the accommodation of increased LCT technologies such as EV and distributed renewable generation can be an economic burden, so this project demonstrates technology for low voltage active network management which extends communications and controls beyond customer's meters and can deal with bi-directional power flows. The architecture utilized for ANM in LV Connect and Manage is given in Fig. 41. Here, **iHost** is a software platform, located in a secure data center where the centralized algorithm is hosted and monitors the downstream components. It provides a graphical user interface and reporting features to the Western Power Distribution and other system users to monitor the system performance. The **Broadband-over-Powerline (BPL)** Network Management System (NMS) is co-located with the iHost in the data center. Using VPN, the NMS is accessed. BPL is a physical communication channel and there needs to be a modem for each communicating device. The **Distribution Substation Monitoring** is placed at the LV side of the substation, and it includes power and voltage measurement device, an envoy unit that monitors the power flows and voltages, a 3G/4G router which provides communication between substation and iHost, and the BPL modem for communication between the substation and LV homes. The **Domestic Load Control (DLC) for EV and PV customers** also has an Envoy connected to the EV charge

point/PV inverter system for set point controls and BPL system for communications. In case of failure of BPL communications, the DLC are also provided with a SIM card for mobile communications.

Figure 2.19, shows the ANM system in operation. When the active power measured at the substation exceeds the transformer capacity, the system relays the information to the individual EVs to reduce their charging power, thus decreasing the extra burden from the transformer.

One of the goals of the project was to estimate the effectiveness of BPL for ANM. Unfortunately, the project concluded that BPL was not fit for the purpose of the LV Connect and Manage application as the system was susceptible to electrical noise and attenuation in the LV network. There was not sufficient confidence that control signals could be transmitted through BPL during peak times of electrical loading.

The architecture described above, encompassing all components, was deployed in the first phase of the project within WPD's Hereford Depot to trial solution in a real-life environment.

Testbed Architecture: The testbed architecture account for the following features: (i) a decentralized ANM system within the LV substation (to monitor grid operational parameters, specifically local voltage and power flow, and determine optimal control signals based on the local constraints); (ii) a 7 kWh battery/inverter system interfaced with the on-site 50kW PV array along with a DLC unit for controllability and observability of the PV array generation ; and (iii) a 7.4kW (32A) single-phase EV charge point interfaced with a DLC box configured for import limiting.

Substation Installations (DNO-Side): The design of the decentralized ANM controller constituted a magnetic mounting foot to allow its installation on the side of metallic infrastructure within the substation.

This feature allowed its easy relocation to other substations (if the need arises). Also, it did not require drilling holes through the fabric of the LV cabinet (prohibited within WPD's policies since it affects the integrity of the cabinet and might lead to the risk of moisture ingress).

LCT Installations (Customer-Side): The customer-side solution architecture was deployed as a battery energy storage system (BESS) with a DLC interfaced with the battery inverter along with a controllable EV charge point interfaced directly with the DLC.

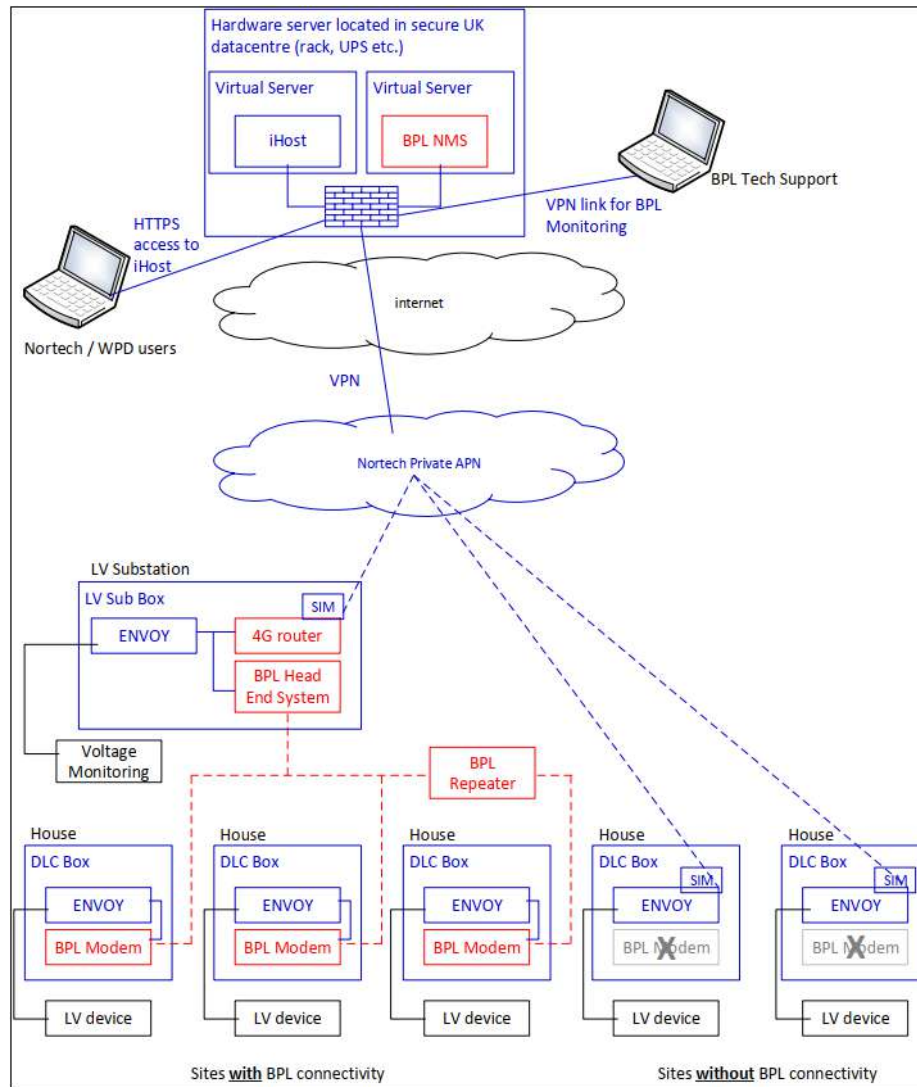

Figure 2.19: The LV Connect and Manage solution architecture (*LV Connect and Manage Closedown Report, 2019*)

Technical Tests: The technical architecture and equipment used in the trial allowed the following tests,

- Demonstrating the feasibility in controlling the EC charging current in the range on 0 – 32 A using BPL and GSM;
- Demonstrating the feasibility of controlling the PV/BESS discharge current via BPL and GSM communication channels;
- Demonstrating the auto-failover of communications from BPL to GSM and vice-versa; and
- Demonstration of the operational principles for managing the import and export limitation system in order to protect the robustness of the distribution feeder.

An example of an EV charge point and DLC equipment installation is portrayed in Figure 2.20. The DLC box is co-located with the LCT to minimize the length of cable for communication between the DLC unit and the LCT. Each DLC box also had a miniature external antenna to maximize signal strength for cellular communications. Contactor switches were used to trip the LCT in the event of loss-of-power (and hence communications and controllability) to the DLC box.



Figure 2.20: Typical example of the EV charge point and DLC installation in customers' homes (*LV Connect and Manage Closedown Report, 2019*)

All the set aims, and objectives were met by LV Connect and Manage.

- The architecture was successfully developed for the LV Connect and Manage solution, which incorporated communications and control components in order to control the LCT units based on real-time grid conditions.
- Monitoring, aggregation, and continuous comparison of the LCT power import and export were done under operational limits for both EV and BESS
- An active network management system developed to connect and manage LV LCTs.
- The effectiveness of broadband over-powerline was demonstrated for the bi-directional power flow control of LCTs. However, the conclusion was made that this communications medium was not suitable for the LV Connect and Manage solution.
- The control of LCT units based on the network constraints have been successfully demonstrated.
- The use of such control have been demonstrated to avoid/postpone the need of grid upgradation.

- Novel business models have also been formulated for integration of DLC control units with the customer LCT units along with policy recommendations.

During the project duration, three modifications were made to the planned approach.

Limitation of the deployment of BPL infrastructure and procurement of additional SIM cards (a result of BPL limitations): Originally, the project aimed for trialling the effectiveness of BPL at six substation sites. However, early results showed that BPL was not suitable for communication requirements in the LV Connect and Manage trial. BPL systems have been found to be sensitive to the electrical noise and attenuation in the LV network. Also, there were difficulties faced in propagating the signals to the consumer unit, i.e. it had limited range, which increased the requirement of number of repeater units for coverage of the entire trial area. Also, during peak load periods, the capability of sending control signals over BPL was doubtful.

Therefore, further deployment of BPL infrastructure was ceased to restrict the expenses for this particular aspect of the project and added SIM cards were acquired to extend communications and controls to the entire fleet of DLC boxes.

Pairing DLC boxes and LCTs in the factory and testing communications and controls prior to installation in customers' homes: The LCTs (EV charge points and battery inverters) needed software configuration to permit the ANM system the required communication and controllability features. As, most contractors do not have the necessary skillset, the LCTs and the DLC units were assembled inhouse.

Adapting to changes in the LCT device supply chain: Extending equipment delivery and installation lead times slightly (by a few weeks) did not affect the overall project delivery programme. Instead, it assisted in demonstrating that the DLC box was interoperable with LCTs from different manufacturers. All the aspects of the project were met within a 10% tolerance on the original budget on time.

The all-inclusive details of the outcomes of LV Connect and Manage have been covered below:

Live Trials: EV Charge Management (Import Limitation): This section demonstrates the design, build and operation of an ANM system for LV LCTs, mainly focusing on the import restrictions of power to EV charge points. The power was aggregated for each of the monitored charge points within iHost and subsequently compared to the set point limits. The charge points were controllable from 16A to 32A and controlled with varying degrees of set point resolution (from 4A steps to 0.5A steps) to establish the optimization of real-time import patterns. The cluster of 16 EV participants was configured into the LV ANM system. Each participant was assigned a

unique identification to keep their identity anonymous and safeguard their consumption data. Besides, individual demand profiles were not necessary since this project focused on the aggregated effects of LCT clusters on distribution transformer power flows.

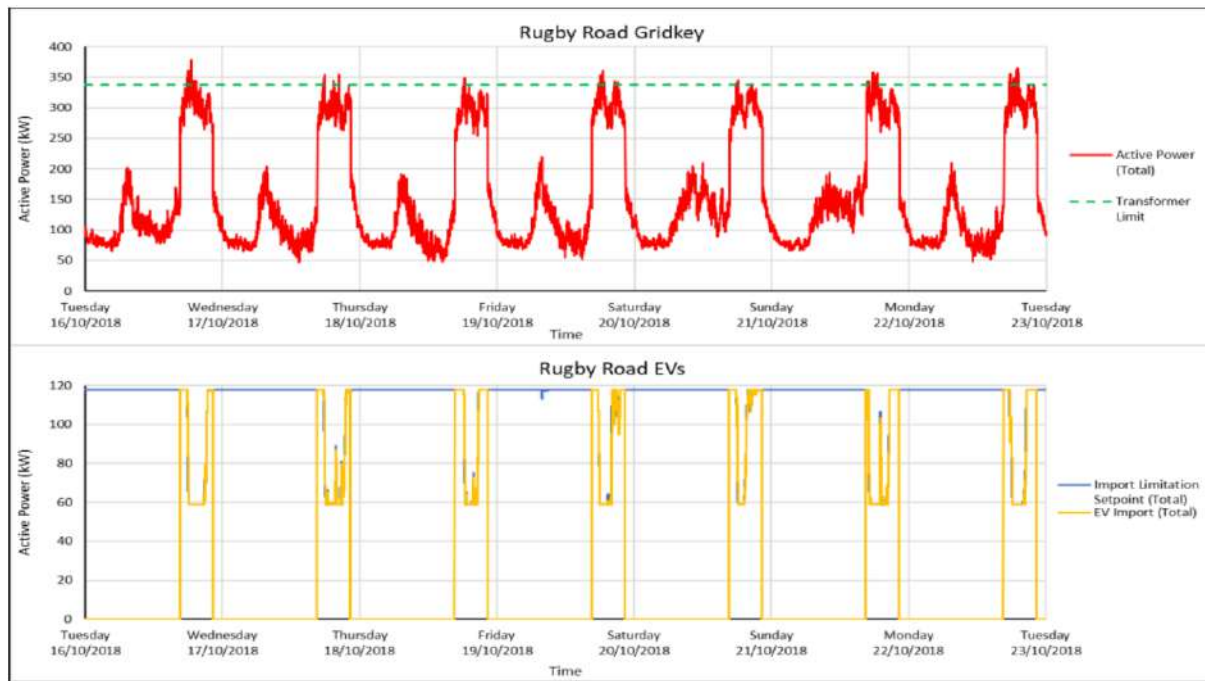

Figure 2.21: Operation of the ANM system for limiting the import of EVs (one-week view) (*LV Connect and Manage Closedown Report 2019*)_{xs}

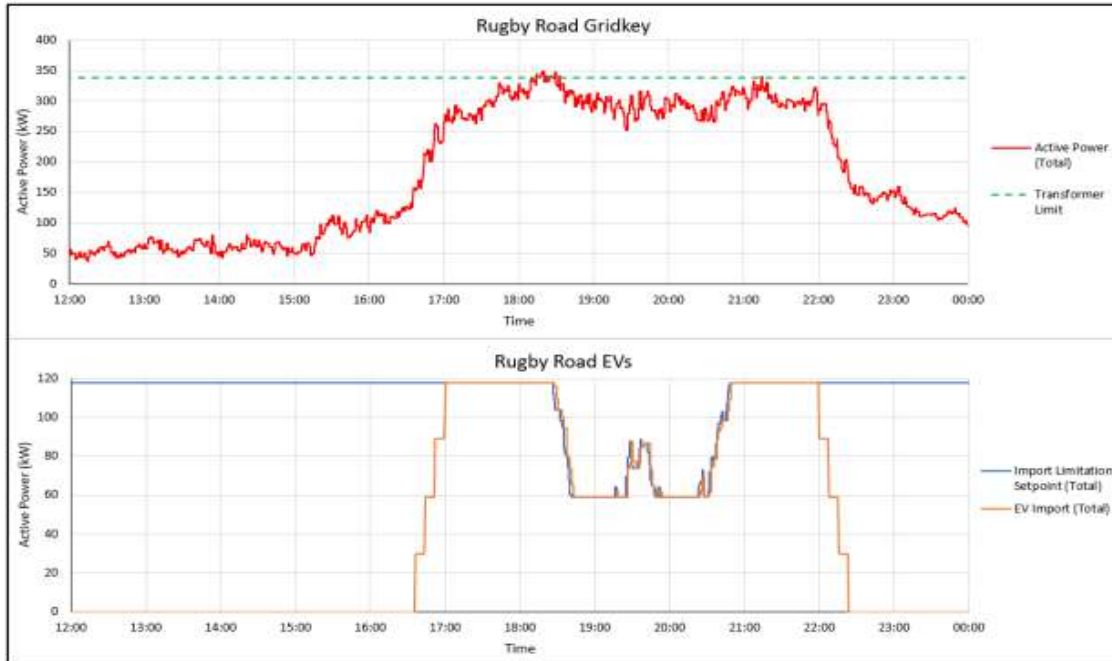

Figure 2.22: Operation of the ANM system for limiting the import of EVs (one-day view) (*LV Connect and Manage Closedown Report 2019*)

Live Trials: PV/Battery Charge Management (Export Limitation): The power was aggregated within iHost and subsequently tallied against the setpoint limits for each monitored battery system. The battery inverters were controllable in the range of 0A to 16A and able to receive a continuous scale of electrical currents to exhibit the optimization of real-time export patterns.

The LV ANM system was designed with a cluster of 12 battery energy storage participants. Each client participant was granted an exclusive identification similar to the import limitation trial to keep their identity secret and their consumption statistics protected. Furthermore, because the focus of this experiment was on the aggregated impacts of LCT clusters on distribution transformer reverse power flows, individual export profiles were not required or reported. The batteries were switched from self-consumption mode (which limits battery discharge to match residential demand) to grid-tied export mode during the testing (discharging the battery to the level required by the ANM system). This is the same as vehicle-to-grid (V2G) functionality. When it comes to the import limitation feature, the system works in reverse. The export of the batteries is controlled when a reverse limit on the distribution transformer is breached, and the power flow through the distribution transformer (in the forward direction) is raised. Because the penetration of PV and battery systems was insufficient to cause reverse power flow across the distribution transformer, the reverse power flow limit was artificially configured in the forward direction. Battery export is

restricted when the transformer power flow falls below the export limit (to raise the power injected by the distribution substation). The battery export is increased when the transformer power flow exceeds the export limit (to reduce the power injected by the distribution substation). This mode of operation could be utilized in the future to improve distribution network efficiency and reduce losses by supplying electricity locally within the LV network using local generation and storage devices.

Setpoint Response Times (over mobile networks): Within the ANM systems, this part measures the performance of setpoint commands supplied to the LCTs over mobile network communications. The trial using 3G roaming SIM cards, which provided more incredible speed (lower communication network latency) and robustness (as the SIM cards would automatically switch onto a different network provider in the event of a primary mobile network outage). In the following sections, the roundtrip communication times (from control trigger to readback of setpoint change) for the battery/inverter system trials and the EV charge point trials were documented in the following sections.

Battery/Inverter Systems: During the response time quantification study, 288 setpoint controls were generated. Within one minute, 276 controls (95.8%) were confirmed, and all controls were confirmed within 4 minutes.

EV Charge Points: During the response time quantification study, 7573 setpoint controls were triggered. Within 5 seconds, 7493 controls (98.9%) were verified, and all controls were validated within 10 seconds or the subsequent attempts.

Policies, Processes and Emerging Standards: LV Connect and Manage resulted in the following policies and emerging standards:

- A policy for the retrofit of Connect and Manage substation monitoring equipment.
- A process for standardizing the installation of Connect and Manage equipment (DLC boxes) into customers' homes; and
- A Technical Specification for Managed EV Charging Systems.
- For the deployment of this solution, WPD Policies and Standard Techniques have been developed and are accessible upon request.
- Technology Readiness Level Evaluation

Technology Readiness Level Assessment: At the commencement of the project, the Technology Readiness Level was a 5 (technology validation in a suitable environment). At the end of the project, the Technology Readiness Level was a 9 (the actual system had been 'flight

proved' through successful operations). I&C Storage and Smart Energy Isles are two other WPD projects that have used the DLC box component of LV Connect and Manage.

Learnings:

- BPL communication is unsuitable for transmitting control signals for EV control.
- For a wider adoption of the solution, standardization of communication and control interfaces to Low Carbon Technologies is required.
- For future projects, it is recommended that a testbed environment be incorporated as part of the project architecture to allow for low-risk integration and testing of technologies.
- WPD's consumers have become more aware of the critical role it plays in society due to the initiative. At the end of the project, all customers kept their LCTs. According to the proposal, similar recruitment tactics, mainly marketing and recruitment companies, should be used in future projects.
- Customers' data was protected in two keyways, both of which were built into the project delivery processes: (i) Allocating a unique ID to each customer (which anonymized the customer and allowed project-specific power systems project partners to use data without transferring personal data); and (ii) Aggregating customer load profile data (to safeguard the data of individual customers). According to the guideline, anonymity and, wherever applicable, data aggregation should be built into the data protection processes in future projects.
- The use of DLC boxes with mobile connectivity made remote commissioning easier, resulting in several advantages. Low-cost, established communications technologies (such as mobile communications) should be integrated into the solution architecture for future projects, especially when a new communications system is being trialed or an old communications system is being utilized in a new application.
- LV Connect and Manage quantified LCT control response times via mobile networks in great detail. The roundtrip timings for communications demonstrate that the mobile network is acceptable for managing LV LCTs, especially when aggregated over a population of controlled devices, with appropriate design mitigations for communication disruptions. The roundtrip time of communications and control systems should be measured in future projects so that the system's performance can be adequately assessed.
- During the clients' testing, purposeful swap-outs of the DLC boxes proved the simplicity and mobility of the DLC box solution. The time it took to switch over the DLC box was less than 10 minutes. The entire time for porting the solution was significantly influenced by

customer availability and travel time to the site. The necessity for portability should be incorporated in the solution design criteria for any DNOs intending to implement a DLC-type intervention.

- As DNOs migrate to DSOs, it is essential to remember that battery energy storage systems may be configured (by the end-user) to operate in various modes. This implies that the client may install the battery with the aim of self-consumption of the energy behind the metre. However, if rules change, the consumer may be enticed to alter their battery system to export power to the electrical grid. For future projects, it is suggested that the functionality of LCTs be carefully considered, notably how their functionality can be reconfigured by the end-user (or a third party such as an aggregator). It could result in inadvertent impacts on other systems, such as the electricity distribution grid.

Three key areas have been identified for further research and analysis:

- The development of LCT profiles.
- Revisiting the design principles of LV networks to account for the degradation of load diversity if LCTs continue to connect in an unmanaged and uncoordinated manner; and
- Standardization of a Technical Specification for Smart EV chargers in light of changed load duration curves.

2.6.3 Electric Nation

Project Category: Commercial Trial

Project Aim:

The objective of this project was to equip GB Distribution Network Operators with the tools and solutions to enable them to manage EV market growth by:

- Assessing the LV network to predict the zones/areas more susceptible to high EV charging load growth.
- Determining whether by using smart charging (unidirectional/ bidirectional) the requirement of grid reinforcement may be avoided or deferred.
- Procure and deploy smart charging solutions in network constrained locations.

Electric Nation was the world's largest home smart charging trial with nearly 700 EV owners taking part in the 18-month trial providing data of more than 2 million hours of car charging.

The smart chargers for the trial were supplied by Alfen and eVolt, and GreenFlux and CrowdCharge supplied the back-office systems that controlled power delivery and took instructions from drivers.

Trial participant spread throughout WPD's licence areas



Figure 2.23: Trial participants spread (Electric Nation, n.d.)

The trial was split into three sub-trials: blind (organisers limited charging to vehicle when demand was high during the early evening), interactive (participants used phone apps for controlling the charging), and incentivised (using ToU tariff and earn shopping vouchers if charge outside peak hours).

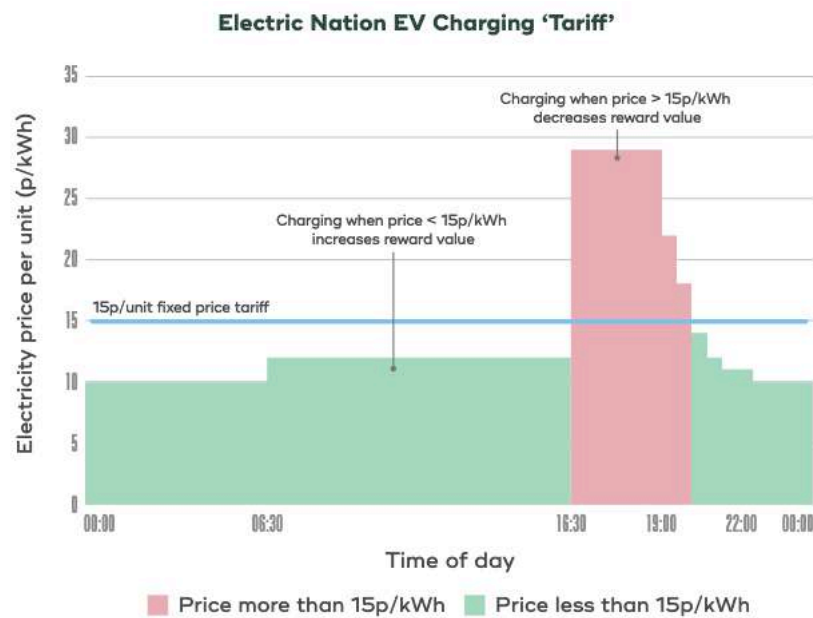

Figure 2.24: EV charging tariff (Electric Nation, n.d.)

Project Duration: 2016-2019

Key Learnings:

1. The project identified that demand management is technically feasible and EV users were also eager to participate in DR programs
2. Time of Use tariffs were also found to be effective in managing the EV charging load, especially when paired with a smart charging app.

2.6.4 Project Sciurus

Project Category: Demonstration Project

Project Aim:

- Address the technical challenges pertaining to V2G
- Create both technology and business cases to prove the economic, environmental and societal value of V2G.

Project duration: 2018-2021

Summary:

The initiative, named Project Sciurus, was taken in April 2018 by four UK-based firms, namely, OVO Energy, Cenex, Nissan and Indra, to conduct a rollout of V2G in customer's homes to accelerate the EV revolution and address the various challenges associated with its integration into the grid (Cenex, 2021).

The project has helped install 320 V2G units installed with 141 participant survey responses. The participants were provided with these units and an application to set their preferences for the charging parameters and control their vehicle's usability. The devices deployed for the V2G functionality were aggregated and optimized by Kaluza, an intelligent energy platform that works on introducing flexibility into the energy system by optimizing individual devices. The energy is exported for grid balancing services to generate revenue for the customers. Finally, the customers were given a basic scheme whereby they would get paid a fixed rate for every unit of electricity that they export from their vehicles. The designing of the V2G unit was as per the CHAdeMO certification. Nissan Leafs have been used by the EV users for this project as it is V2G compatible.

First, the V2G charge point data and the household demand data from 2020 was cleaned and analyzed. The V2G data was then cross-referenced with the responses from the customer's survey to link the data to customer archetypes. Finally, the data was input into the Cenex REVOLVE model to assess potential revenue for different customers, periods and input assumptions.

A histogram of annual energy requirement for charging was generated based on the distance travelled by each EV. The mean annual equivalent driving energy was determined to be 1,757 kWh. The time that the EV is plugged into the V2G charge point and available for charging (i.e., availability) was calculated for each charge point. The responses from the participant survey also revealed that most of the participants plug-in their EV at their residences after each trip (almost 75%), constituting a behavioral change compared to normal EV charging behavior, typically every few days. The charge point data were also analyzed to understand the charging behavior of the EV users.

The analysis of household demand data has been performed using the Cenex REVOLVE model, a suitable foresight optimization model capable of simulating large numbers of EVs' charging/discharging behavior at a half-hourly resolution over a year. The model optimizes individual EVs' charging/discharging behavior based on the optimal values of import and export tariffs. The model optimizes the EV charging/discharging behavior in weekly blocks. Each EV in the model has an associated driving energy and annual plug-in availability data set along with the local demand of the site. The charge point is assumed to be behind the meter, and so the local demand can be offset by discharging the EV. The model charge points can also be aggregated and offered to provide grid services. The model stacks the available flexibility integrated into the charge points to build up the grid service product window requirements. A minimum capacity of power must be held in either an upwards or downwards (or both) direction for the specified grid service periods for delivering a grid service. During the entire service period, the model must also hold sufficient stored energy/demand reduction (or battery headroom) to meet the grid service product's minimum length of the call. Since the model offers precise foresight, it provides an upper bound on the revenue that could be earned through the V2G options modelled. The model first performs an unmanaged run to quantify the value provided by V2G. All EVs are charged up to full capacity as soon as they are plugged in to create an energy cost baseline. Subsequently, an optimized run is executed in which the charging and discharging behavior are optimized based on minimum cost.

Key learnings:

- The project found statistically vital evidence that the driving energy of different user archetypes differ from the data collected within the trial. Nevertheless, it could not establish from the data that the EV availability varies significantly between them.
- By the conclusion of the trial, the V2G hardware and installation cost were around INR 3,82,844 (EUR 4346) higher than a smart chargepoint. But, with mass production, this cost will potentially come down further. A cost of approximately INR 1,03,488 (EUR

1174.9) would indicate the payback period for V2G could be below five years for those on tariff optimization only.

- The partners stated that it was important for their next EV purchase to have V2G capability, illustrating that their initial concerns about battery degradation, reliability and costs were relieved, attesting to the demand for the technology.
- With the help of the 2020 data, the project found that using the optimization model, the average annual revenue possible with a V2G chargepoint was INR 35,189 (EUR 400)⁵. If FFR was included as a revenue stream, this figure rose to INR 53,094 (EUR 602.8). However, INR 12,419 (EUR 141) of this revenue could be captured by an optimized Smart (uni-directional) chargepoint.
- A V2G chargepoint providing tariff optimization and Dynamic Containment would be able to capture up to INR 75,017 (EUR 851) (an increase of INR 6,621/kW (EUR 75.17/kW)) per year.
- The value addition of V2G by tariff optimization is highly correlated to the volume of energy exchanged, while the value addition by providing FFR or Dynamic containment is correlated to the amount of time the EV is plugged-in and available.
- Spikes in price in the wholesale market (if obtainable by V2G) provide a strong revenue possibility. In weeks with these spikes, V2G achieved twice the revenue than the average week.
- EVs with battery sizes of 40-kWh and above are able to generate about 20% higher annual V2G revenue than smaller battery sizes.
- The V2G capability in EVs encourages brand support, with 61% of participants surveyed stating that they would be likely to purchase a Nissan EV if Nissan was the only manufacturer with fully electric V2G-enabled vehicles available in the UK.
- Although the cost of V2G hardware has been reduced significantly by this project, the expenses are still too steep for most customers and make the financial business case stack up for the operator. Hence, a decrease in the incremental cost of a V2G chargepoint (above a Smart chargepoint) is necessary. An additional stream of revenue to a tariff-based optimisation must be taken into account for assuring the viability of the business case. FFR, DC or the Balancing Mechanism may provide these possibilities.

⁵ £ 1 = INR 103.5

- The initial financial expenditure for customers should be reduced through reductions in hardware costs or a revamped scheme.
- EVs with batteries of 40 kWh and above should be targeted in comparison to the smaller batteries.

2.6.5 Electric Nation Vehicle to Grid

Project Category: Commercial Trial (*Electric Nation: Vehicle to Grid*, n.d.)

Project Aim:

- Impact of V2G charging on the low voltage (LV) electricity network, utilizing end-user trial charging data and analysis.
- To what extent V2G can assist with management of LV network demand.
- Provide recommendations of policy and commercial frameworks on V2G services.

Project Duration: 2020-2022

Results: Not Published

Chapter 3. United States of America

3.1 Background for policy making environment

The USA has the second-highest stock of plug-in electric vehicles, right after China. Its stock represented roughly 20% of the global EV stock (Cui et al., 2020). The federal and state policies and incentives have played a major role in the development of the large EV market in the USA. In 2011, the federal govt. set the goal for the USA to being the first country with 1 million EVs on the road by 2015. Further in 2008, the San Francisco Mayor and the Oakland Mayor announced a nine-step policy plan for transforming California into the 'EV capital of the U.S.' (*Mayor Office Press Room*, n.d.). The American Recovery and Reinvestment Act was then launched by the then President of the USA which allocated INR 17,794 crore (EUR 2.02 billion) in federal grants to support the development of next generation of EVs and batteries. Tax credits were then rolled out for a new qualified plug-in EVs from the American Clean Energy and Security Act of 2009, for the purchase of EV with a battery capacity of a minimum 5kWh. The tax credit was worth INR 1,85,360 (EUR 2100) plus INR 30,918 (EUR 351) for each kWh of battery capacity exceeding 5kWh. Apart from the federal incentives, each state has its own set of incentives to promote the growth of the EV sector.

State and local governments in the US play a major role in the development of EV charging infrastructure as guided by federal government policies.

The Federal Energy Regulatory Commission has no direct control of retail electric rates due to the decentralised electric utility system. However, several states, including Colorado, Michigan, Minnesota, and Wisconsin, subsidise the cost of purchasing EV chargers for users who opt into residential Time-of-Use (TOU) plans.

3.2 EV Charging infrastructure policies and regulations

Table 3.1: EV Charging infrastructure policy in the USA

Policies Enabling EV charging on supply-side		
Element	Policy Instrument	Measures
The incentive for launching the EV charging market	Tax incentives	30% tax credit up to a maximum of INR 74,144 (EUR 842) for the cost of installing an EV charging station. Expired at the end of 2017. (Hove & Sandalow, 2019)
	Highway EV charging corridors	INR 33,364 crores (EUR 3.8 billion) in loan guarantees are available for EV charging infrastructure along the corridors.





	Los Angeles Department of Water and Power incentive	Businesses offered up to INR 2,96,576 (EUR 3370) per charger installed.
Prioritization in terms of EV characteristics and social geography	Highway EV charging corridors	Federal government designated 48 EV charging corridors along 25,000 miles of major U.S. highways to encourage EV adoption. The plan calls for EV charging stations to be installed at least every 50 miles within the corridors and mandates new signage to help EV users locate charging stations in 35 states. (Magill, 2016)
Policies Enabling EV charging on demand-side		
Element	Policy Instrument	Measures
Specification of minimum facilities to be provided at charging stations	California CalGreen Code	Residential buildings with over 17 units to have a minimum of 3% of all parking spaces ready for future installation of EV chargers. The Code specifies wiring practices, labelling, EV charging space dimensions, and markings and accessibility. (Hove & Sandalow, 2019)

The table is not truly reflective of the USA policies to promote EV uptake, owing the federal state policies influencing the topic. Overall, on the supply side, there are federal and state grants and fiscal incentives available to establish charging stations across different social geographies. Including a policy to facilitate inter-state mobility by ensuring a charge point made available at least every 50 miles across highways. On the demand side, local state policies take precedence, for example in the case of California, there are specific codes that apply to installation and integration of the charge point to the grids.

3.3 EV Charging infrastructure

In the USA, the EV chargers are categorized into Level 1 Chargers, Level 2 Chargers, and DC Fast Chargers, as provided below.

Level 1 Charger	Level 2 Charger	DC Fast Charger
2 to 5 miles of range per hour of charging	10 to 20 miles of range per hour of charging	60–80 miles of range per hour of charging

Charging through a 120 V AC plug, with maximum power up to 3.3 kW	Charging through a 240V or 208V electrical service. The charging can accommodate up to 80A of current and 19.2 kW.	DC fast chargers enables rapid charging with high power ratings. There are three types of DC fast charging systems, SAE Combined Charging System (CCS), CHAdeMO, and Tesla.		
				
J1772 charge port	J1772 charge port	CCS charge port	CHAdeMO charge port	Tesla charge port

There are a total of 45,064 charging stations in the USA of which 41,632 are public charging stations and 3432 are private captive charging stations as of April 2021 (Afdc, 2021). There are a total of 118,710 charging outlets of which 104977 are in public charging stations. The share of connector types among the charging stations in the public charging stations is given in Figure 3.1. 67% of the charging outlets are fitted with a standard J1772 connector. There are 41,043 charging stations with 97,230 AC charging outlets. Of those, 4,601 charging stations and 11,658 charging outlets have a Tesla Connector, while the rest 85,572 charging outlets have a SAE J1772 connector. Comparatively, there are currently only 3,433 Level 1 charging outlets spread across 1,083 charging stations (Afdc, 2021).

For DC chargers, there are a total of 17,755 DC charging outlets in 5,077 charging stations. Of those, 6,472, 4,860, 9,868 charging outlets have CCS, CHAdeMO and Tesla connectors respectively (Afdc, 2021).

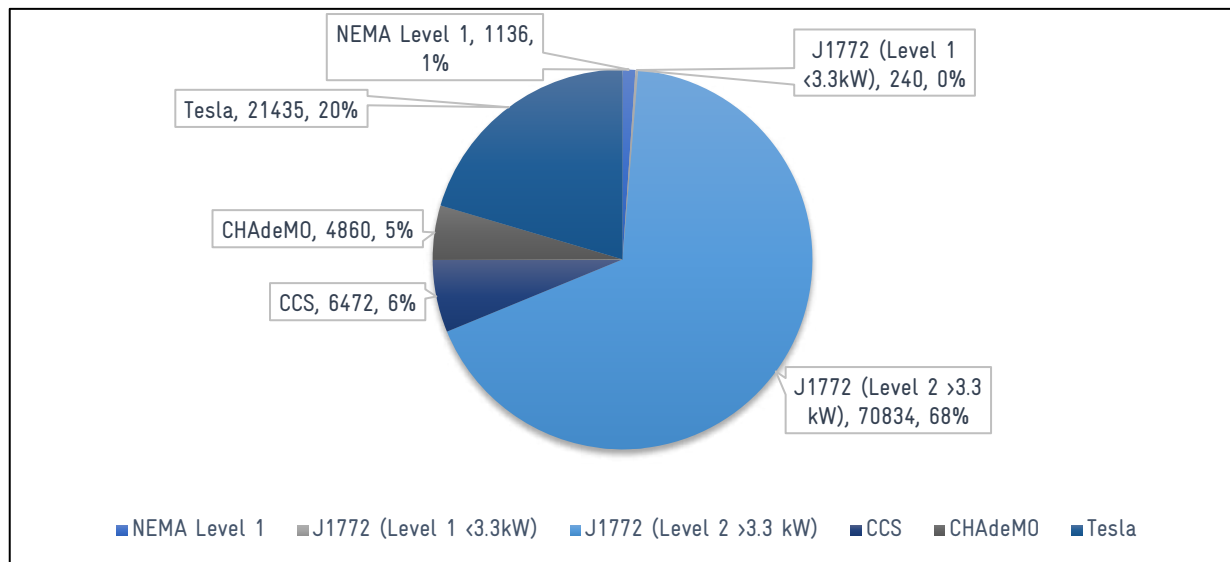

Figure 3.1: Share of connector types among chargers in Public Charging Stations in USA (Afdc, 2021)

Based on the accessibility of chargers, the charging stations can be categorized into private and public chargers. Private chargers can only be accessed by a predefined specific set of users. The distribution of chargers among public and private charges is given in Figure 3.2. As can be seen, Level 2 chargers with J1772 connectors are the most prevalent among both private (captive) and public chargers. However, fast DC chargers are most prevalent among public charging stations.

As of 2019, there are approximately 1.56 million private (residential) EV chargers in USA (IEA, 2020), with almost all EV owners expected to have an EV charging cable that can be plugged into any standard outlet, or a dedicated EV charger supplied by the EV manufacturer. Likewise, almost all the private (residential) chargers are expected to be AC chargers with maximum power output of 22 kW.

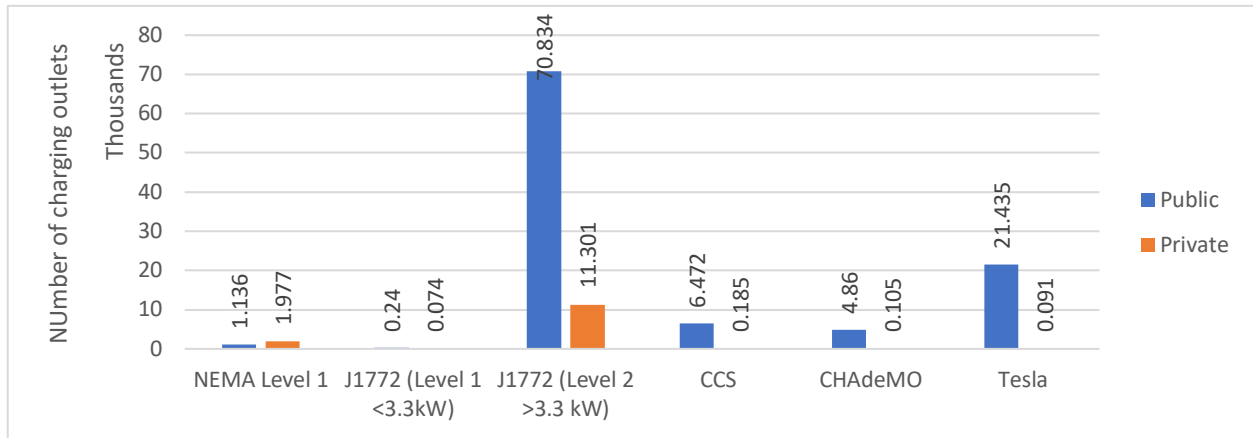

Figure 3.2: Number of charging points based on connector type and accessibility in USA (Afdc, 2021) Here private chargers imply captive private chargers

3.4 EV demand status

The total EV stock and the annual sales of EV are given in Figure 3.3. There is a total of 879,320 registered BEVs and 564,777 registered PHEVs in the USA. The annual sales show that, post-2011 till 2013, PHEVs had a higher demand than BEVs, but since 2013, the annual sales of BEVs have consistently surpassed that of PHEVs. Total EV sales fell by 10% in 2019 versus 2018 (IEA, 2020), and the bulk of the sales were because of the Tesla Model 3 as shown in Figure 3.4.

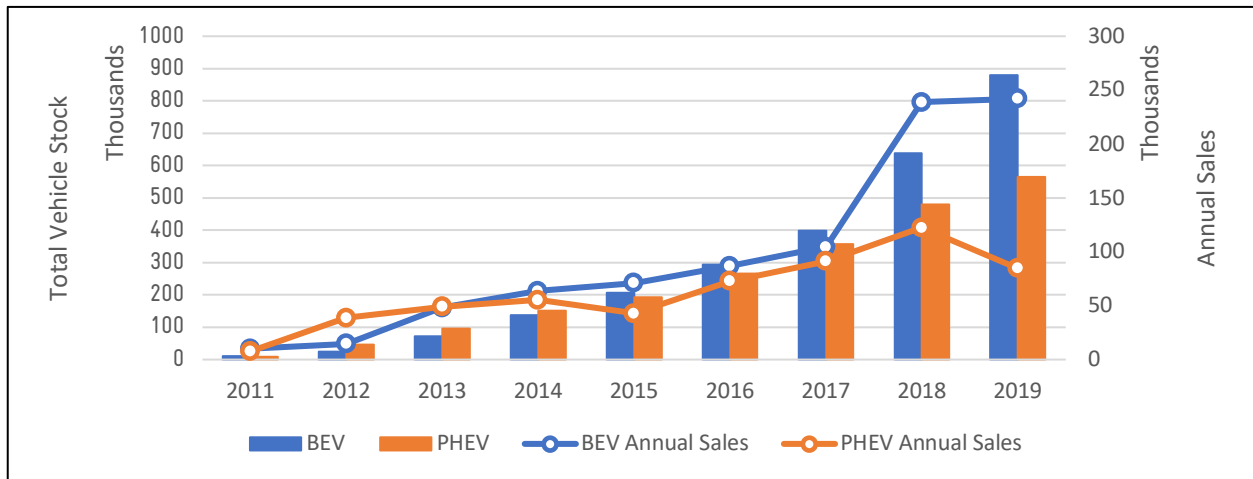

Figure 3.3: BEV/PHEV market statistics in USA (Hybrid-Electric, Plug-in Hybrid-Electric and Electric Vehicle Sales, 2020)

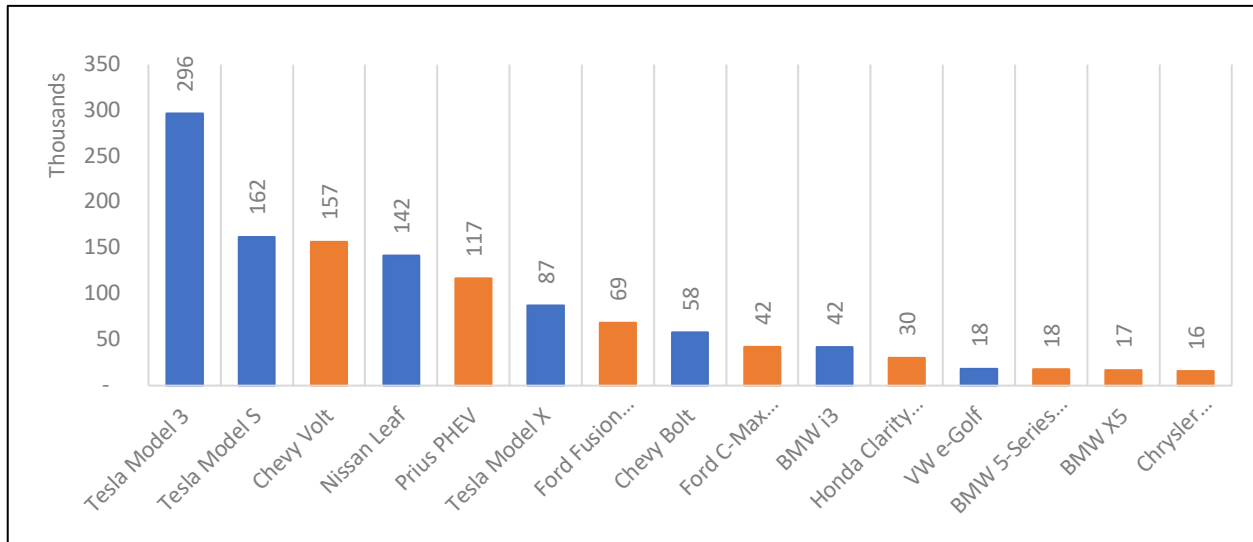

Figure 3.4: Top 15 BEV/PHEV models in USA (USA.gov, 2019)

Figure 3.5 shows the number of models offered by different manufacturers in USA which are powered by alternate fuels, thus showing the evolution of the alternate fuel vehicles segment. In the late '90s and early 2000s there was a brief window when EV's gained some popularity which quickly waned. The modern EV push started in around 2008, and currently, electric vehicles are the most popular alternative fuel vehicles, with the highest number of models on offer by different manufacturers.

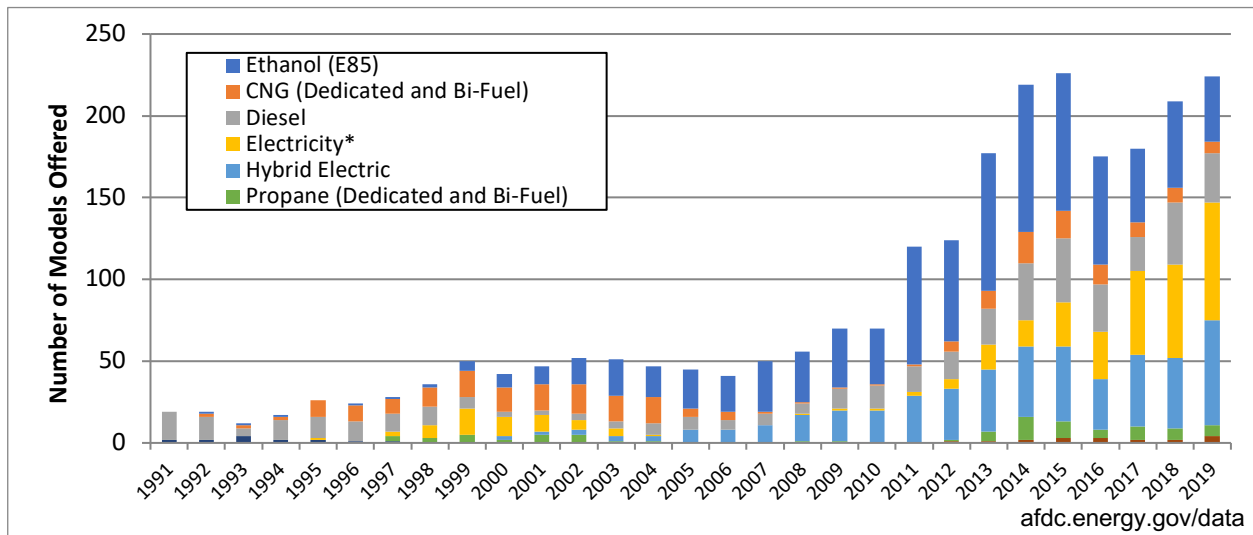

Figure 3.5: Light duty alternative fuel vehicles, hybrid electric vehicles offered by vehicle manufacturers (USA.gov, 2020)

3.5 EV integration

The analyze the impact of EV penetration on the U.S. electric power system, Grid Integration Tech Team (GITT) and Integrated Systems Analysis Tech Team (ISATT) conducted a study in 2019 (US Drive, 2019). As per the study, EV sales in 2030 are estimated to total of 320 thousand (2% of new vehicle sales), 2.2 million (12%), and 6.8 million (40%) in the low, medium, and high scenarios, respectively. These scenarios result in a total EV fleet size (i.e., cumulative vehicle sales) of 3 million (1% of the total passenger vehicle fleet), 14 million (5%), and 40 million (15%) vehicles by 2030, respectively as given in Figure 3.6. Assuming each EV travels 19312 km (12,000 miles) annually, consuming approximately 187 Wh/km (300 Wh/mi) of energy, with 4.9 % system losses for transmission and distribution, then each EV will require 3.8 MWh/year of energy generation. For the 2030 low, medium, and high EV sales scenarios, this translates into 1, 8, and 26 TWh of incremental energy generation respectively, which is relatively small compared to historical data, Figure 3.7

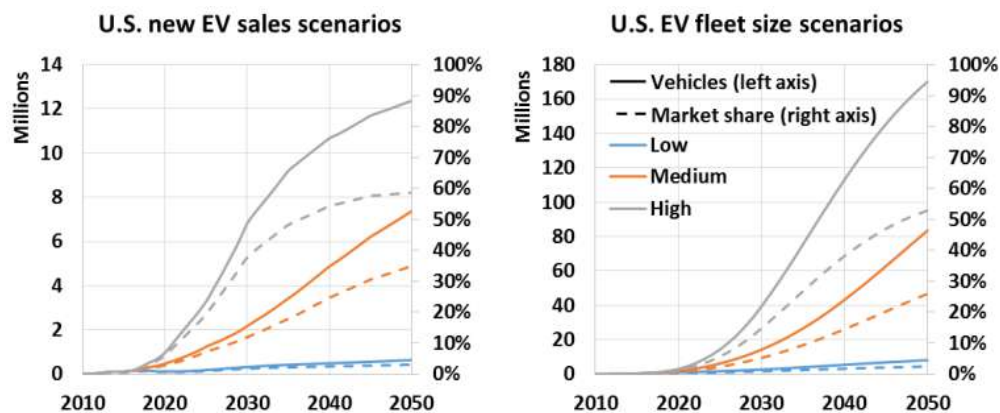

Figure 3.6: EPRI low, medium and high PEV market penetration scenarios, showing new annual EV sales (left) and total fleet size (right). Solid lines correspond to number of vehicles (left axis) and dotted lines correspond to sales share (right axis) (US Drive, 2019)

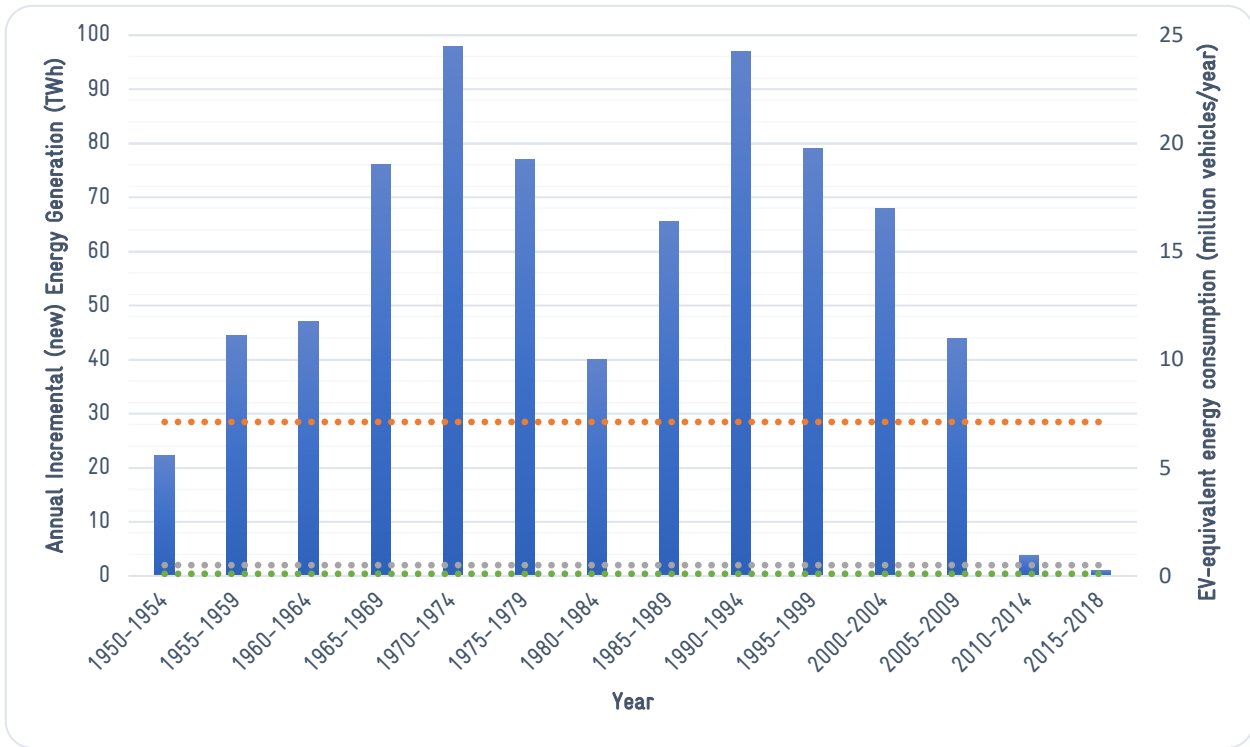

Figure 3.7: Historical data showing U.S. annual incremental energy generation, averaged in 5-year increments. The energy requirement for the three scenarios is also shown. (US Drive, 2019)

The RECHARGE project led by the National Renewable Energy Laboratory, in partnership with Sandia National Laboratory and Idaho National Laboratory takes a utility-down approach to charge management in addition to performing a detailed assessment of EV impacts on the

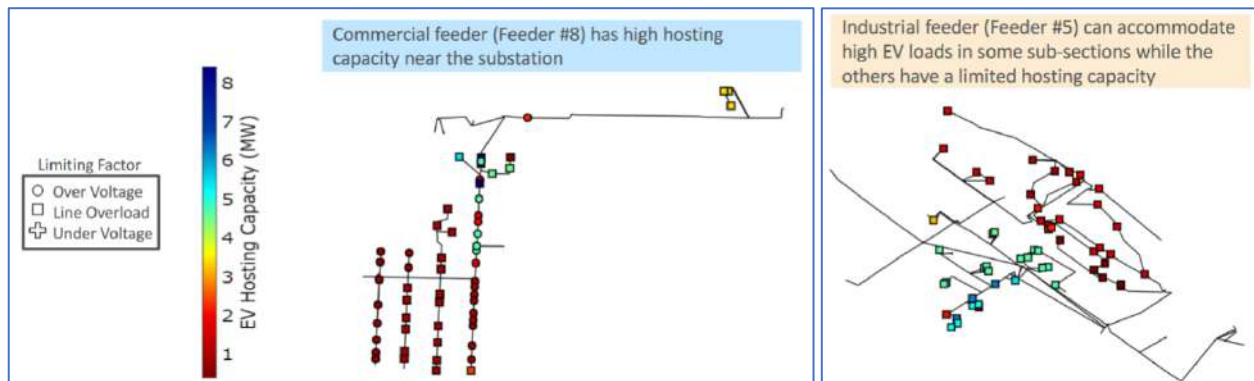

Figure 3.8: Hosting capacity of commercial and industrial feeder (Meintz, 2020)

distribution networks of Minneapolis and Atlanta. As per the analysis, EV hosting capacity vary by location as well as feeder type. Distance from the substation is also a key metric in the determination of hosting capacity. Line congestion has been observed as the most common

limiting factor which is followed by under-voltage issues as given in **Error! Reference source not found.** (Meintz, 2020).

Of the total energy consumed by the U.S. which is estimated to be about 100 quadrillion BTUs in 2020, only a third of that is used for actual work, while the remaining being wasted as losses. Electrification of the entire U.S. fleet and, along with expanded solar and wind generation is expected to not only reduce carbon emissions by 30%, but also reduce primary energy consumption by 13% (Denning & He, 2021).

Nuvve Corporation, headquartered in San Diego provides V2G solutions, which includes their own EVSE coupled with the smart charging done through their own Grid Integrated Vehicle (GIVE) application. The Nuvve PowerPort AC charging station meets the SAE J3068 charging standard, enabling up to 99kW of power with 3-phase AC charging. It can also provide up to 19kW of power with single phase (NUVVE, n.d.). Nuvve is also participating in a program to deliver resource adequacy to local utility San Diego Gas & Electric and University of California San Diego's campus microgrid. They supported the grid by strategically reducing electricity demand through discharge of lithium battery during critical peak load periods, reduction of V2G electric vehicle loads, injection of energy into the campus grid, and increased self-generation at the university's cogeneration power plant.

Nuvve and Blue Bird Corporation, the leading independent designer and manufacturer of school buses, recently announced the availability of Blue Bird's Vision Type C and All American Type D electric school buses enabled with Nuvve's V2G technology (GCR, 2020).

3.5.1 Ancillary Services

Controlled charging of EVs can be used to provide ancillary services such as frequency and voltage support services. In Pennsylvania, New Jersey, and Maryland interconnection (PJM) Regulation Market, generation and demand resources must be able to provide a minimum of 0.1 MW of regulation capability in order to participate (PJM, 2021). The same holds true for Demand resources which must also be able to provide 0.1MW of regulation capability. Demand resources are also allowed to participate in Synchronized Reserve Markets of PJM provided that the resources are able to decrease their load in response to the signal from PJM within 10 minutes. Demand resources, are however, not allowed to participate in PJM's Non-Synchronized Reserve Market. Among demand resources, PJM has listed battery storage as one of the viable resources that can provide regulation service and EV has been considered as one of the types of battery storage.

The demand resources participate in the ancillary markets under the direction and control of the Curtailment Service Providers (CSP). It is the responsibility of the CSP to provide for each location the load reduction method and the associated load reduction capability. The demand resources must also be equipped with the necessary meters to record electrical usage at the sampling rate as required by PJM. The interval of data collection must be sufficient to provide PJM with hourly, one minute of real time load data as applicable to the market. If the load reduction is not directly metered by PJM, it is the responsibility of the CSP to forward the meter readings within 60 days of the event to be eligible for monetary benefits.

Power Quality Issues

In order to analyze the impacts of EV charging on the power quality of the distribution system, the data was collected at Electric Avenue that is located on the Portland State University Campus site having five Level 2 chargers and two Level 3 chargers (Bass & Zimmerman, 2013). The Level 2 chargers are single phase with charging power between 4-20 kW, while the Level 3 chargers are CHAdeMO chargers with power rating between 20-50kW. For measurement of harmonics at various points in the charging cycle, 70 ms long sets of current readings were logged. The data was collected at a resolution of 256 points per 60 Hz cycle. The logged data was then broken into magnitudes and angles at various frequencies using Fast Fourier Transform (FFT). From the harmonic spectrum the total harmonic distortion (THD) for each charger was determined.

The THD varies with the course of the charging cycle, with generally low THD seen during the initial phase of charging, however worsening towards the end of the charging cycle. The charge cycle typically draws a larger current, that decreases as the battery SOC increases, shown in Figure 3.9. Though the THD may increase, the actual absolute deviation in the current is actually decreasing, however, since the fundamental component is also getting smaller, so the THD comes out to be of higher value.

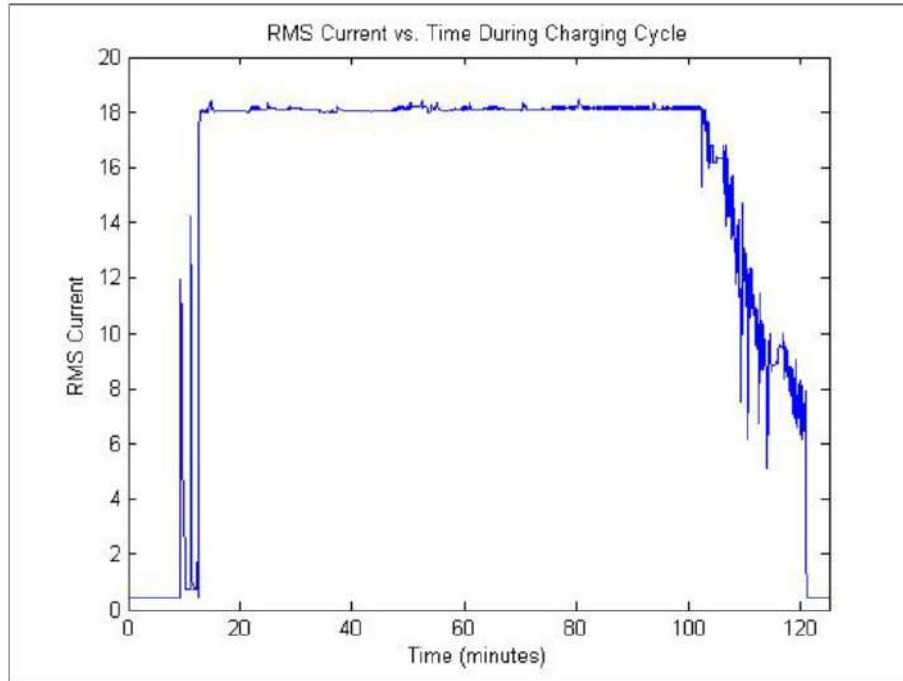

Figure 3.9: The RMS current of a charger during a charging cycle (Bass & Zimmerman, 2013)

THD for a single-phase charger

As seen in Figure 3.10, initially the current waveform is nearly sinusoidal implying that the contribution of harmonic components is very less. Small harmonic components can be seen in the 180 Hz, 300 Hz, and 420 Hz, which corresponds to the 3rd, 5th, and 7th harmonic.

As EV batteries charge up, to completely fill up the battery, the charging current reduces, and the charging goes into a 'trickle charge' state. This reduction of current is accompanied by higher harmonic distortions, as shown in Figure 3.10.

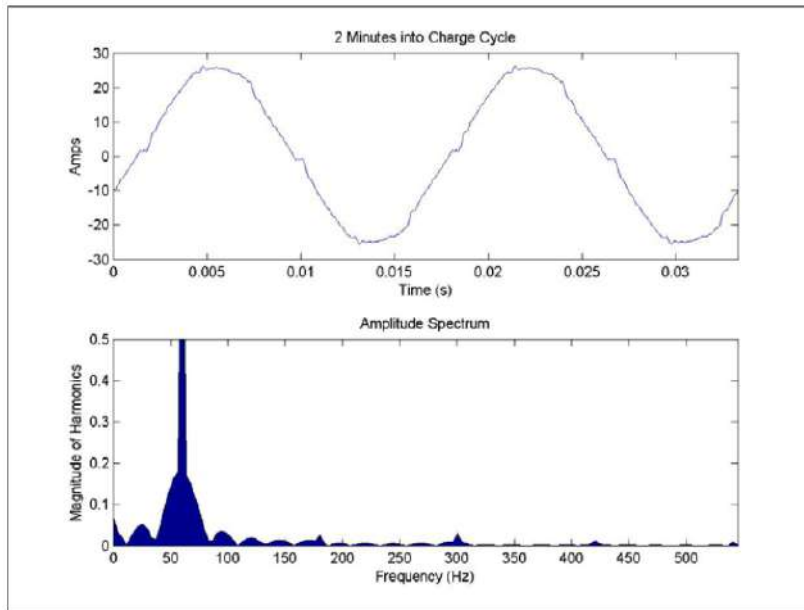

Figure 3.10: For 2 minutes into the charging cycle the current waveform (top) and its harmonic spectrum (bottom) (Bass & Zimmerman, 2013)

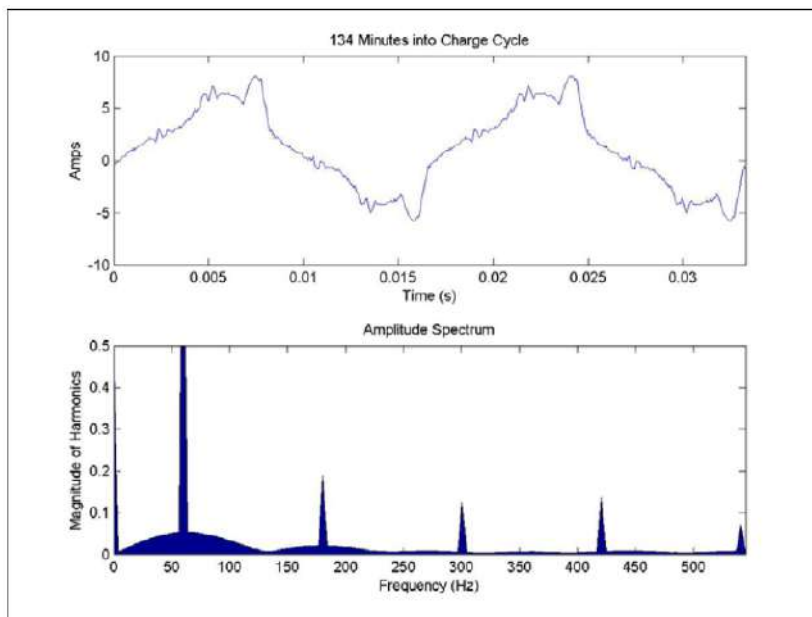

Figure 3.11: For 134 minutes into the charging cycle the current waveform (top) and its harmonic spectrum (bottom) (Bass & Zimmerman, 2013)

Table 3.2: THD for Level 2 charger at different points of the charging cycle (Bass & Zimmerman, 2013)

		Time in Charging Cycle (minutes)						
		2	33	63	92	110	128	142
	3rd	0.1	3.14	0.21	0.25	0.34	0.34	0.73

Harmonic (%)	5th	0.16	3.4	0.09	0.1	0.16	0.18	0.2
	7th	0.06	1.22	0.08	0.04	0.13	0.09	0.27
	9th	0.09	0.85	0.05	0.04	0.08	0.05	0.24
THD(%)		3.7	5.6	4.1	6.2	7.2	6.3	16

THD for a DC Fast Charger

The input to a DC fast charger is 3 phase AC. The waveforms for the AC side during DC charging are shown in Figure 3.12. It can be observed that the harmonic content during the initial charging period is significantly lower, even though the THD can be higher as described above.

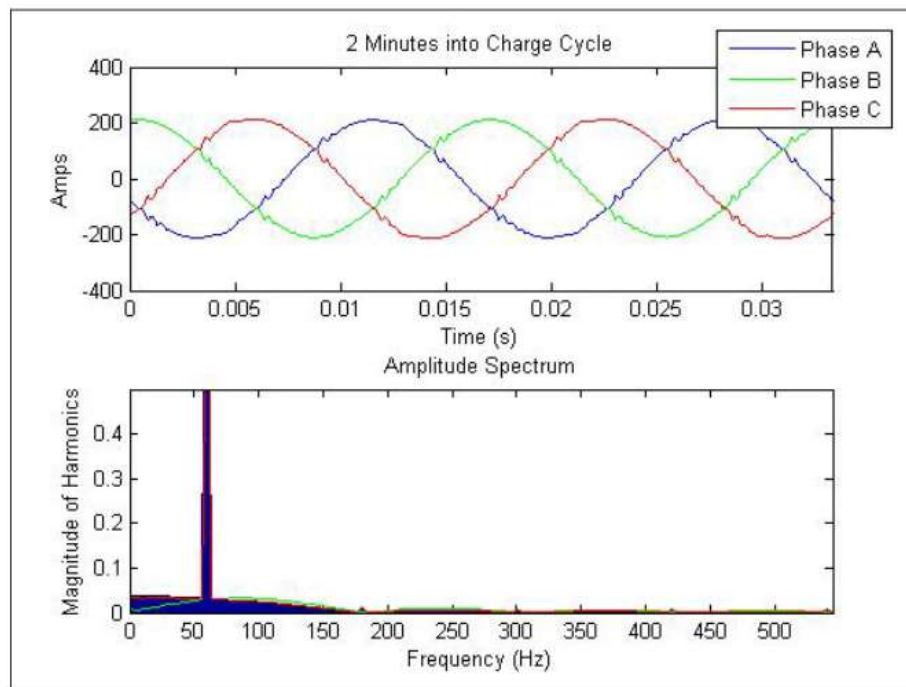

Figure 3.12: For 2 minutes into the charging cycle the current waveform (top) and its harmonic spectrum (bottom) (Bass & Zimmerman, 2013)

Later into the charging cycle, higher frequency components can be seen at the 3rd, 5th, 7th and 9th harmonics as shown in Figure 3.13. These harmonics distort the wave shape which can lead to phase imbalance and flow of current through the neutral conductor, thus affecting the power quality in the distribution feeder. The THD content of the three phases during different periods of charging has been given in Table 3.3.

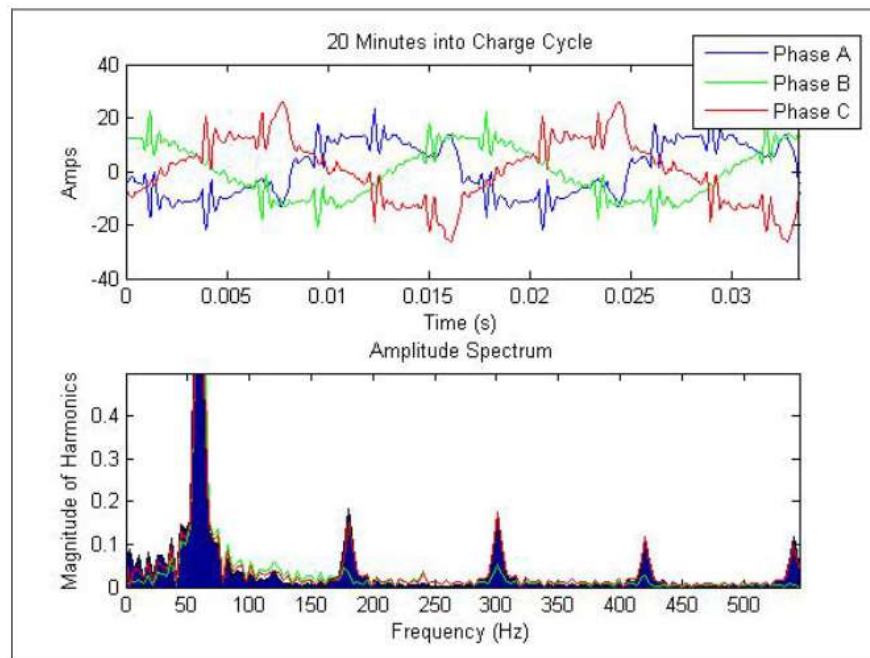

Figure 3.13: For 20 minutes into the charging cycle the current waveform (top) and its harmonic spectrum (bottom) (Bass & Zimmerman, 2013)

Table 3.3: THD at different phases in different times of the charging cycle (Bass & Zimmerman, 2013)

		Time in Charging Cycle (minutes)					
		2	7	10	17	23	29
THD(%)	Phase A	2.2	7.1	6.8	15.9	18.9	31.2
	Phase B	2.1	7.1	6.8	15.9	18.9	20.3
	Phase C	2.2	7.1	6.8	15.9	18.9	27.7

Total Demand Distortion

Total demand distortion (TDD) is considered as a better metric to analyze the harmonic content as it relates the magnitudes of the harmonics to the loading capability of the circuit. Data for calculation of TDD was collected at the point of common coupling, where all the branches of the individual chargers aggregate into the distribution feeder. The TDD calculations at five-minute intervals when all the five chargers are active is shown in Figure 3.14. It can be observed that even though the THD was high at the later stages of the charging cycle, the magnitude of the distortion was low, due to which TDD is lower for the later stages of the charging cycle.

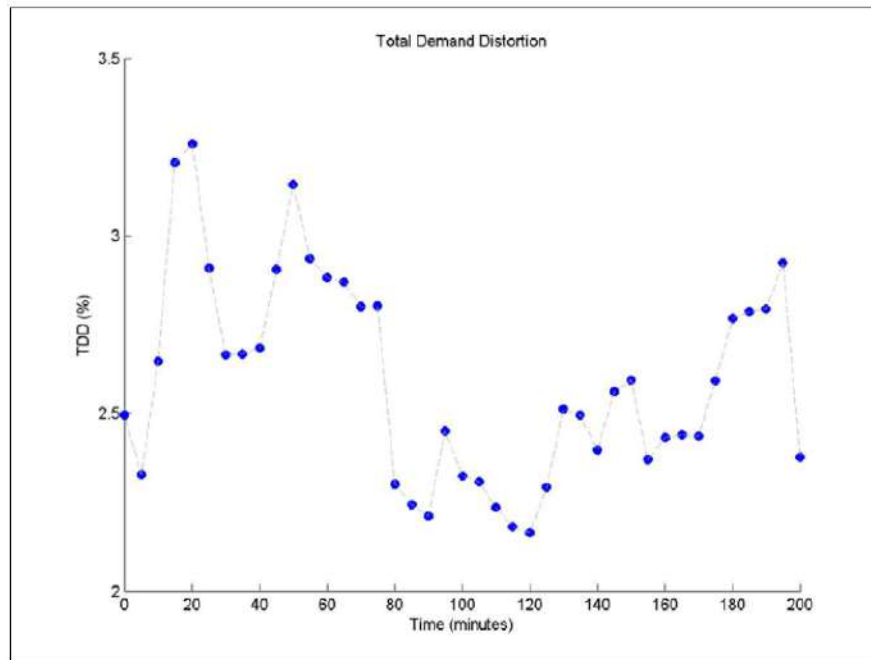

Figure 3.14: TDD at the feeder when all 5 chargers are active (Bass & Zimmerman, 2013)

3.5.2 Frequency regulation service using EV fleet

Frequency regulation is an ancillary service that manages the generation with real time load to maintain the grid frequency at the nominal value during normal grid operation. The entities participating in this service need to guarantee to be able to adjust their generation during a specific time periods based on the regulation signal sent by the operator. In Electric Reliability Council of Texas (ERCOT), participants participating in frequency regulation services are paid irrespective of whether they were actually required to provide the service or not, i.e. they are paid for even being on standby (CCET, 2015). ERCOT has one of the highest penetrations of wind power plant installation in the USA and due to the stochasticity of wind, the requirement of regulation services increases. The additional regulation required for wind installation is shown in Figure 3.15 (CCET, 2015).

In ERCOT's Fast Response Regulation Service (FRRS), the signals from ERCOT are to respond to in full within one second of signal receipt. Additionally, participants in FRRS can also respond automatically when the frequency deviation is equal to or greater than 0.09Hz. A good resource for provision of FRRS is the utility scale batteries. As the response characteristics of EVs are similar to that of batteries, so ERCOT began a pilot to test the capability of EVs for provision of FRRS in 2015.

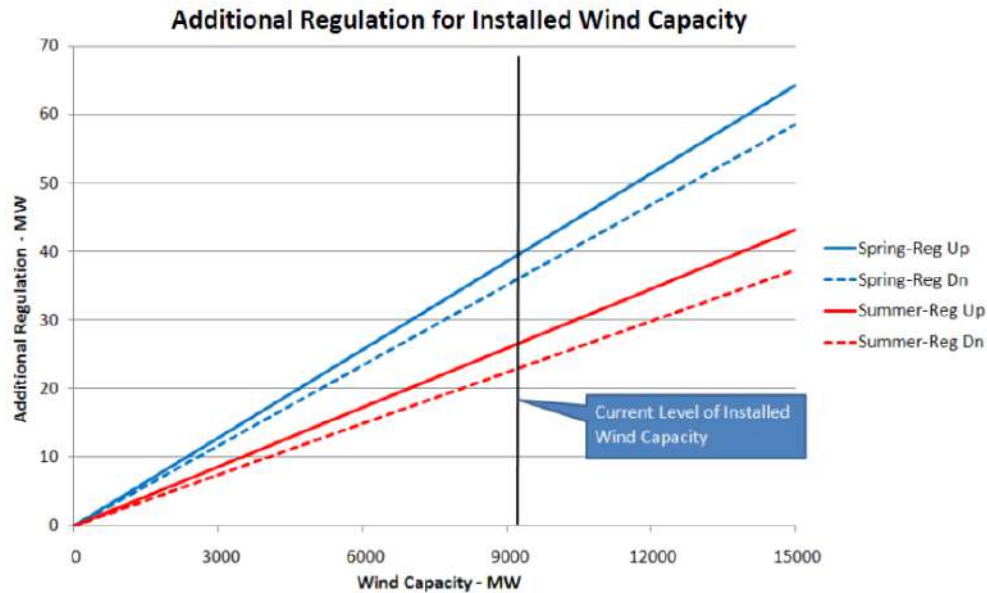

Figure 3.15: Additional regulation service requirement with increasing wind power in ERCOT assuming 5-minute nodal dispatch (CCET, 2015)

For the purposes of this pilot, a fleet of 11 EVs were used. These EVs are typically utilized for deliveries during the night and charged during the day. Since the requirement of regulation services is also the highest during the daytime and evening time, the selected EVs were able to participate in FRRS. An EV aggregation control system was developed that would control the EV charging based on either control signal from ERCOT or when the detected deviation in grid frequency was higher than 0.09 Hz. FRRS services were bid in intervals of 1 hour. The architecture of the pilot is shown in Figure 3.16 and includes the EVSE, the energy management system, the aggregator and the FRRS meter.

The FRRS meter was custom built using a National Instruments CompactRIO DAQ along with the associated voltage, current and relay modules. Using their designed FRRS meter they were able to log fleet power consumption at 40Hz. A secure physical network interface to ERCOT in accordance with FRRS pilot requirements was also designed, using a Qualified Scheduling Agency (QSE). A distribution network protocol 3 (DNP3) interface to the QSE Remote Terminal Unit (RTU) was implemented over a secure virtual private network (VPN).

Key requirements identified for the project success:

- Ability to monitor grid frequency and detect deviation of 0.09 Hz. The final designed system was able to detect frequency deviations of 0.001 Hz.
- Ability to implement FRRS protocol within 1 second of either detected deviation or ERCOT instruction.

- Ability to monitor and log fleet power consumption at a minimum of 32 Hz during an FRRS bid.

Data Collection

The Data Acquisition system (DAQ) collected voltage and current measurements from each EVSE every 25ms. These readings were then summed to provide the total power consumption of the fleet. The EV aggregation system also computed the bid capacity available every 25ms. The collected data was then logged into a file for each bid hour.

Operation Procedure

Upon receiving the regulating signal from ERCOT or on detection of deviation of frequency greater than 0.09Hz, the aggregator sends commands to the appropriate relays that then sent signals to the charger contactors to either open or close the contactors, thus either connecting or disconnecting the EV charger. The following parameters have been defined for this purpose,

- Deploy or deployment: turning off the EV chargers
- Undeploy or undeployment: turning on the EV chargers

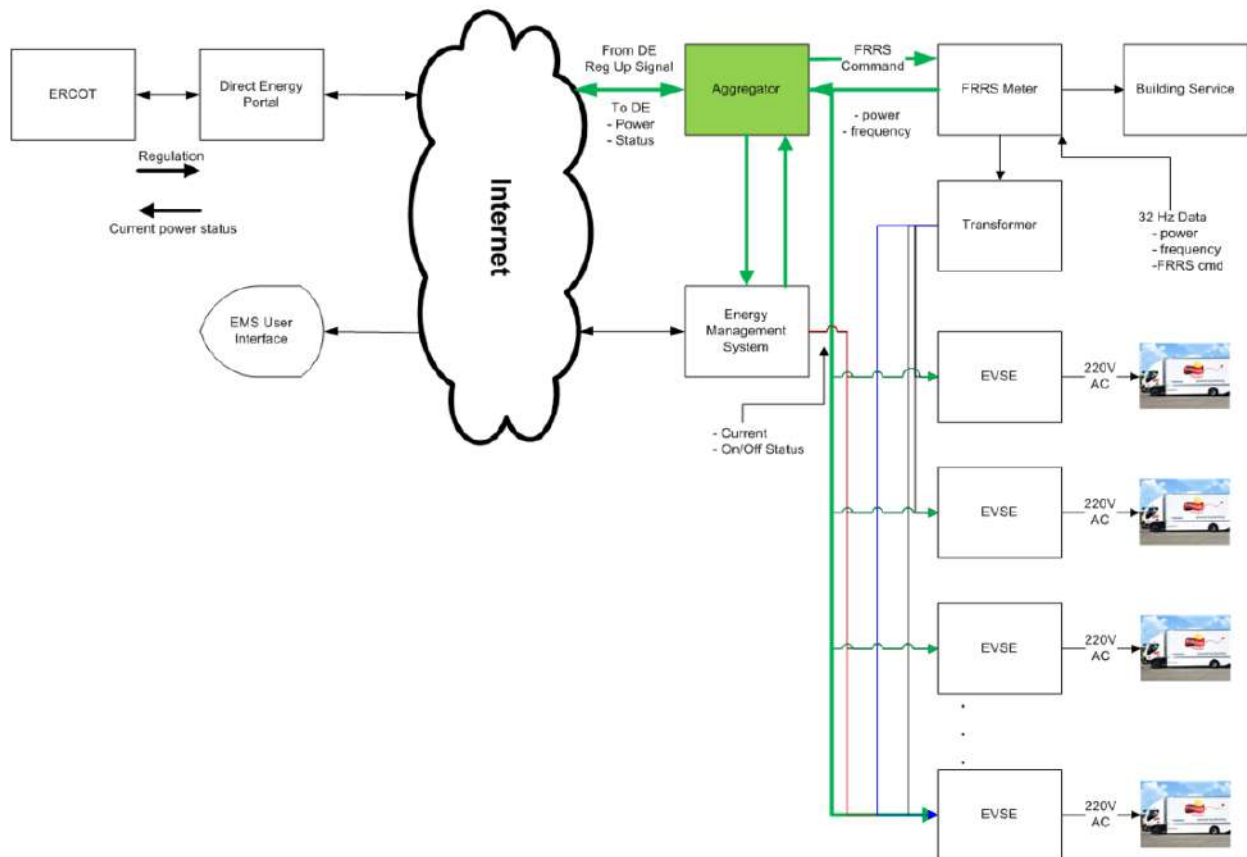

Figure 3.16: Architecture of pilot for provision of FRRS from EV fleet in Frito-Lay facility standby (CCET, 2015)

The control logic for switching the EVs ON/OFF was implemented in the aggregation system. The sequence of the decisions made by the aggregator were:

- Determine if the current system time was within the bid hour
- Determine if the system was currently in the deploy mode
- Make a prediction on which chargers should be turned off considering the current power readings and the amount of power bid into the market.

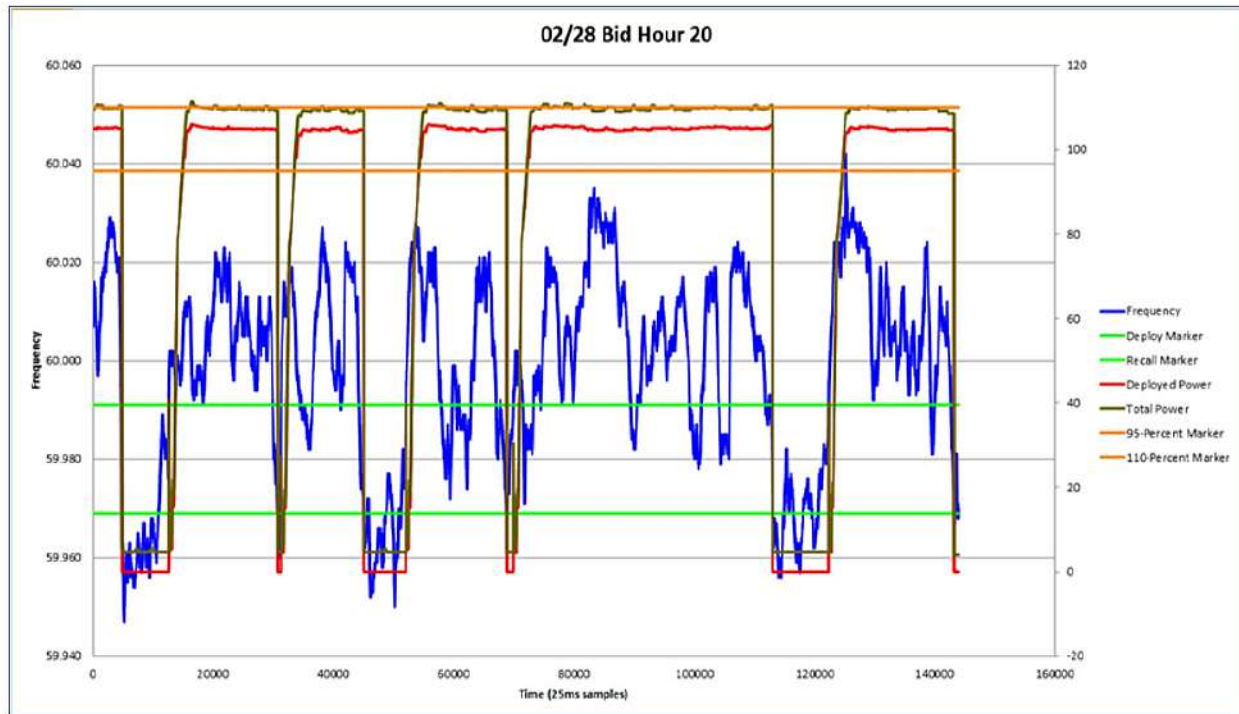

Figure 3.17: Successful FRRS deployment standby (CCET, 2015)

Economic benefit to the Fleet Owner

The prices of the frequency regulation services are changed as per grid requirement as shown in Figure 3.18. The EVs cannot participate during the morning peak because of scheduled deliveries. By scheduling the EV fleet to participate in frequency regulation during the evening peak, the fleet operator in 30 days can earn INR 19,892 (EUR 226) as given in Table 3.4.

In the current model, the operator is required to pay a fee of INR 1,48,288 (EUR 1680) per month to the Qualified Scheduling Entity (QSE) service for maintaining the communication link between ERCOT and the fleet aggregator. Although, in the current market model, it may not be economically an attractive option for the fleet operator to participate in FRRS, large scale

participation of EVs and an inclusive electricity market is likely to be an attractive option for EVs of different segments to participate in FRRS and other ancillary services.

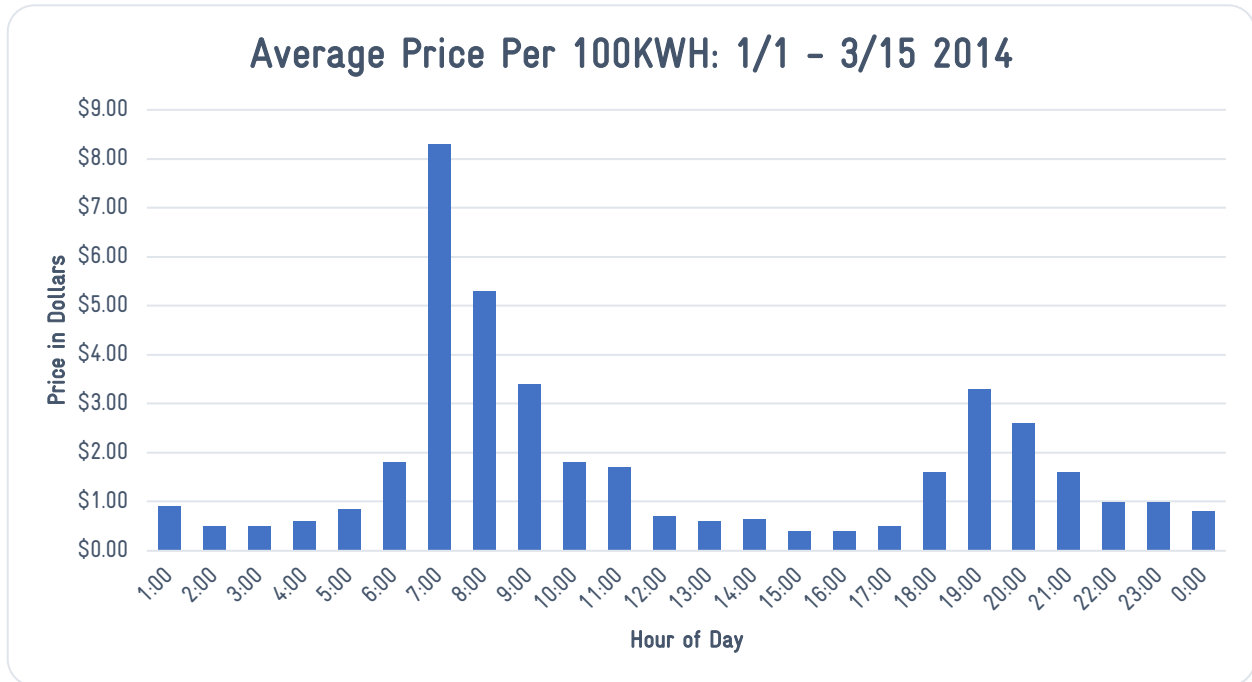

Figure 3.18: Average price for frequency regulation services per 100 kWh in 2013 standby (TECHNOLOGY SOLUTIONS FOR WIND INTEGRATION IN ERCOT, 2015)

Table 3.4: Potential revenue for participating in the 5:00pm-9:00 pm timeframe

Hour ending	Price per 100 kWh (INR/ EUR)	30 days income (INR)
6:00 pm	114.9/ 1.304	3449.92/ 39.168
7:00 pm	252.09/ 2.862	7560.47/ 85.836
9:00 pm	191.29/ 2.172	5729.11/ 65.04
9:00 pm	105.28/ 1.195	3144.45/ 35.69
	Total	19892.12/ 225.841

3.6 Case studies

3.6.1 Los Angeles Air Force Base Vehicle-to-Grid Demonstration

Project Category: Demonstration Project (Black et al., 2018)

Project Aim: Provision of ancillary service, specifically frequency regulation services to the California Independent System Operator (CAISO) using V2G capabilities of the EV fleet

Project Duration: 2012-2017

Summary: 42 of the IC engine vehicles from the non-tactical fleet of the Los Angeles Air Force Base were replaced with all-electric or plug-in hybrid electric vehicles. Of those, 29 were fitted with bi-directional capability, using which frequency regulation services could be provided to the California ISO. A total of 255 MWh of regulation up and 118 MWh of regulation down services were provided within a span of 20 months.

Each session of providing frequency regulation to the California ISO required several steps:

- travel data of vehicles
- optimal schedule generation for charging the EVs and maintain a minimum regulation bid capacity
- communicating those bids and the resulting awards and dispatches to/from the California ISO using open standard communications, and
- using an optimal hierarchical framework to control EV charging/discharging to participate in frequency regulation

The dispatch regime and other data between the on-site resource was coordinated with the scheduling coordinator which here was Southern California Edison, the aggregated remote intelligent gateway (ARIG), and the California ISO via the Distributed Network Protocol 3 (DNP3) communications protocol. Communications between On-Base Electric Vehicle Infrastructure (OB-EVI) and electric vehicle charging infrastructure used two standard data formats, Open Charge Point Protocol (OCPP) and the Smart Energy Protocol 2.0 (SEP2 or IEEE 2030.5)

Figure 3.19 shows the overall system architecture. The EVSEs were all behind a single dedicated California ISO meter with communication paths to California ISO. The California ISO meter was behind the LAAFB's single Southern California Edison (SCE) retail meter. The centralized controller communicated with the EVSEs to determine which EVs were connected, their battery SOC, collected EV reservation trip data, provided day ahead market bid schedules generated by the Distributed Energy Resources Customer Adoption Model (DER-CAM) optimizer to the

scheduling coordinator (SCE), and to the California ISO through the grid communication interface. During market participation, the controller also receives the automatic generation control (AGC) dispatch setpoints from the California ISO at around 4-5 s intervals and disaggregates each AGC setpoint into individual set points for each active EVSE/EV.

Figure 3.20 shows the set-points set by AGC signal from CAISO and the aggregate response from the EV fleet, showing the quick response time and accurate tracking.

Learnings:

- The project successfully demonstrated the provision of frequency regulation services to the CAISO network using the V2G capabilities of its EV fleet.
- By providing frequency regulation services, the EV fleet was able to earn a revenue of INR 3,74,872 (EUR 4256.04)/month.

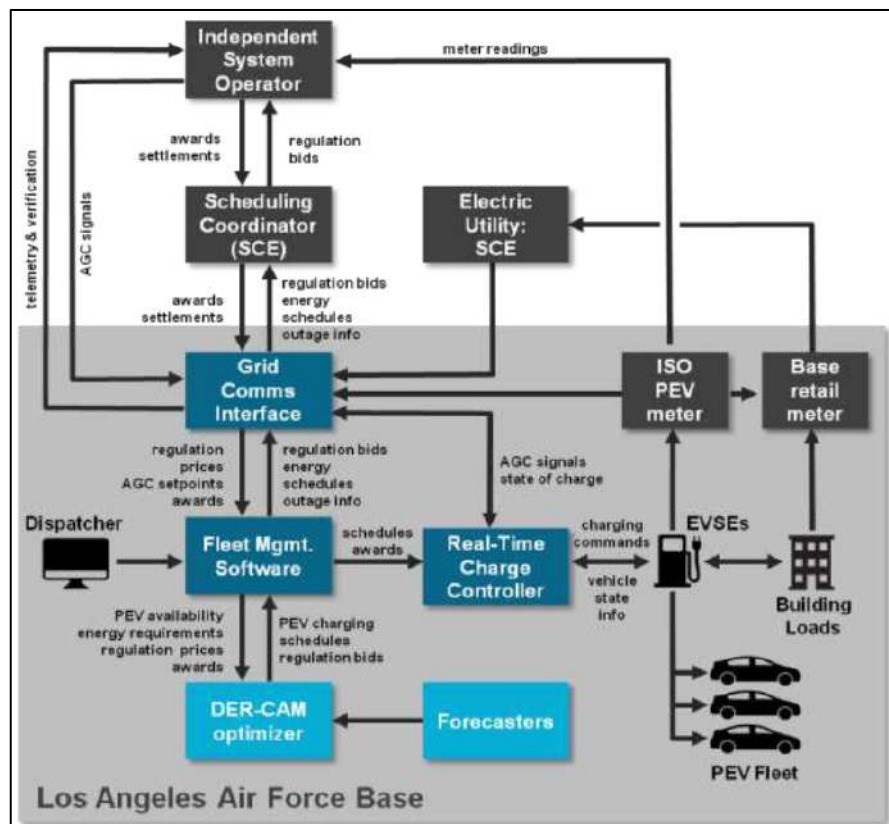

Figure 3.19: Schematic of the Los Angeles Air Force Base Vehicle to Grid Project (Black et al., 2018)

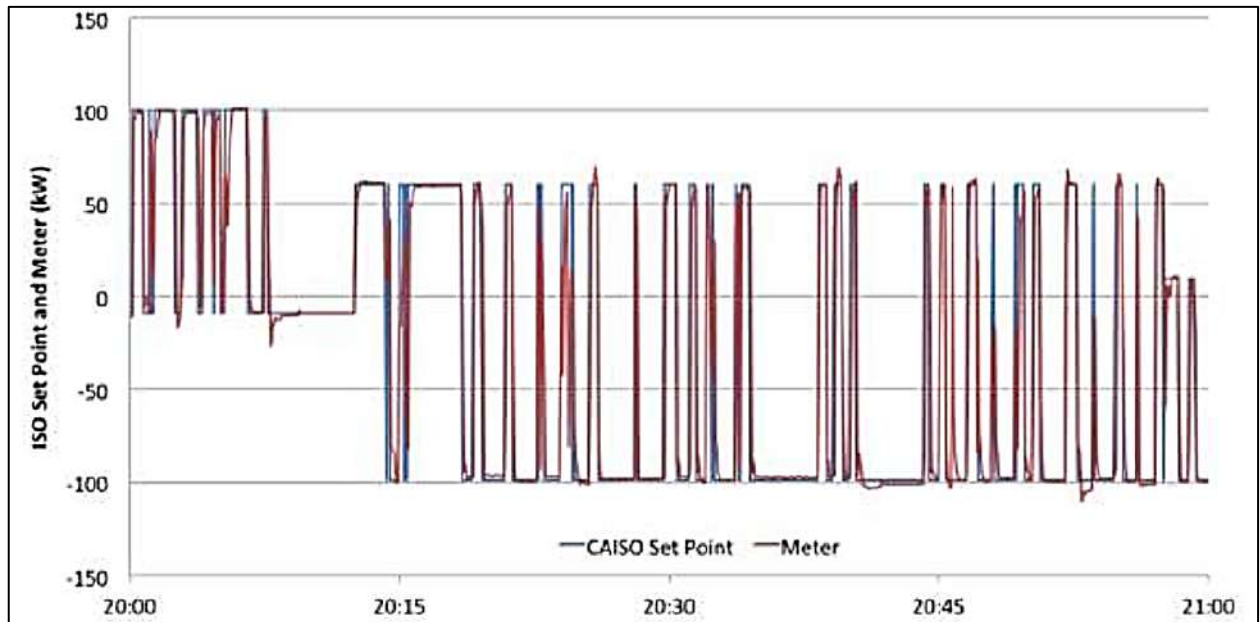

Figure 3.20: CAISO AGC Dispatch Setpoint and aggregate EV meter shown over a period of 1 hour (Black et al. 2018)

3.6.2 JUMPSmartMaui (JSM)

Project Category: Demonstration Project (Project Lead: Hitachi) (EPRI, 2016; Irie, 2017)

Project Aim:

Objectives and aims of Phase 1

- Increase the utilization of renewable energy
- Energy control via an autonomous, decentralized system using a micro-distribution management system (DMS) and an advanced inverter.
- Direct load control for grid stabilization and balancing

Phase 2

- Potential of Vehicle to Grid/Home services
- Distributed energy resources for grid services
- Higher penetration of renewables by aggregating Demand Energy Response
- Aggregation and Control of DER as a Virtual Power Plant

Project Duration: 2012-2016

Summary: In the project, Nissan Leaf EVs were deployed along with 80 6kW Hitachi DC chargers with V2H functionality. EV energy control center was able to shift the peak charging time. The micro DMS and the advanced inverter were able to stabilize the voltage. Further, utilizing data visualizing enabled the operators and Maui Electric Company to

- Detect over or under frequency and voltage at the whole island and control the distributed energy resources accordingly
- Minimize the impact and achieve restoration when there is a distribution network fault or overload condition

An Integrated Distribution Management System (DMS) performs the management of EVs considering the support of the power system. Various equipment and systems such as electric vehicles and charging stations, water heaters, bulk energy storage, static VAR compensators (SVCs), medium voltage section switches and other peripheral devices were equipped with control features. The integrated DMS developed the operational plan for the entire system in collaboration with other management systems. For controlling the components downstream of the pole-mounted transformers, a low voltage management system micro DMS (μ -DMS) has been utilized. The μ -DMS is installed for each pole-mounted transformer connected to users participating in the project. The integrated DMS utilized these μ -DMS to create a charging schedule to fill the gap based on estimated renewable generation as well as the forecasted load. Considering each EV connection status to the charger and the desired end time of charge, the start time of the charge is passed on to the EV. The overall system architecture is shown in Figure 3.21. The users participating in the program are given access to a web portal, shown in Figure 3.22, through which they can configure their requirements.

Learnings:

- The peak load reduction and frequency support from EVs were demonstrated.
- The fast response time of EVs was found to be very helpful for grid support services

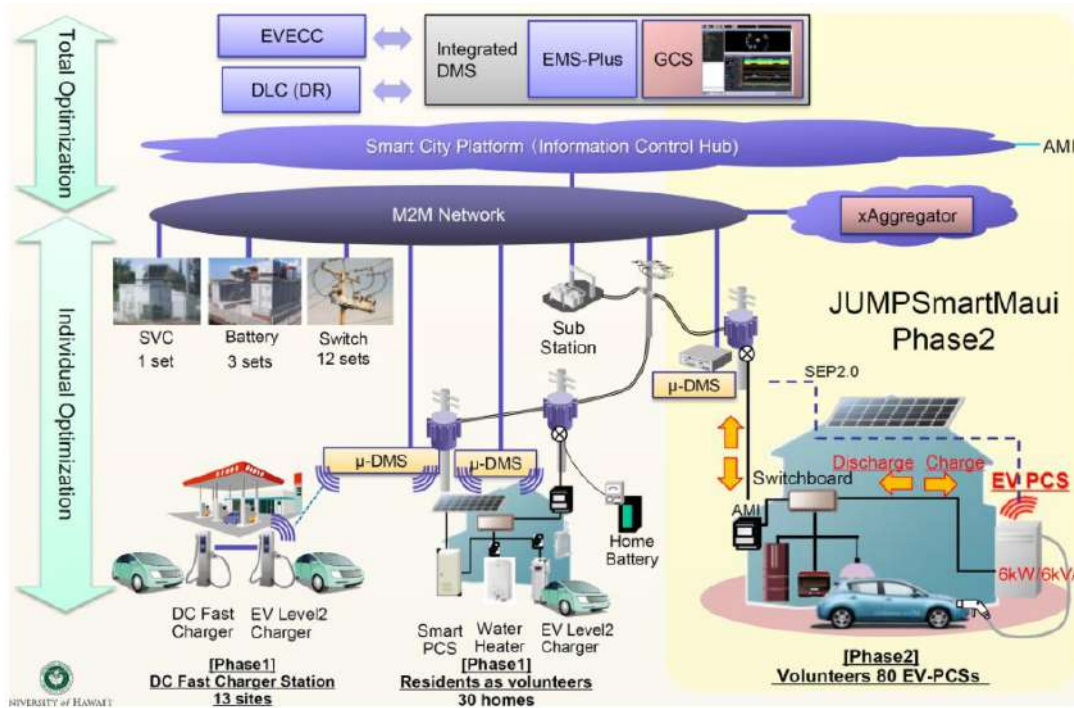

Figure 3.21: Overall system architecture of JUMPSmartMaui(Irie, 2017)

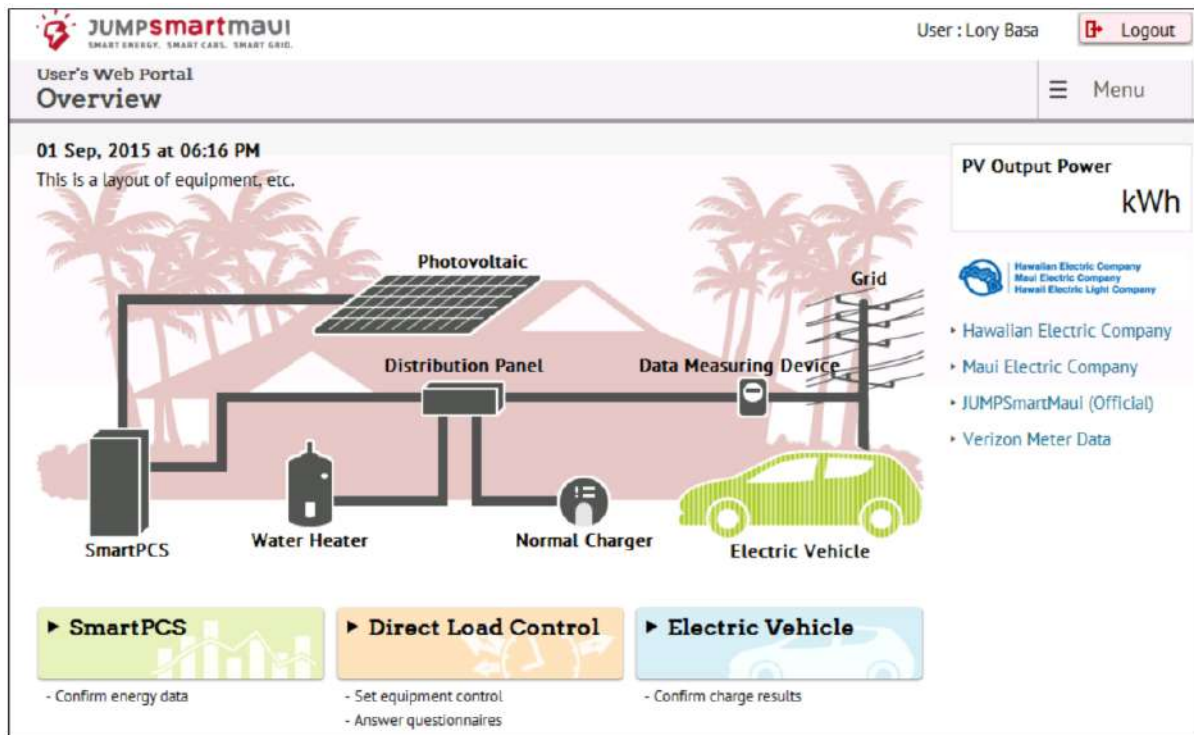

Figure 3.22: Web portals for participants (EPRI, 2016)

3.6.3 Smart Charging of EV and Storage supporting the Grid

Project Category: Demonstration Project

Project Aim: The project was designed to develop and demonstrate charging infrastructure, including both software and hardware, for

- smart charging,
- V2G,
- V2B,
- grid services like load levelling, RE integration, demand response
- and cost recovery

Summary: The project was a four phased project with different goals for each phase. The first phase of the project consisted of research on relevant smart charging technologies and building a smart charging architecture (Gadh, 2018). In the second phase the prototype smart charging and energy management systems were developed and tested at the University of California, Los Angeles (UCLA) testing sites. The first and second phase results were used to implement experiments on installed hardware and software in the third phase. In the fourth phase, a demonstration in the City of Santa Monica was conducted, which included implementation of curtailment of different load, load shifting, V2G, V2B operation, and other smart charging algorithms.

Implementation of Smart Charging:

For bidirectional support from the PEVs, CHAdeMO protocol has been used. The system monitoring has been accomplished using a power meter that provides the power/energy data at a 1-minute sampling rate and the data is communicated with the control center through TCP/IP protocol and HTTP POST method. The data is first stored in a MySQL database and then pulled by a web application/app for presentation on the central control center or on the mobile apps. The communication of control functions given by the user is achieved via the mobile app. The signals are sent through TCP/IP to a router which uses port forwarding to locate a Raspberry PI, which contains a python script that controls the system.

The DR events are received from the cloud based Super Control Centre (SCC). The SCC communicates with the EV Control Centre through ethernet, while the EV Control Centre communicates with each individual Communication Gateway (CG) through either ethernet, 3G/4G, or Wi-Fi. The CG communicates with each individual EV charging station as shown in Figure 3.23.

The IEC 61850 Gateway and Client communicate with each other via the Manufacturing Message Specification (MMS) protocol that is mandated by IEC 61850. All the communications between the control center, mobile app and EVSE are standardized by IEC 61850 given in Figure 3.24. In the implementation of this project, Zigbee protocol was used between smart meters and the communication gateway inside the EVSE, and Powerline Communication (PLC) is used for communication between EVSE and the connected EVs.

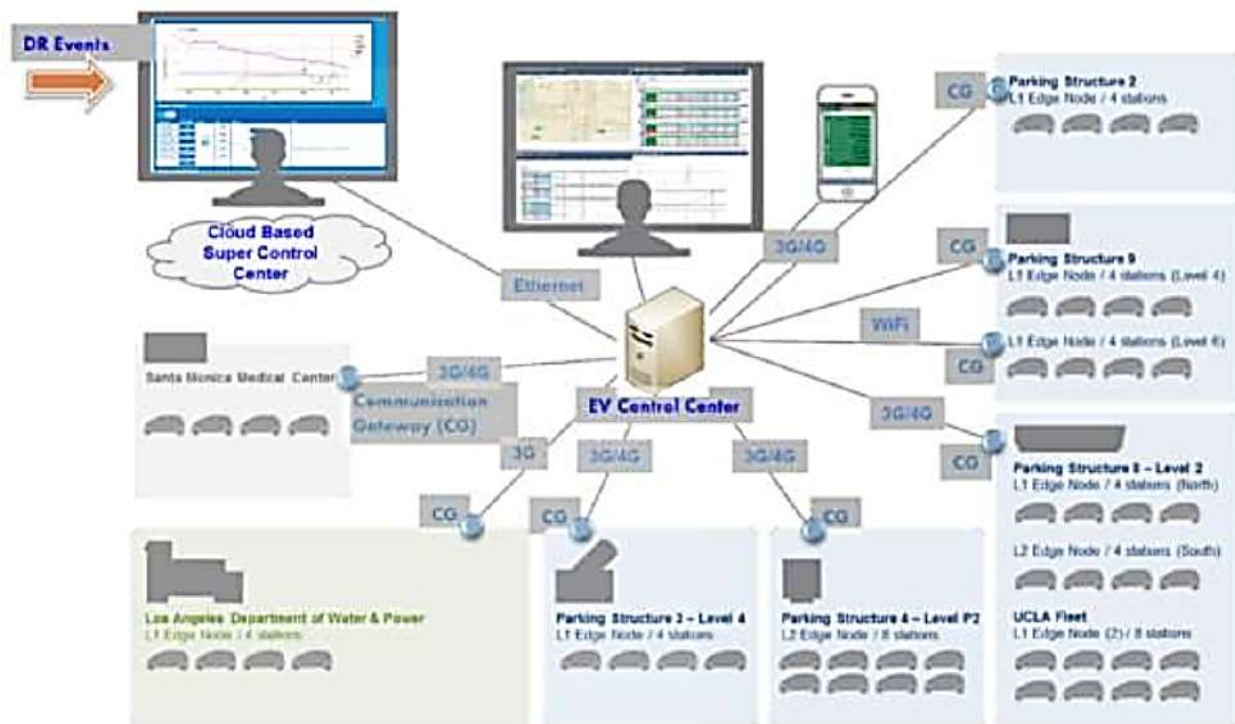

Figure 3.23: EV Communication Network (Gadh, 2018)

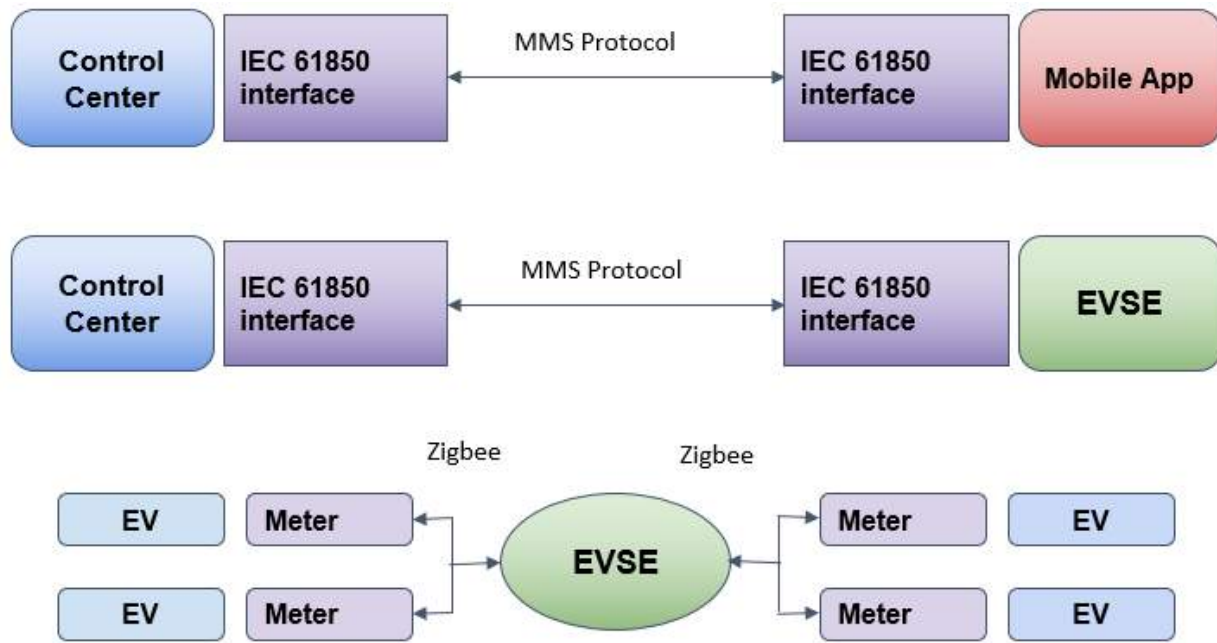

Figure 3.24: Smart Charging infrastructure with IEC 61850 standard (Gadh, 2018)

For the field verification a total of 117 plug points were considered which included both Type 1 and standard 3 pin sockets, 2 Fast DC chargers following the CHAdeMO protocol, 135.2 kW of PV and 128.5 kWh of BESS had been used. Only the CHAdeMO chargers were configured to provide bidirectional power when a Nissan Leaf EV is charging.

THE UCLA Engineering IV building load profile for a particular day has been chosen as the baseload for the V2B control algorithm. The baseload had a consumption peak from time slot No 17 to time slot No 27, and valley from time slot No. 33 to No. 50. The smart charging algorithm used, controls the charging rate of each EV to reduce the peak as well as fill the valleys as illustrated in Figure 3.25.

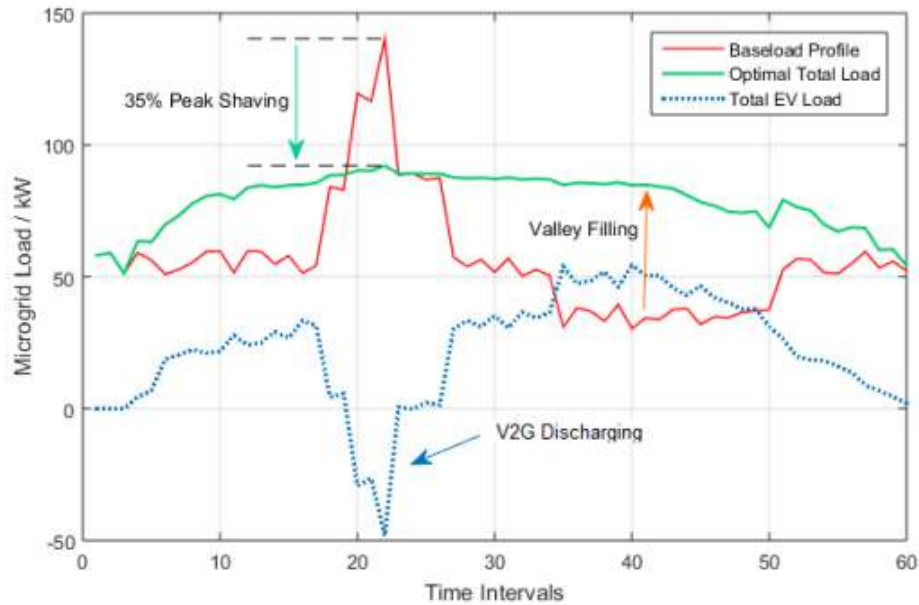

Figure 3.25: Flattening of Baseload by V2B scheduling (Gadh, 2018)

Smart charging strategy has also been used to mitigate the duck curve due to high solar PV generation as can be observed in Figure 3.26. By shifting the EV charging load to the peak PV generation period, the duck curve can be mitigated to a high extent.

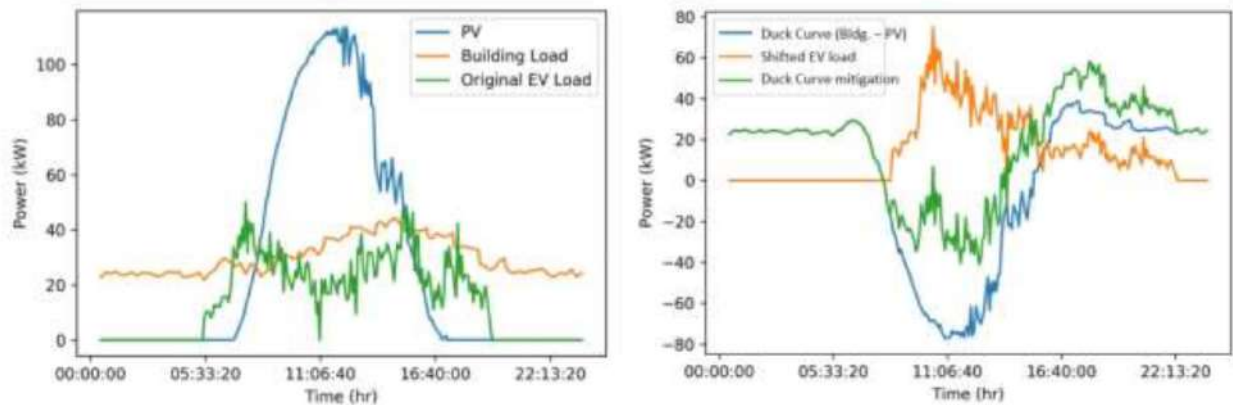

Figure 3.26: Mitigation of duck curve caused due to high PV generation in building load using Smart Charging (Gadh, 2018)

Learnings:

- Due to lack of standards, V2G implementation was found to be complex. The additional work that the team had to do was due to defining communication and control interfaces at multiple levels.
- V1G technology and its implementation for demand response in a microgrid was found to be stable and mature.

- The cost of integration, commissioning, and installation of batteries with inverters is expensive and therefore as V2G becomes standardized with an open architecture it is going to be more economically viable.

3.6.4 Use of Electric Vehicle to reduce customer outages (improve reliability) and provide emergency backup power

Project Category: Demonstration Project (PG&E, 2016b)

Project Aim: The primary objective of this project was to develop and demonstrate a Vehicle On-site Grid Support System (VOGSS) from fleet trucks to a distribution circuit or independent load for:



- Increasing reliability of a local grid circuit
- Providing unplanned outage relief and resiliency.

Summary: This project was designed to utilize the Plug-in Hybrid Electric Vehicle fleet trucks to provide an on-site back up power supply. The onboard technology of PHEV trucks includes a generator set as well as an ICE engine. For the application of Vehicle On-site Grid Support System (VOGSS), power is transmitted from the PHEV to the grid, either from the battery or by running the PHEV engine, based on the power requirement. This approach is more efficient as unlike a diesel generator set, the engine is run at the most efficient operating point.

The VOGSS technology was engineered as a durable, high reliability electric transmission. It is a 4 mode, series-parallel PHEV drivetrain that integrates two electric motors. The designed system can achieve output voltages of

- 240 V AC single phase
- 208 V AC three phase
- 240 V AC three phase
- 480 V AC three phase

And it meets power utility standards

- IEEE 519 and IEEE 1547
- UL listed inverter UL 1741

The mode of operation

- **'Island mode'- Grid forming.** In this mode the PHEV with its export power serves as a replacement for the grid connection. It is used in emergency situations when there is no grid present or in remote off-grid locations.
- **'Grid synchronized mode' – Grid following.** In this mode the PHEV is connected parallel to the utility grid. Once the PHEV picks up 100% of the local load, the utility grid may be disconnected without the downstream load seeing any disruption. This functionality finds its use mainly for hot swapping of transformers.

The VOGSS enables the vehicle to export power for utility power requirements, and also for consumer or commercial power applications. Depending on the maximum power that the vehicle can provide they are categorized into a class system. The maximum power of 160 kVA was chosen as a practical trade-off between the lowest cost and the number of transformers with less capacity than the maximum power of the vehicle, so that the transformer can be served in emergency scenario by the vehicle. The distribution of transformers in the PG&E system based on their rated capacities is given in Figure 3.27.

Vehicle Class	Peak Power (continuous)
3	75 kVA
5	120 kVA
6	160 kVA

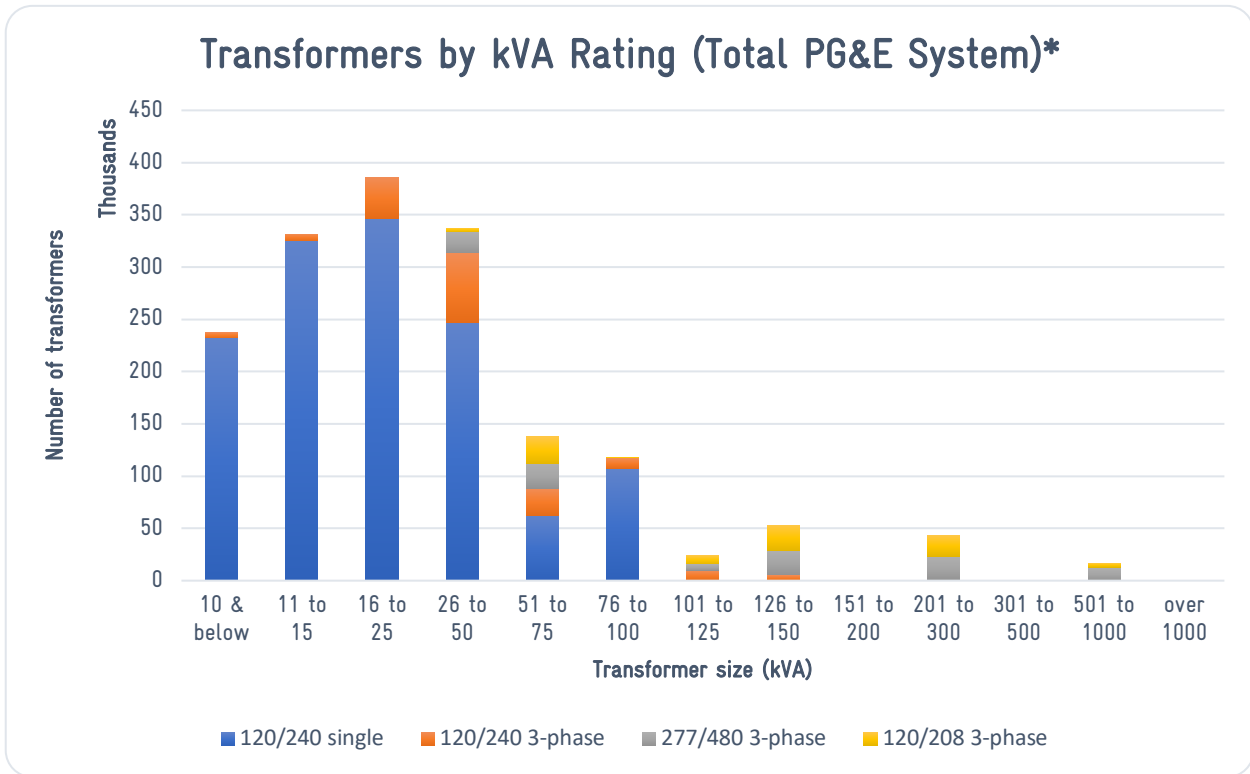
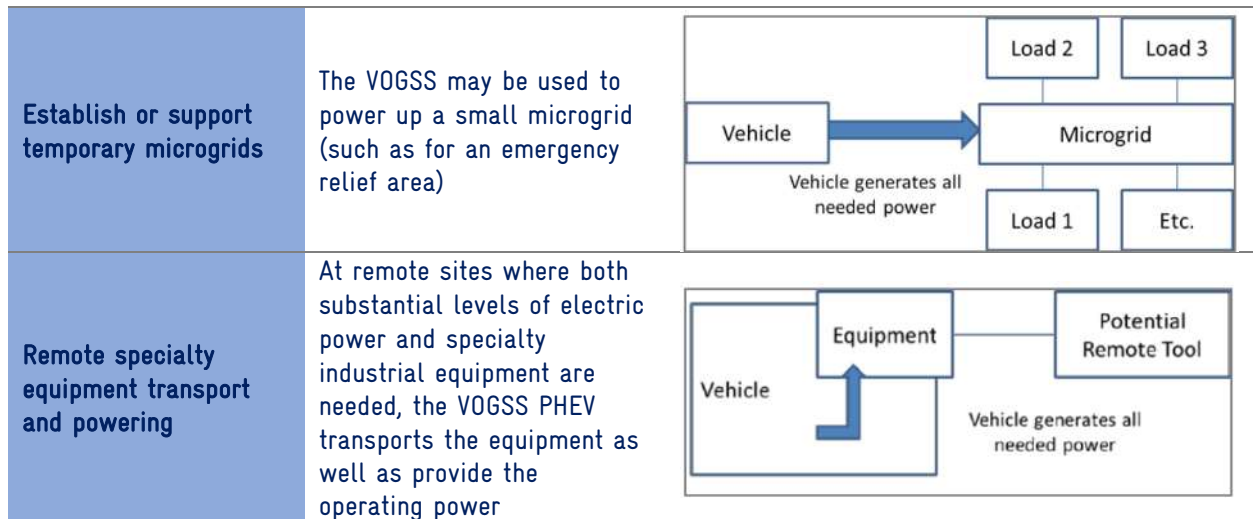

Figure 3.27: PG&E System transformer as per their kVA ratings (PG&E, 2016b)

The different use cases for the VOGSS have been summarized in Table 3.5

Table 3.5: Use case of VOGSS equipped PHEV

Use case	Description	Connection diagram
Transformer replacement	VOGSS equipped PHEV connects to the grid and picks up the load connected to the secondary of the transformer before disconnecting the grid.	
EV charging	At remote off-grid location or during special events, where it is not convenient/impossible to import power from the grid, the VOGSS provides temporary power to an electrical vehicle or to a charging station	



The provision of this extra power although did put a stress on the inverter of the PHEV which led to significant rise in the inverter temperature (shown in Figure 3.28) due to which auxiliary cooling solutions were needed to keep the operating temperatures under the rated values.

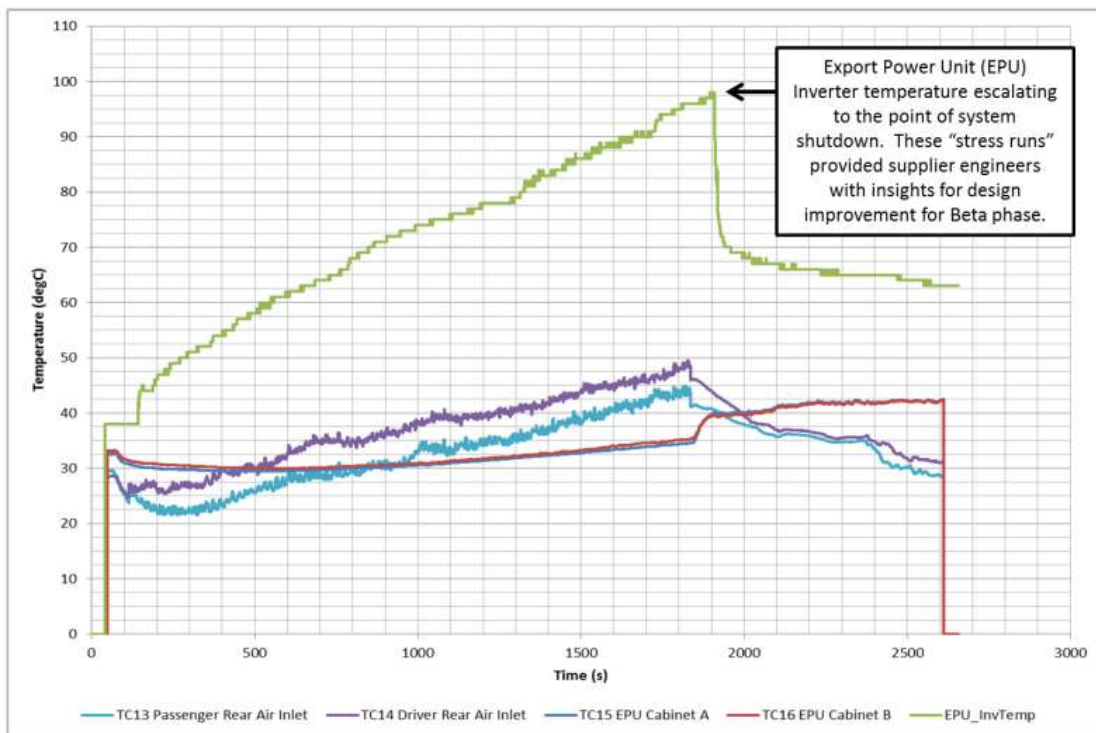

Figure 3.28: Temperature measurements during power export (PG&E, 2016b)

Learnings:

- Thermal management is one of the critical issues experienced in developing the VOGSS system.

- The use of VOGSS was a successful demonstration of mobile power units that can help deliver power for emergency power supply. It had been successfully used in relief shelters during the 2015 California wildfires.

3.6.5 Detailed analysis of DC Fast Charging

EV Model: Ford Mustang Mach-E First Edition

Connector in Model: CCS Type 1

Charging Power:

- 150kW peak DC power
- 12 kW AC power

Battery Capacity: 99kWh installed capacity

Charging station: 350kW DC charger of Electrify America Charging Station in Lakewood, Colorado

In this case study a Ford Mustang Mach-E first Edition is charged from 0% SOC to 100% SOC which took 2 hours and 32 minutes (Kane, 2021). The charging power changes as per the current SOC of the battery as shown in Figure 3.29. Initially when the vehicle is plugged in, the EV charges at a peak power of 159kW, however, as the EV battery achieves 7-10% SOC, the charging power drops down to 112 kW, followed by 106-107 kW at SOC of 11-27%. The next level down is when the vehicle charges at 95-97 kW at 31-37% SOC and then the charging stabilizes at 76-80 kW till the 80% SOC. Beyond 80%, the charging power takes a huge drop to only 12 kW.

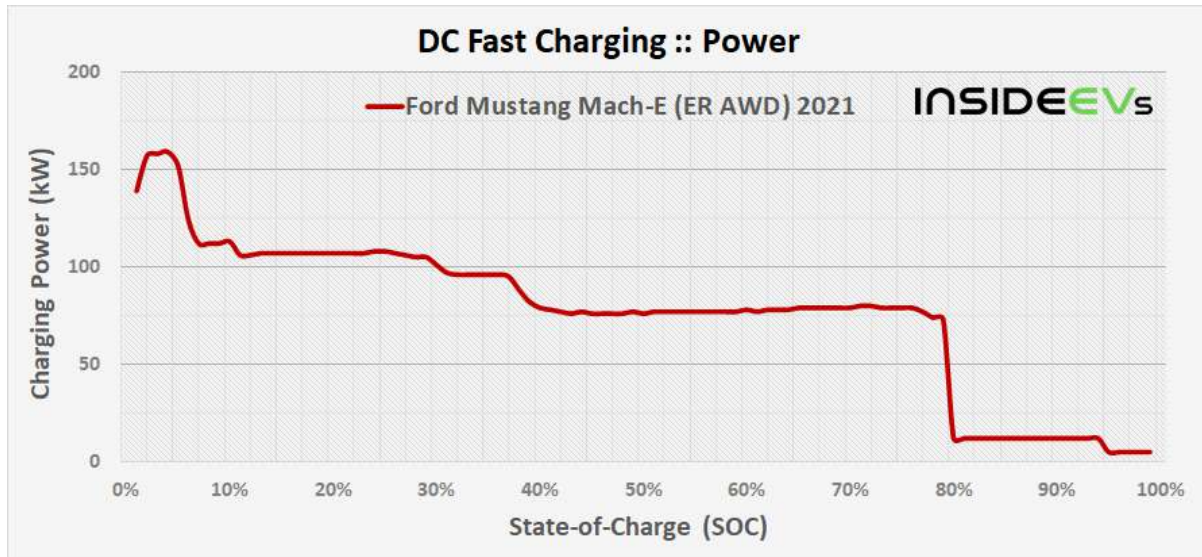

Figure 3.29: Variation of charging power with SOC (Kane, 2021)

Taking a look at the SOC of the vehicle with time, shown in Figure 3.30, it can be seen that the charging from 20% to 80% SOC took about 42 min.

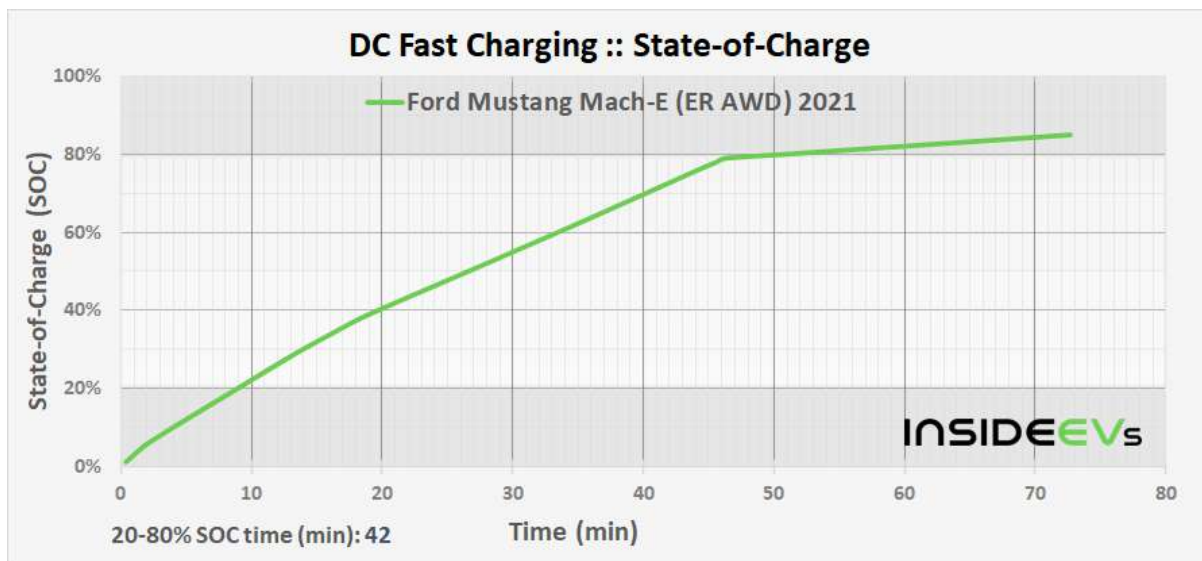

Figure 3.30: Change in SOC of vehicle while charging (Kane, 2021)

Therefore, as the charging power is variable with SOC levels, it is important to calculate the average charging speeds for different combinations of starting and final SOC levels which is shown in Figure 3.31. As can be seen for a short burst of charging at extremely low SOC values (1-5%) the EV charges at the rated 150 kW charging speed. But if the charging starts from 1% SOC and charges up to 80% SOC the average charging power decreases to 90 kW. Thus, it can be concluded that as the charging window moves to higher SOC levels the average charging power decreases.

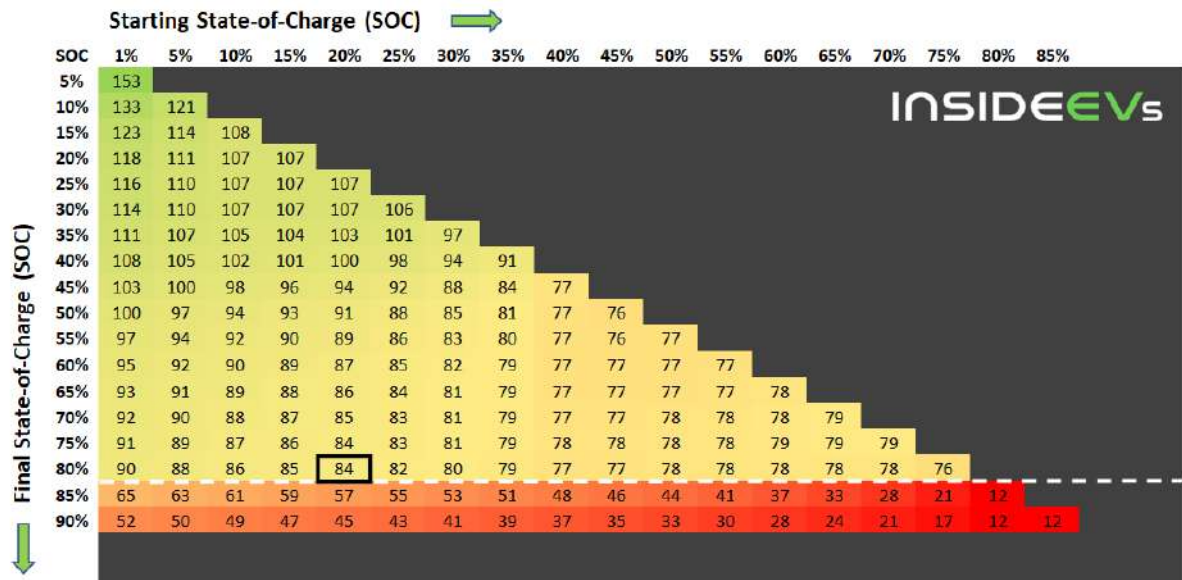

Figure 3.31: Average charging power in the SOC window (Kane, 2021)

Charging rate (C-rate) relates the charging power to the battery capacity. For example, 1C equates to the charging power (current) that would charge the entire battery capacity in 1 hr. Similarly, 2C would charge the battery in 0.5 hrs. and 0.5C would charge the battery in 2 hrs. As shown in figure below, at low SOC the battery charges at peak 1.61C, but the average C-rate when charging from 20% to 80% SOC is 0.85C.

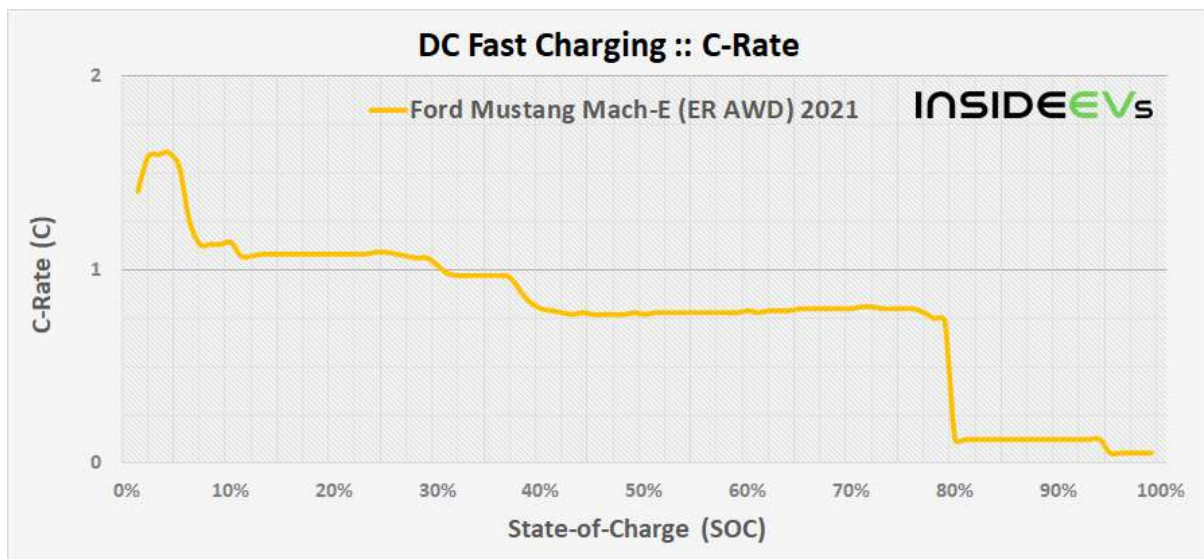

Figure 3.32: Variation of C-rate with SOC for DC fast charging (Kane, 2021)

This charging speed is however specific to the EV model. Therefore, a comparison has been made between the charging speeds of the Ford Mustang Mach-E First Edition with the Volkswagen ID.4. As can be seen in the Figure 3.33, although the Volkswagen has a lower peak of 128 kW, it sustains the peak for a longer duration. The average charging power for 20-80% charging for the Volkswagen is 91 kW as compared to the 84 kW for the Ford Mustang. The Volkswagen also took only 31 mins for 20-80% charging compared to 42 mins for the Ford Figure 3.34.

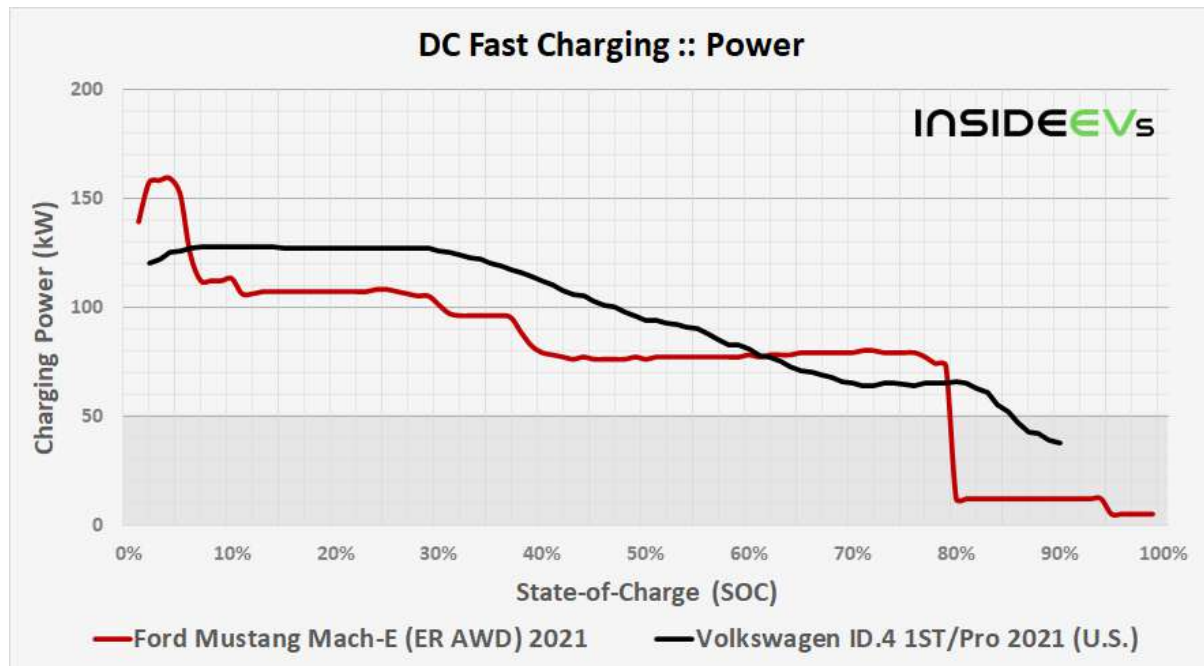

Figure 3.33: Comparison of variation of charging power with SOC for Ford Mustang Mach-E and Volkswagen ID.4 (Kane, 2021)

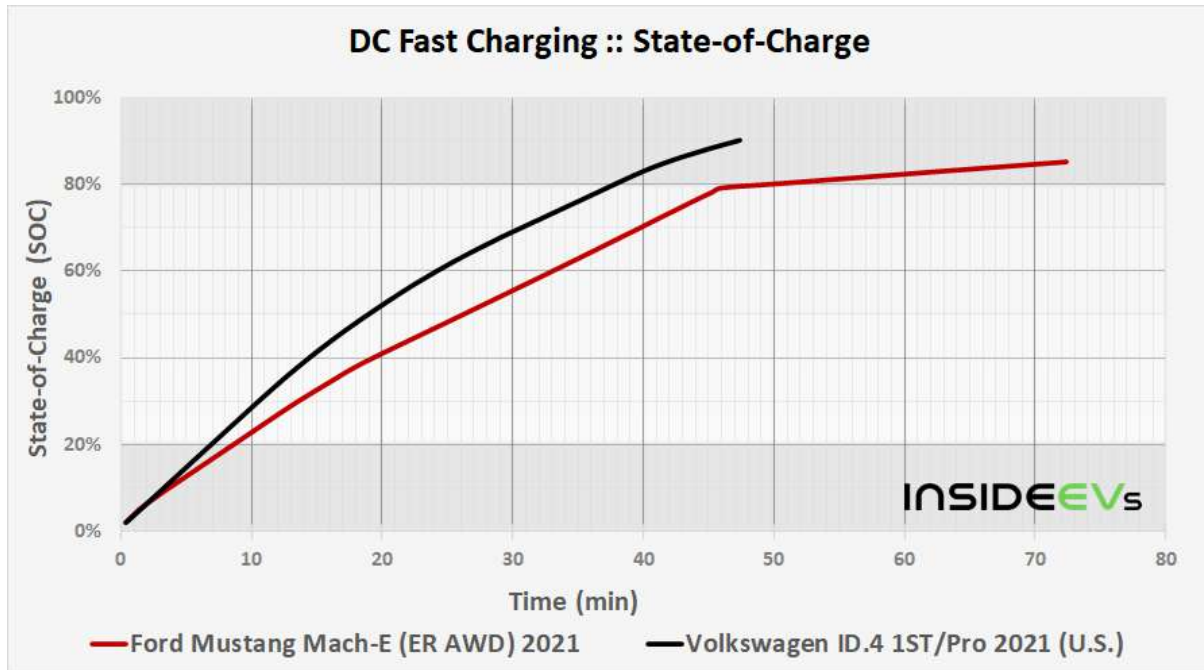

Figure 3.34: Comparison of SOC for Ford Mustang Mach-E and Volkswagen ID.4 (Kane, 2021)

Chapter 4. California, USA

4.1 Background for EV policies

California has the largest economy in the USA and if considered as an independent country, it would have the 5th largest economy in the world. It also has ambitious goals for sustainable energy, which has translated to it aggressively promoting the transition of the transportation section from conventional fuel based to electricity based. Active support for EV has made California the leader of EV among the different states of U.S. In addition to the federal incentives for the purchase of EV, California offers purchase rebates to plug-in electric vehicles through its Clean Vehicle Rebate Project (CVRP) scheme. Initially, the CVRP provided rebates up to INR 3.7 lakh (EUR 4214) per light-duty vehicle in addition to the INR 5.56 lakh (EUR 6321) federal tax credit, which was later brought down to INR 1.85 lakh (EUR 2107) per vehicle after the initially allocated funds were exhausted. Moreover, zero emission vehicles (ZEV) are provided access to California's carpool and high-occupancy vehicle lanes. This access to fast lanes had a significant impact on the sales of plug-in vehicles.

4.2 EV Charging infrastructure policies and regulations

Table 4.1: EV charging infrastructure policies for the state of California, USA (*Laws and Incentives*, n.d.)

Policies Enabling EV charging on supply-side		
Element	Policy Instrument	Measures
Definition of a fundamental market design framework to limit distortions and entry barriers	Plug-In Electric Vehicle (PEV) Charging Access California Government Code 65850.9	<ul style="list-style-type: none"> There is no restriction on the use of a public EV charging stations that has been funded in any part by state or utility, for use by any type of PEV.
	Electric Vehicle Supply Equipment (EVSE) Signage Authorization on Highways California Streets and Highway Code 101.7	EVSE facilities located at roadside businesses are eligible to be included on state highway exit information signs. Signage must be consistent with California's Manual on Uniform Traffic Control Devices.
	Zero Emission vehicle (ZEV) and Infrastructure Support	Under this mandate, the California Energy Resources Conservation and Development Commission is required to provide assistance and support for the increased utilization of zero emission fuel vehicles, fuelling infrastructure and fuel transportation technologies

	<p>Electric Vehicle Supply Equipment (EVSE) Pilot Programs California Public Utilities Code 740.13-740.14</p>	<p>The California Public Utilities Commission (PUC) may provide funding for pilot utility programs to install EVSE at school facilities, other educational institutions, and state parks or beaches. Priority must be given to locations in disadvantaged communities, as defined by the California Environmental Protection Agency.</p>											
<p>The incentive for launching the EV charging market</p>	<p>Plug-In Electric Vehicle (PEV) Charging Rate Reduction - LADWP</p>	<p>The Los Angeles Department of Water and Power (LADWP) offers INR 1.85 (EUR 0.02) per kilowatt-hour discount for electricity used to charge PEVs during off-peak times. Residential customers who install a separate time-of-use meter panel will also receive INR 18536 (EUR 210) credit.</p>											
	<p>Electric Vehicle Supply Equipment (EVSE) Rebate - LADWP</p>	<p>The Los Angeles Department of Water and Power (LADWP) provides rebates to commercial customers toward the purchase of Level 2 or direct current (DC) fast EVSE. Commercial customers who purchase and install EVSE for employee and public use can receive up to INR 3,70,720 (EUR 4210) for each Level 2 EVSE with up to INR 37072 (EUR 421) in additional rebate funds per extra charge port. Commercial customers may also receive up to INR 55,60,807 (EUR 63 thousand) per DC fast EVSE, and up to INR 92,68,012 (EUR 0.105 million) per DC fast EVSE for medium- and heavy-duty vehicle use.</p>											
	<p>Electric Vehicle Supply Equipment (EVSE) Rebate - Sacramento County</p>	<p>The Sacramento County Incentive Project, funded by the California Energy Commission as part of the California Electric Vehicle Infrastructure Project (CALeVIP), offers rebates in the following amounts for installations at new, replacement, or make-ready sites</p> <table border="1" data-bbox="743 1325 1406 1822"> <thead> <tr> <th data-bbox="743 1325 938 1478">Project Type</th> <th data-bbox="938 1325 1182 1478">Maximum Rebate- in disadvantaged communities</th> <th data-bbox="1182 1325 1406 1478">Maximum rebate - outside disadvantaged communities</th> </tr> </thead> <tbody> <tr> <td data-bbox="743 1478 938 1631">Fast DC</td> <td data-bbox="938 1478 1182 1631">80% of total cost up to INR 59,31,528 (EUR 67,342)</td> <td data-bbox="1182 1478 1406 1631">75% of total project cost up to INR 51,90,087 (EUR 58,924)</td> </tr> <tr> <td data-bbox="743 1631 938 1709">Level 2 EVSE</td> <td data-bbox="938 1631 1182 1709">INR 4,07,792 (EUR 4629.79)</td> <td data-bbox="1182 1631 1406 1709">INR 3,70,720 (EUR 4208.9)</td> </tr> <tr> <td data-bbox="743 1709 938 1822">Level 2 EVSE (multi-unit dwelling)</td> <td data-bbox="938 1709 1182 1822">INR 4,81,936 (EUR 5471.57)</td> <td data-bbox="1182 1709 1406 1822">INR 4,44,864 (EUR 5050.681)</td> </tr> </tbody> </table>	Project Type	Maximum Rebate- in disadvantaged communities	Maximum rebate - outside disadvantaged communities	Fast DC	80% of total cost up to INR 59,31,528 (EUR 67,342)	75% of total project cost up to INR 51,90,087 (EUR 58,924)	Level 2 EVSE	INR 4,07,792 (EUR 4629.79)	INR 3,70,720 (EUR 4208.9)	Level 2 EVSE (multi-unit dwelling)	INR 4,81,936 (EUR 5471.57)
Project Type	Maximum Rebate- in disadvantaged communities	Maximum rebate - outside disadvantaged communities											
Fast DC	80% of total cost up to INR 59,31,528 (EUR 67,342)	75% of total project cost up to INR 51,90,087 (EUR 58,924)											
Level 2 EVSE	INR 4,07,792 (EUR 4629.79)	INR 3,70,720 (EUR 4208.9)											
Level 2 EVSE (multi-unit dwelling)	INR 4,81,936 (EUR 5471.57)	INR 4,44,864 (EUR 5050.681)											

	Electric Vehicle Supply Equipment (EVSE) Incentives for Commercial Customers - PG&E	Pacific Gas & Electric's (PG&E) EV Fast Charge Program offers competitive incentives to facilitate the installation of direct current (DC) fast EVSE from an approved EVSE list.								
	Electric Vehicle Supply Equipment (EVSE) Incentives for Medium- and Heavy-Duty Fleets - PG&E	<p>Pacific Gas & Electric's (PG&E) EV Fleet Program offers competitive incentives to facilitate the installation of EVSE for medium- and heavy-duty vehicle fleets. PG&E offers dedicated electrical infrastructure design and construction services and reduced costs for electrical infrastructure work.</p> <table border="1"> <thead> <tr> <th><i>EVSE Power</i></th> <th><i>Rebate Amount</i></th> </tr> </thead> <tbody> <tr> <td>Up to 50kW</td> <td>Up to INR 11,12,161 (EUR 12,626)</td> </tr> <tr> <td>50.1 kW to 150 kW</td> <td>Up to INR 18,53,602 (EUR 21,044)</td> </tr> <tr> <td>150.1 kW and above</td> <td>Up to INR 31,14,052 (EUR 35,354)</td> </tr> </tbody> </table>	<i>EVSE Power</i>	<i>Rebate Amount</i>	Up to 50kW	Up to INR 11,12,161 (EUR 12,626)	50.1 kW to 150 kW	Up to INR 18,53,602 (EUR 21,044)	150.1 kW and above	Up to INR 31,14,052 (EUR 35,354)
<i>EVSE Power</i>	<i>Rebate Amount</i>									
Up to 50kW	Up to INR 11,12,161 (EUR 12,626)									
50.1 kW to 150 kW	Up to INR 18,53,602 (EUR 21,044)									
150.1 kW and above	Up to INR 31,14,052 (EUR 35,354)									
Prioritisation in terms of EV characteristics and social geography	Plug-in Electric Vehicle (PEV) Parking Space Regulation California Vehicle Code 22511	The California Public Utilities Commission (PUC) is mandated to provide funding for programs to install EV charging units at different locations such as school facilities, educational institutes, state parks and recreational areas etc. Disadvantageous communities will be given a priority.								
Policies Enabling EV charging on demand-side										
Element	Policy Instrument	Measures								
The mandate for the development of digital platforms and database management systems	Electric Vehicle Supply Equipment (EVSE) Billing Requirements California Code of Regulations, Title 4, Section 4001 and 4002.11	EVSE charging rates must be based on a price per megajoule or kilowatt-hour. All EVSE must be able to indicate the billing rate at any point during a transaction.								
Specification of the use of a wide range of payment methods	Electric Vehicle Supply Equipment (EVSE) Open Access Requirements	A subscription fee or membership must not be mandated by EVSE service providers for EV users to charge their vehicles at any charging stations. The EVSE service providers are also required to disclose the actual prices for using EVSE and at least two alternate modes of payments should be available.								

Specification of minimum facilities to be provided at charging stations	California CalGreen Code	Residential buildings with over 17 units to have a minimum of 3% of all parking spaces ready for future installation of EV chargers. The Code specifies wiring practices, labelling, EV charging space dimensions and markings and accessibility. (Hove & Sandalow, 2019)
---	--------------------------	---

California is one of the proactive states when it comes to the establishment of EV charging infrastructure. On the supply side, the government has established roadmaps to encouraging charging points across social geographies, with a particular focus on harmonizing charging for intra-state mobility across highways. Different incentive schemes are floated by the government and network operators to encourage rollout of charge points. Many major cities in the state of California are taking the lead, Los Angeles for instance offers incentives for consumer to charge their EVs at off peak hours, Sacramento has levels of incentives for different types of charge points for both old and new installations, and PG&E has incentives to encourage not just car charging points, but also for heavy duty vehicles. Other existing policies encouraging ancillary services and time of use tariff impact the utilization of the grid connected EVs. Now on the demand side, California has a specific policy in place for EV charging billing, which must give a clear breakup of the rate and in terms of payment method, the service provider needs to provide at least two options for payment. Lastly the building codes also have a provision for inclusion of EV charging points amounting to 3% of the available parking to ensure future uptake of EVs.

The California Energy Commission, in a recent report (Matt Alexander et al., 2021), has stated that the state will require around 1.2 million public and shared chargers by the year 2030 to meet the charging needs of the potential 7.5 million EVs plying on the roads at that time (Charles Morris, 2021). The EV target came from Governor Gavin Newsom's executive order, which mandates the sales of all new passenger vehicles to be zero-emission vehicles by 2035. Presently, California has more than 73,000 chargers, both public and shared, and an additional 123,000 is being planned by 2025, which still falls short of the set target of 250,000 chargers in the state by that date. A budget of 500 million USD has been proposed the government to fill the incumbent gap and scale-up the installation work to build a deep-rooted charging network.

It has also been reported that the available incentives provided by the state are too less in quantity compared to the current demand, which calls for a much more extensive incentive program. The CEC has also raised concern that the planned target for EV expansion could lead to a peak charging demand of around 5.5 GW, which raises the electricity demand by 25%. Hence, setting up a proper V2G infrastructure will be important in managing the newly added loads and utilizing EVs as an energy resource.

4.3 EV Charging infrastructure

California is one of the key states that has experienced a rapid deployment of EV charging infrastructure due to its high share of electric vehicles. The state as of Feb. 2021 has a total of 13,330 public charging stations with 37,540 charging outlets, the majority of which are Level 2 chargers with J1772 connectors which accounts for 72% of all charging outlets (USA.gov, 2021). Another, 39,201 Level 2 chargers are installed as shared private charging units (Matt Alexander et al., 2021). Moreover, DC chargers installed in the state account for a total of 1,396 stations with 5,400 rapid DC chargers, which includes 1194 charging stations equipped with CCS and CHAdeMO chargers. California has a substantial Tesla Supercharger network, with 202 stations and 2,953 charging outlets. Comparing the number of charging stations and charging outlets for Tesla Supercharger stations, it can be seen that these charging stations are quite large with an average of 10 charging points per charging station. The share of connector types among public charging points are given in Figure 4.1 while the share of connector types based on accessibility of chargers is given in Figure 4.2. It can be observed that Level 2 chargers with J1772 connectors has the maximum penetration among other chargers including AC and AC Level 1 chargers, thus demonstrating that the market demand for fast chargers is rapidly growing (USA.gov, 2021).

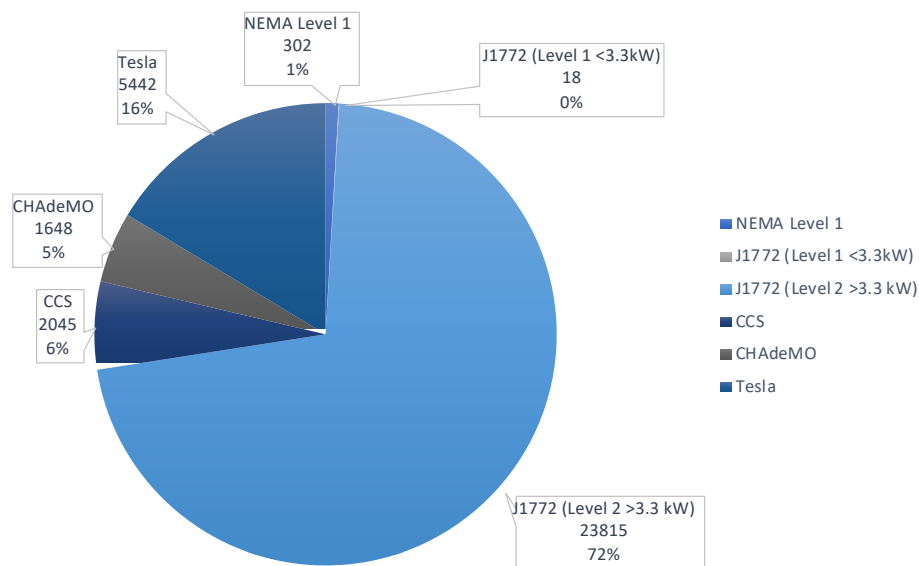

Figure 4.1: Share of connector types among public charging stations in California, USA(USA.gov, 2021)

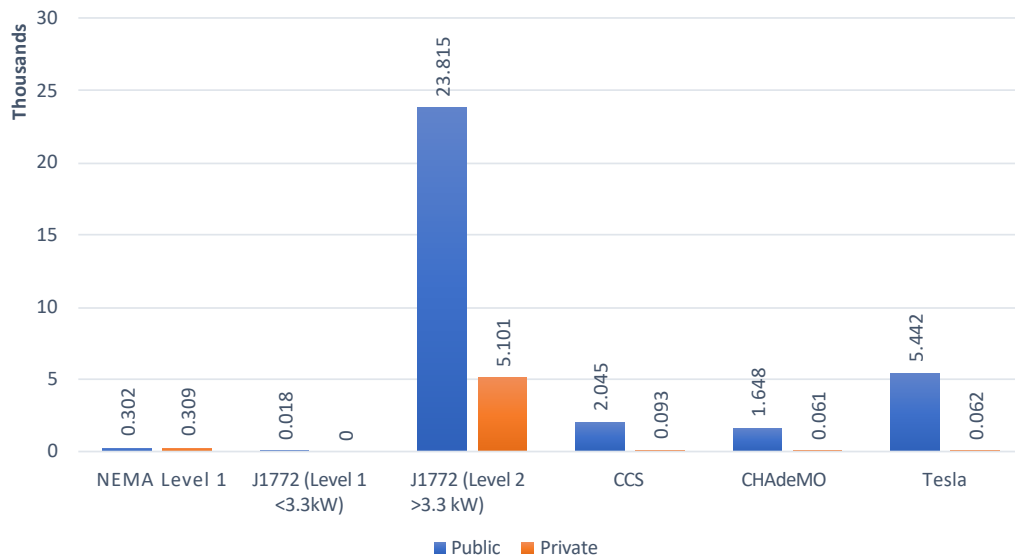

Figure 4.2: Number of charging points based on connector type and accessibility in California, USA (USA.gov, 2021). Here private chargers imply captive private chargers

4.4 EV demand status

As of 2019, the total number of Zero Emission Vehicles (ZEV) in California which include, BEV, PHEV and Fuel Cell Electric Vehicles (FCEV) is 566,902. However, as shown in Figure 4.3, 88% of the total vehicle stock of California are gasoline fueled vehicles, while BEV and PHEV accounts for just 1.063% and 0.866% respectively (*Zero Emission Vehicle and Infrastructure Statistics*, n.d.). Looking at the annual EV sales in Figure 4.4, till 2017 the sales of BEV and PHEV were almost similar, but in 2017 the Tesla Model 3 was launched which boosted the sale of BEV beyond PHEV. The Tesla Model 3 is currently the most popular EV in California.

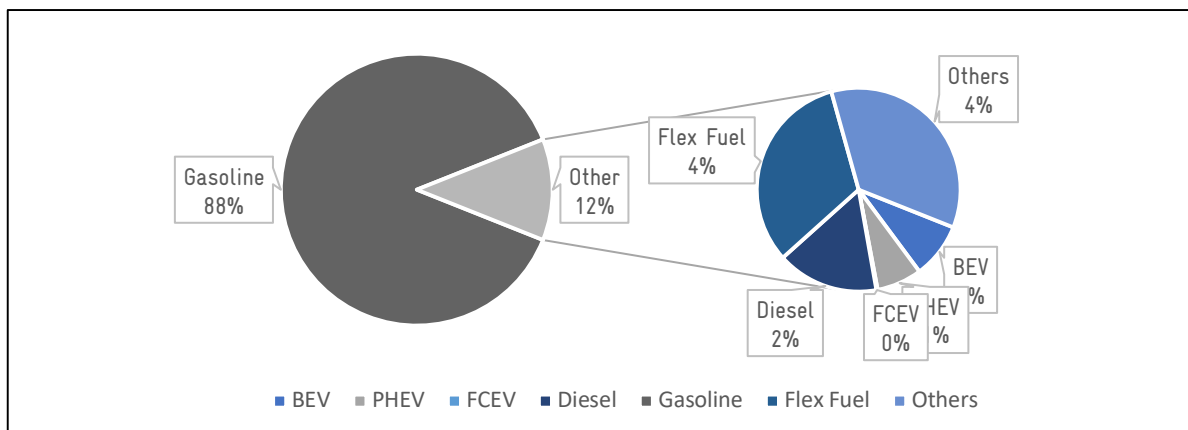

Figure 4.3: Vehicle stock based on fuel type in California till 2019 (*Zero Emission Vehicle and Infrastructure Statistics*, n.d.).

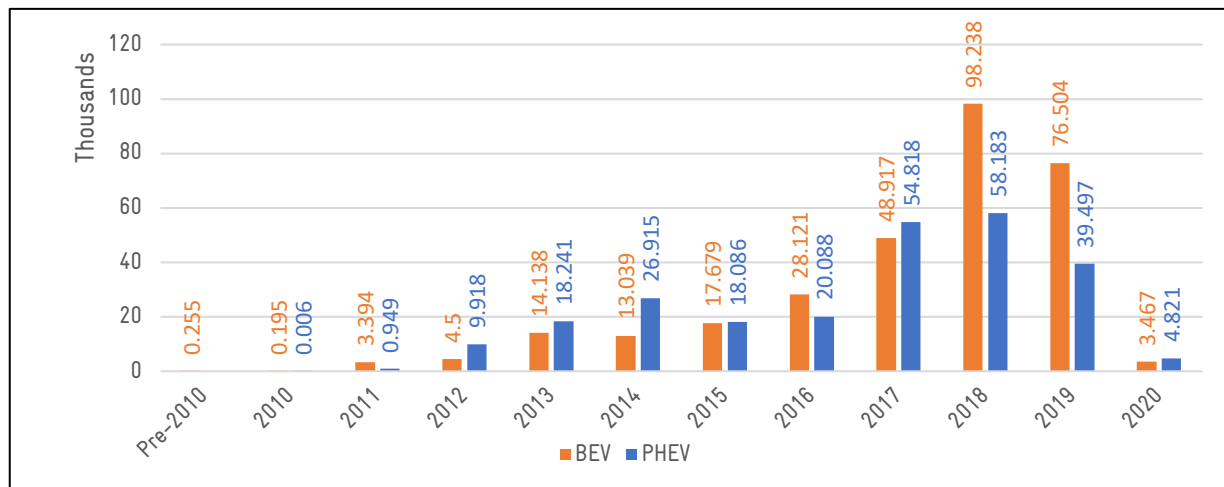

Figure 4.4: Annual sale of EVs in California (Zero Emission Vehicle and Infrastructure Statistics, n.d.).

4.5 EV Integration

As of 2019, the cumulative stock of EV in California has surpassed 500,000 (Zero Emission Vehicle and Infrastructure Statistics, n.d.). In the same time the renewable energy sector has also seen tremendous growth, and now represents 34% of retail electricity sales in the state (J. Coignard et al., 2019). If seen from a macro level, then addition of EV load as such does not appear to pose a major burden on the electricity grid energy demands. As per estimate, 3.9 million EVs could potentially increase the annual electricity demand by 15,500 GWh which translates to roughly 5% of California's annual energy demand. However, at a micro level the addition of EV charging to a residential load, significantly increases the energy demand of the residence. An EV in California is driven for an average of 37 miles per day, i.e., the EV would consume 10 kWh/day, which is a significant portion of 17.5 kWh, a typical energy consumption of a Californian household. Further, EV charging is typically done in the evening between 4 and 7 pm which coincides with the peak period.



Figure 4.5: Geographic distribution of EVs in the state of California. Los Angeles has the highest density of EVs

In terms of geographical distribution, EV adoption is not evenly distributed, as EV adoption is a function of demographics and economic status among other factors. This can be seen in Figure

4.5, which shows the spatial distribution of EV across California (B. J. Coignard & Macdougall, 2019). Therefore, local EV growth forecast needs to be accounted for while designing charging infrastructure. Considering future load growth, distribution feeders are often oversized to accommodate the increased load. In case of California, for 50% of the feeders the margin has been found to be less than 3.1 MW. Although the existing margin can accommodate peak loads, it may not be sufficient for accommodating EV charging load, as at most only 25 DC fast chargers (rated at 120 kW) can be used simultaneously in each feeder.

4.5.1 EV Charging Tariffs

The three major investor-owned territories (IOU) in California, Pacific Gas & Electricity Company (PG&E), South California Edison Company (SCE) and San Diego Gas & Electric Company (SDG&E) have ToU tariffs structured specifically for EVs. These rates have been designed while taking into consideration the high solar generation in California.

4.5.1.1.1 SDG&E

SDG&E has three ToU tariffs structures considering EV charging (*Electric Vehicles*, n.d.),

- EV-TOU: This plan requires a separate meter to track the charging demand of the EV. This plan offers incentive to customers to charge their EV during the off-peak hours.
- EV-TOU-2: This plan uses the existing household meter to track the aggregate power demand of the household. By shifting the energy usage of the entire home to the off-peak periods, the customers can reduce their electricity bills.
- EV-TOU-5: This plan is similar to the EV-TOU-2 plan, but the On-peak and Off-peak pricing is reduced and the super off-peak is reduced to just INR 6.67 (EUR 0.0757), however, a basic monthly service fee of INR 1,186 (EUR 13.465) is levied. This tariff scheme is beneficial to the customers with higher power demand such that the basic monthly fee is repaid by the reduction of peak and off-peak prices.

Table 4.2: EV Tariff structure by SDG&E

			<i>On-peak</i>	<i>Super Off-peak</i>	<i>Off-peak</i>
<i>Summer (June 1st - Oct 31st) (Weekday)</i>	EV-TOU-5	Time of Day	4:00 pm - 9:00 pm (Everyday)	Midnight - 6:00 am (Weekdays) Midnight - 2:00 pm (Weekends & Holidays)	All other periods
		Amount per kWh (INR/EUR)	44.49/ 0.505	6.67/ 0.0757	24.47/ 0.2778

	EV-TOU-2	Time of Day	4:00 pm – 9:00 pm (Everyday)	Midnight – 6:00 am 10:00 am – 2:00 pm in March and April (Weekdays)	All other periods
		Amount per kWh (INR/EUR)	48.19/ 0.5471	Midnight – 2:00 pm (Weekends & Holidays)	28.17/ 0.3198
	EV-TOU	Time of Day	4:00 pm – 9:00 pm (Everyday)	Midnight – 6:00 am (Weekdays)	All other periods
		Amount per kWh (INR/EUR)	48.19/ 0.5471	Midnight – 2:00 pm (Weekends & Holidays)	28.17/ 0.3198
<i>Winter (Nov 1st – May 31st)</i>	EV-TOU-5	Time of Day	4:00 pm – 9:00 pm (Everyday)	Midnight – 6:00 am 10:00 am – 2:00 pm in March and April (Weekdays)	All other periods
		Amount per kWh (INR/EUR)	21.50/ 0.244	Midnight – 2:00 pm (Weekends & Holidays)	20.76/ 0.2356
	EV-TOU-2	Time of Day	4:00 pm – 9:00 pm (Everyday)	Midnight – 6:00 am 10:00 am – 2:00 pm in March and April (Weekdays)	All other periods
		Amount per kWh (INR/EUR)	25.21/ 0.286	Midnight – 2:00 pm (Weekends & Holidays)	24.47/ 0.2778
	EV-TOU	Time of Day	4:00 pm – 9:00 pm (Everyday)	Midnight – 6:00 am 10:00 am – 2:00 pm in March and April (Weekdays)	All other periods
		Amount per kWh (INR/EUR)	25.21/ 0.286	Midnight – 2:00 pm (Weekends & Holidays)	24.47/ 0.2778

PG&E

PG&E also has two EV specific tariffs for the residential users and both the rate plans are non-timed, time of use plans which incentivizes the users to charge their EVs during off peak periods when the electricity price is low (*Making Sense of the Rates*, n.d.).

EV2-A: This plan applies to the net energy usage of the household. So, it is generally more beneficial to the users who have a battery storage along with an EV, so that the energy usage maybe shifted to the low-priced off-peak periods.

EV-B: This plan needs an additional meter to record the energy needs for EV charging and the other customer load, so that the utility can track their EV charging separately from their home energy consumption.

Table 4.3: EV Charging tariff as per PG&E

			Peak	Part-peak	Off-peak
Summer (May 1st to Oct 31st)	EV2-A	Time of Day	2:00 pm - 9:00 pm (Weekday) 3:00 pm - 7:00 pm (Weekends & Holidays)	7:00 am - 2:00 pm and 9:00 pm - 11:00 pm (Monday to Friday except holidays)	All other periods
		Amount per kWh (INR/EUR)	41.67/ 0.47	22.77/ 0.26	10.66/0.121
	EV-B	Time of Day	2:00pm - 9:00 pm (Weekday) 3:00 pm - 7:00 pm (Weekends & Holidays)	7:00 am - 2:00 pm and 9:00 pm - 11:00 pm (Monday to Friday except holidays)	All other periods
		Amount per kWh (INR/EUR)	41.23/0.468	22.55/ 0.256	10.63/ 0.121
Winter (Nov 1st to Apr 31st)	EV2-A	Time of Day	2:00pm - 9:00 pm (Weekday) 3:00 pm - 7:00 pm (Weekends & Holidays)	7:00 am - 2:00 pm and 9:00 pm - 11:00 pm (Monday to Friday except holidays)	All other periods
		Amount per kWh (INR/EUR)	30.27/ 0.343	18.36/ 0.2084	10.92/ 0.124

	EV-B	Time of Day	2:00pm - 9:00 pm (Weekday) 3:00 pm - 7:00 pm (Weekends & Holidays)	7:00 am - 2:00 pm and 9:00 pm - 11:00 pm (Monday to Friday except holidays)	All other periods
		Amount per kWh (INR/EUR)	29.80/ 0.338	18.13/ 0.206	10.88/ 0.1235

For the locations with at least 10 EV chargers, the charge point operators can get enrolled into the EV Charge Network Program, where they get incentives and offers for EV charger installation. The chargers that enjoy these benefits must also participate in the EV Charge Network Load Management Plan. The load management plan requires the program participants to shift their charging requirements on certain occasions called ‘events’ to support the grid. If the participants respond to these events, there will be further reduction in their electricity bill. These events will be called during the following periods,

- Events to increase EV charging: 8 am to 1 pm
- Events to decrease EV charging: 4 pm to 9 pm

The event signal will be sent by 5pm the day before the event via Open ADR 2.0b to each site’s vendor who will pass on the information to the program participant. It is then the responsibility of the program participant to schedule EV charging among the users of the charging station.

SCE

In South California Edison, there is TOU-D-PRIME plan which is time of use tariff constructed to incentivize EV charging during off peak periods as shown in Table 4.4.

Table 4.4: Tariff structure offered by SCE (*Rate Options for Clean Energy Technology, n.d.*)

			Peak	Off-peak
Summer (May 1st to Oct 31st)	TOU-D-Prime	Time of Day	4:00 pm - 9:00 pm	All other periods
		Amount per kWh (INR/EUR)	32.62/ 0.3703 (weekdays) 24.47/ 0.2778 (weekends)	12.60/ 0.143
Winter (Nov 1st to Apr 31st)	TOU-D-Prime	Time of Day	4:00 pm - 9:00 pm	All other periods
		Amount per kWh (INR/EUR)	30.40/ 0.345	11.86/ 0.1346

4.6 Case Studies

4.6.1 EV Submetering

Project Category: Pilot Project

Project Aim: The aim of this study was to demonstrate the use of EV submetering within an EVSE to provide EV charging details to a user without having to install an additional utility meter. This study also estimated the accuracy of these submeters (*Electric Program Investment Charge (EPIC) Submetering for EVs to Increase Customer Billing Flexibility, 2019*).

Project Duration: October 2014 – September 2018

Summary & Learnings: Most charging stations installed in California do not have utility revenue-grade submeters to log the charging load. Also, investor-owned utilities (IOUs) such as PG&E, SDG&E also do not have the capability to receive third-party sub-metered data directly from the EVSE and subtract it from the customer's total energy bill.

The submeters that came along with the EVSE were provided by a group of third-party vendors. The charging stations send data to the vendors using the customer's home Wi-Fi network. The charging data collected from these submeters were processed by these vendors after which the data was sent to the utilities for subtractive billing. The entire process is summarized in Figure 4.6.

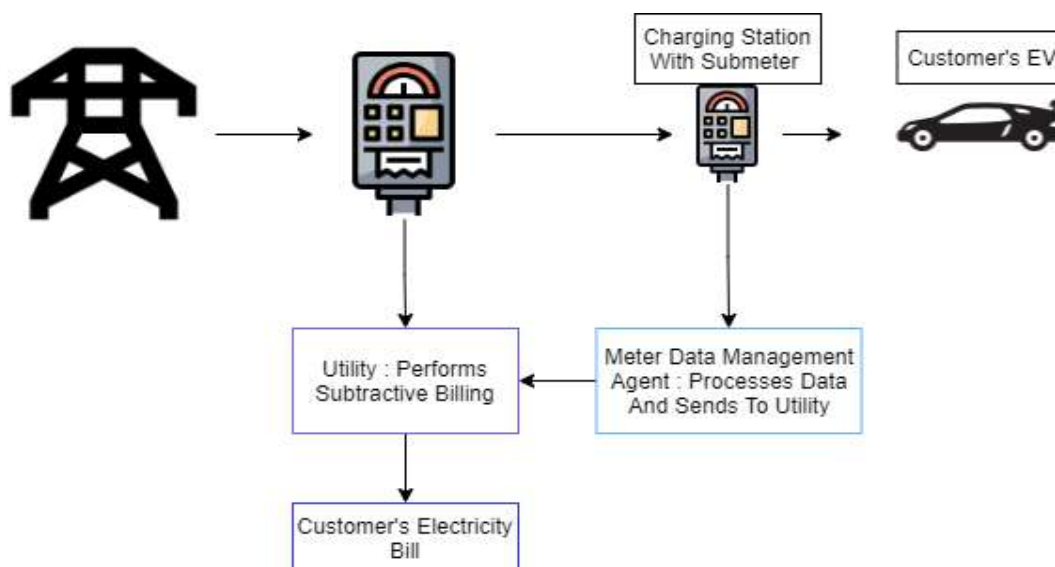

Figure 4.6: Billing process and responsibilities of the submetering stakeholders (*Electric Program Investment Charge (EPIC) Submetering for EVs to Increase Customer Billing Flexibility, 2019*)

To analyze the accuracy of these submeters the submeter measurement were compared to data logger readings that were put in place for 7-10 days at each location. First the accuracy was tested for 15 minute intervals i.e., the measured data after every 15 minutes was compared and the error of measurement of less than +/- 2% was considered as acceptable/satisfactory. The measurement comparative analysis was then relaxed to daily measurements, i.e., the daily energy usage was compared between the logger measurement and the submeter measurement. The percentage of chargers passing the accuracy test is provided in Table 4.5. It can be observed that by considering 15 minute interval measurements, only 5.2% submeters of all the vendors met the 2% accuracy mark. By relaxing the time of measurement to daily consumption, the percentage of chargers that met the desired accuracy increased to 9.6%.

Table 4.5: Chargers passing the accuracy test of maximum 2% error in measurements by utility

	PG&E	SCE	SDG&E	Avg. Pass Rate
Percent submeters passing 15 min interval test	15.8%	0.0%	0.0%	5.2%
Percent submeters passing daily interval test	31.3%	0.0%	0.0%	9.6%

It can be observed that there are various stages of data flow from the EVSE to the utility as shown in Figure 4.7. Therefore, there are four possible stages which might contribute to the submeter measurement error.



Figure 4.7: Data flow from EVSE to utility

Since the charging station submeter directly sent the data to the vendors servers, it was not possible to determine the accuracy of the submeter. The transmission of data through the customer Wi-Fi is another possible source of error. Customer Wi-Fi signals are not 100% reliable, as they may have potential intermittency issues. For example, if the charging stations store a day

of data locally, and the customer Wi-Fi remains un-operational for a day, the data for the entire day may be lost. This was observed in the analysis as there were instances where the data loggers indicated the vehicle charging but no consumption was registered in the submeters, which may be because of interruption of communication. Another potential source of error is the data processing done by the vendors before transmitting it to the utilities. The vendors were not able to share their data processing process citing proprietary reasons, therefore, without insights of the algorithms used, the impact on accuracy due to vendor processing could not be analyzed. Once the data was received by the utilities, it was again processed to calculate the electricity bill of the customer. As per the analysis, there was no error injected in this stage of the process. Another potential reason for the error in the measurements is time synchronization between the utility meter and the submeter as shown in Figure 4.8.

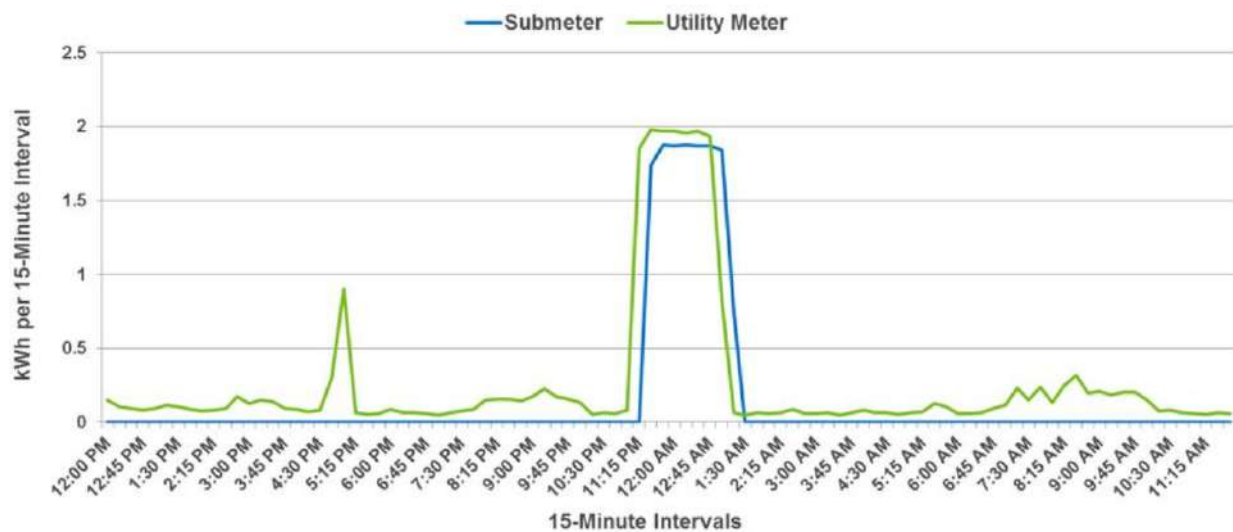

Figure 4.8: Time shift in data between utility meter and submeter(*Electric Program Investment Charge (EPIC) Submetering for EVs to Increase Customer Billing Flexibility, 2019*)

4.6.2 Optimal placement of DC Fast Charging stations

Project Category: Research Project

Project Aim: The main objectives of the study were:

- To develop a transferable methodology for optimal siting of DC Fast charging stations in an urban locality
- Use various parameters such as driving patterns, distribution network capacity, EV adoption, support for disadvantageous communities etc. in preparing the framework
- Use the developed framework to determine potential DC Fast Charging stations in the PG&E's territory

Project Summary:

To determine the optimal location of DC Fast Charging stations, the project was segregated into following different work packages (PG&E, 2016a)

- **Develop EV forecast scenarios:** Two scenarios for EV adoption have been used here to determine the EV market in 2025
- **Assess the current landscape of installed DCFCs in PG&E's territory:** In this task PlugShare's database has been used to determine the locations of all available DCFC in California and PG&E's territory. As there are private chargers too installed by fleet owners, PlugShare contacted these fleet owners to get their charging station details. The existing DCFC locations in California has been marked in Figure 4.9.
- **Determine the locations in PG&E's territory with the highest future demand for charging:** This used an existing transportation model to identify the top 300 one-mile radius bubbles in PG&E's territory that have the highest predicted future demand of unmet demand for charging stations. PG&E used the 'GIS EV Planning Toolbox for MPOs'⁶ to identify these locations.
- **Determine the areas in PG&E's territory with available distribution network capacity:** This task identified which locations in PG&E's territory had available headroom on the upstream distribution network to accommodate the DCFC. It was considered that each DCFC should have minimum of two fast DC chargers of 65kW each. Further, the availability of headroom is considered during the peak load hours.
- **Determine the potential charger hosting sites:** For each of the 300 one-mile radius bubble, potential hosting sites are selected based on
 - The host sites should be among the three-charger demand type (traffic corridor, workplace, home).
 - The sites should have a distribution transformer with enough capacity to accommodate two DCFC of 65kW each within a 300-foot radius

⁶ Toolbox that can be used for planning the location of chargers in California. If the required dataset is available it can also be used for any location. <http://phev.ucdavis.edu/project/uc-davis-gis-evplanning-toolbox-for-mpos/>.

- In the instances where there is no hosting capacity, PG&E listed potential business entities with addresses that would make good DCFC sites.



Figure 4.9: Existing DCFC locations in California (PG&E, 2016a)

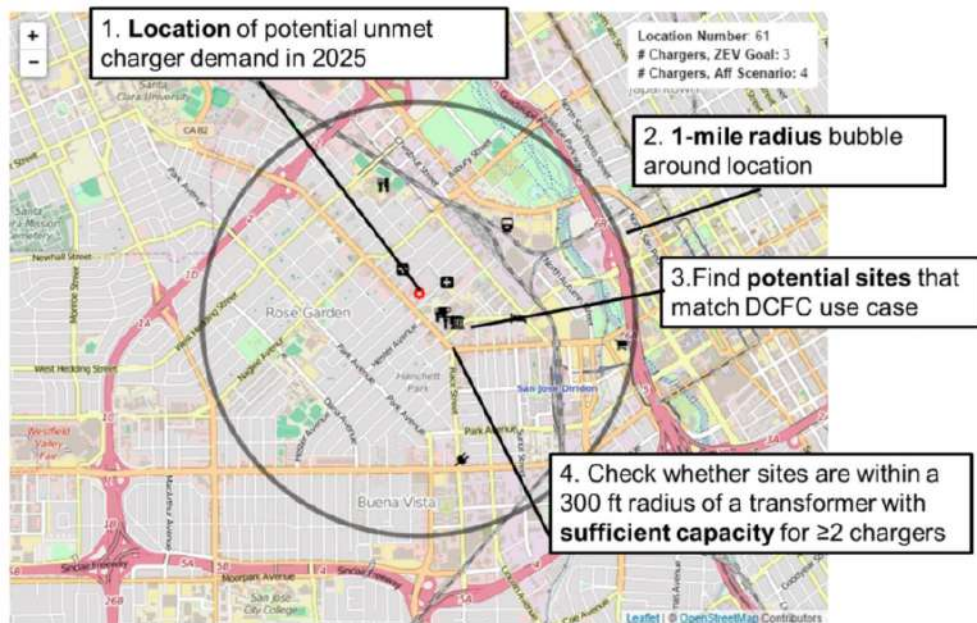
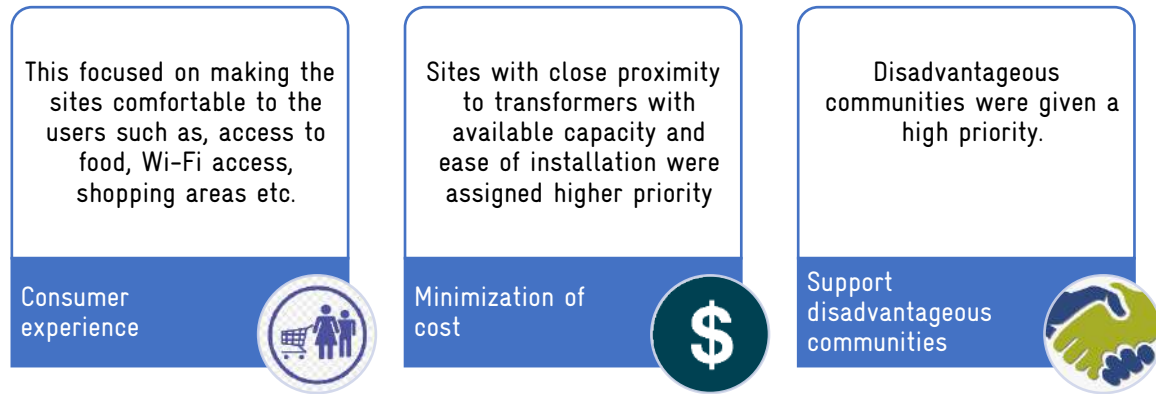

Figure 4.10: Methodology for determination of DCFC location within the one-mile bubble (PG&E, 2016a)

Using the above-mentioned methodology, a total of 14,416 potential EV charger locations were determined with some overlap. By filtering the overlaps, a total of 13,249 unique EV charger locations have been found. To filter the identified sites further, three sets of parameters were weighted to sort the total list of locations,



4.6.3 Electric Program Investment Charge (EPIC) – Vehicle to Home

Project Category: Demonstration Project

Project Aim: To determine the different value streams that can be provided by V2H and also to analyze the potential barriers of V2H and their possible solutions

Project Duration: 2015-2017

Project Summary: Since net zero homes are getting significant focus in California, this study was conducted to analyze the value additions that can be provided by V2H. Although both V2H and V2G provide power flow from the EVs but they have differences in their underlying technology. The key difference between V2G and V2H is the type of inverter used by each system. As V2G must run parallel with other utility generators, so V2G inverters are generally 'Current Source' based which follow the voltage and frequency determined by the grid (grid following inverters). On the other hand V2H isolates the local network from the grid, so V2H inverters are 'Voltage Source' based, that generates its own voltage and frequency command (grid forming inverters) (Pacific Gas and Electric Company, 2018). From the customer point of view, V2G services are grid focused service and are designed primarily to improve the operating conditions of the system. While V2H systems are designed to on the concept of islanding and for the purposes of improving on-site resiliency and reliability.

Table 4.6: Comparison of V2H, V2G and V2H+V2G systems

	V2H	V2G	V2H+V2G
Inverter Type	Voltage Source	Current Source	Both voltage + current source inverters with the capability to switch between the two
Interconnection Standards	IEEE 1547, CA Rule 21 UL 1741		
Commercial inverter available	Yes	Yes	No ⁷
Ideal customer application	Off-grid	On-grid	Both

The key standards for V2G and V2H have been summarized in Table 4.7.

Table 4.7: Key standards for V2G and V2H

Standards	Key areas
SEP 2.0/ IEEE 2030.5	<ul style="list-style-type: none"> • Price & billing communication • Demand Response • Load Control • Energy Usage/ Meter data • DER Communication
NEC/ NFPA 70	<ul style="list-style-type: none"> • Power Connection/ interconnection • Safety standards • Testing guidelines
IEEE 1547	Interconnections to grid
CA Rule 2	Voltage and Frequency standards
UL 1741	Operation of residential storage battery, PV and EV with off board inverter

To analyze the performance of V2H, different test scenarios were constructed as described below.

Test 1: Demonstration of EV providing support during islanding mode or demand response configuration

In this test, the load was isolated from the grid and all the residential loads were connected to the EV. The EV was initially connected to provide power just to the critical loads. The loads were

⁷ Was not available till the publication of the project report in 2018

then ramped up in steps of 1kW and then ramped down to test the load following response of V2H.

Test 2: Cold Load pickup during islanded operation

In this test the EV was asked for cold load pickup⁸ of loads from 1kW to 5kW. As shown in Figure 4.12, the loads were increased in steps of 1kW, however, every step increase in load was followed by completely deloading the EV and then increasing the load again to check the response time of the V2H. The fast response of the EV was satisfactory, and this test showed that EVs can provide cold load pickup services.

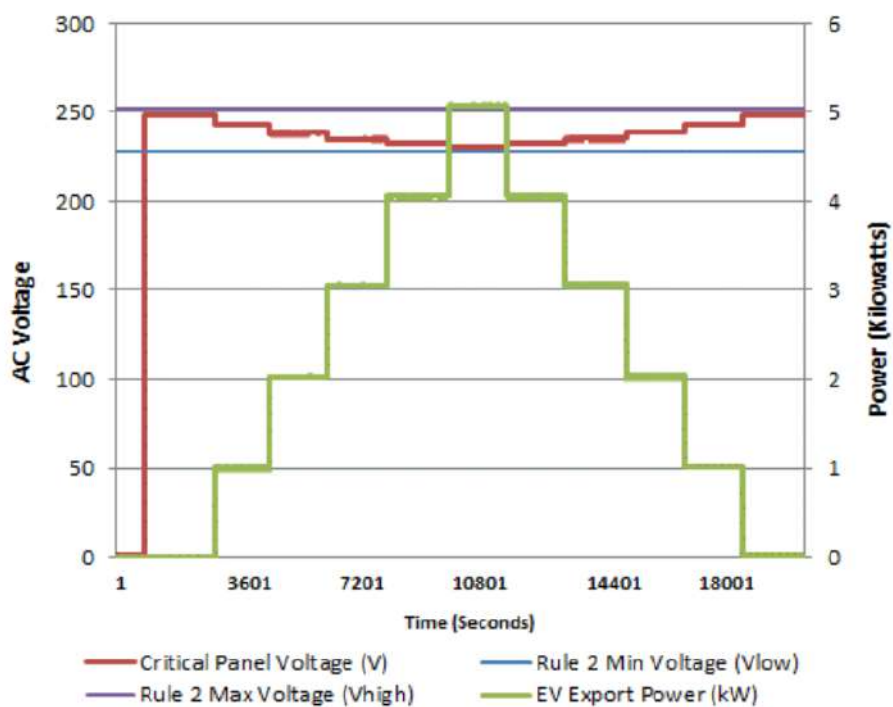

Figure 4.11: V2H in islanded operation (Pacific Gas and Electric Company, 2018)

⁸ Cold load pickup means that the EV has to immediately meet the total load with no slow ramping allowed.

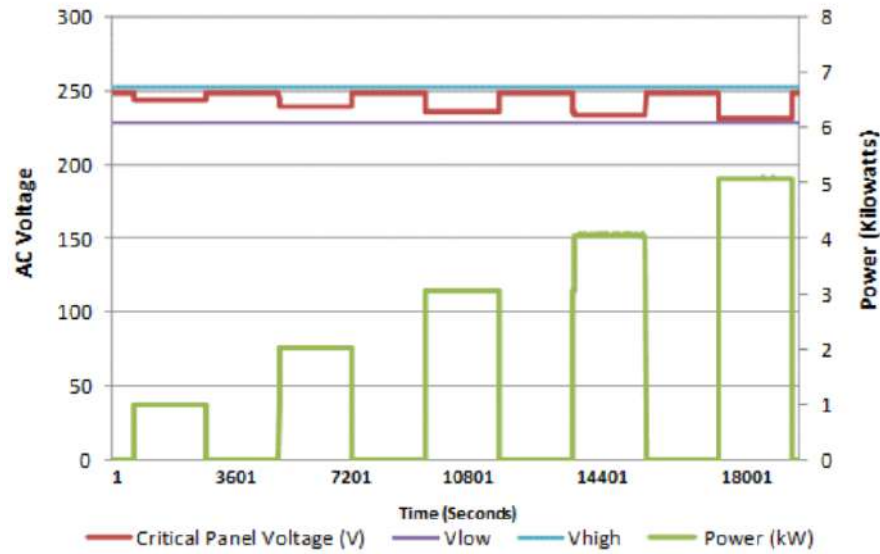

Figure 4.12: Cold load pickup demonstration (Pacific Gas and Electric Company, 2018)

Test 3: EV supporting load in parallel with PV under varying conditions

In this test the loads were initially set at 0 kW. Then EV was connected and commanded to follow the load, while PV was operated in parallel to the EV. The EV operating as a voltage source inverter was able to support the PV in parallel operation and also controlled the EV charging based on the PV generation and the load as shown in Figure 4.13.

The summary of all the tests conducted and their results have been shown in Table 4.8

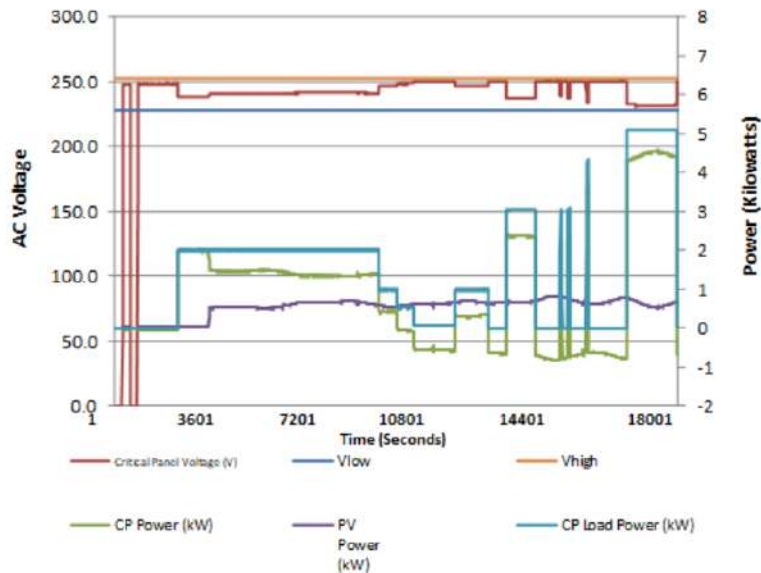

Figure 4.13: Islanded home with EV in parallel with PV(Pacific Gas and Electric Company, 2018)

Table 4.8: Summary of results

	Islanding	Parallel resource	Cold Load pickup	Voltage limits	Load following
EV islanded	Pass	N/A	N/A	Pass	Pass
EV islanded+grid support mode	Pass	N/A	Pass	Pass	N/A
EV islanded + PV	Pass	Pass	Pass	Fail ⁹	Pass
EV islanded+stationary battery	Pass	Pass	Pass	Pass	Pass

Barriers in commercialization of V2H and their potential solutions

Barrier	Description	Potential Solution
Capital Costs	Currently V2H is not cost effective without incentives for participation as the benefits are limited compared to the capital expenditure	Development of market or regulatory mechanisms to minimize the costs of V2H.

⁹ The tests were repeated several times under different conditions. Under one condition the PV generation was high, the EV was charged and also the load was low which resulted in the voltage overshooting the voltage limits. Thus, the test failed in one of the iterations.

Limited value capture opportunities for V2H on reliable grids	V2H is mainly used for emergency backup power and so for resilient reliable grids the need for V2H is limited	The value capture can be improved by incorporating both V2H and V2G services as this will open up more revenue streams for the customer to participate.
DER competition within same solution space	BESS, Solar PV each offer a viable alternative and are commercially available. This makes it difficult for V2H to create its own market.	Market actors can drive V2H competitiveness by focusing on scaling beyond individual systems to maximize value streams that benefit more than just the customer and also by communicating with the customers the cost competitiveness of V2H.

Opinions of automakers on V2G/V2H

Currently OEMs are skeptical about providing bidirectional capability on their vehicles. Vehicle manufacturers are unwilling to permit discharge from their batteries by an outside control due to three main reasons:

- Impact on battery warranty
- Battery lifetime depreciation will not be solely due to distance driven
- Difficulty in marketing if EV battery gets depreciated due to external factors like bidirectional power flow.

The OEMs want to have a function using which they can estimate the battery health based on the distance driven, but by extending the charge/discharge cycle count due to V2H/V2G, the OEMs loses this capability as the batteries may face reduced capacity much earlier than their marketed time period. A potential solution to this is to provide the battery lifetime based on the duration of operation rather than the distance driven. As a result of these issues, except Japan based manufacturers Mitsubishi and Nissan other OEMs do not generally provide bidirectional charging capability in their vehicles.

4.6.4 INtelligent Electric VEhicle INTegration (INVENT)

Project Category: Large scale trial in UCSD Campus (Christensen, 2018)

Project Aim:

- Mitigate volatility of renewables
- Frequency regulation

- Solution to The Duck Curve
 - Mitigate local grid congestion
 - V2B
 - Lower cost of EV ownership

Project Duration: Oct 2017 – Dec 2020

Results: The project has successfully demonstrated Frequency Regulation, Demand reduction using V2G, including during stress events called Flex-Alerts issued by California ISO due to high temperatures across western U.S., which urged the customers to conserve electricity. The Nuvve GIV™ aggregation platform was used for interaction of solar forecasting, building energy management systems and participation in TSO-DSO demand response markets. 9 AC Nuvve Powerports (18kW), 9 DC Hitachi (6kW) chargers were used to charge two Mitsubishi Outlanders (12kWh), seven Nissan LEAFs (24-30kWh), nine Chevy Bolts/BMW i3s/Daimler Smart/Model 3/LEAF. The overall system architecture is given in Figure 4.14.

Learnings:

- The key challenges that need to be addressed for any grid support services are
 - Availability of cars during event duration
 - Paths for EV to access the energy market
 - V2G causes additional battery degradation
- Demand Response and Peak reduction have been proven
- Frequency regulation has been tested but the final pilot results have not been published yet

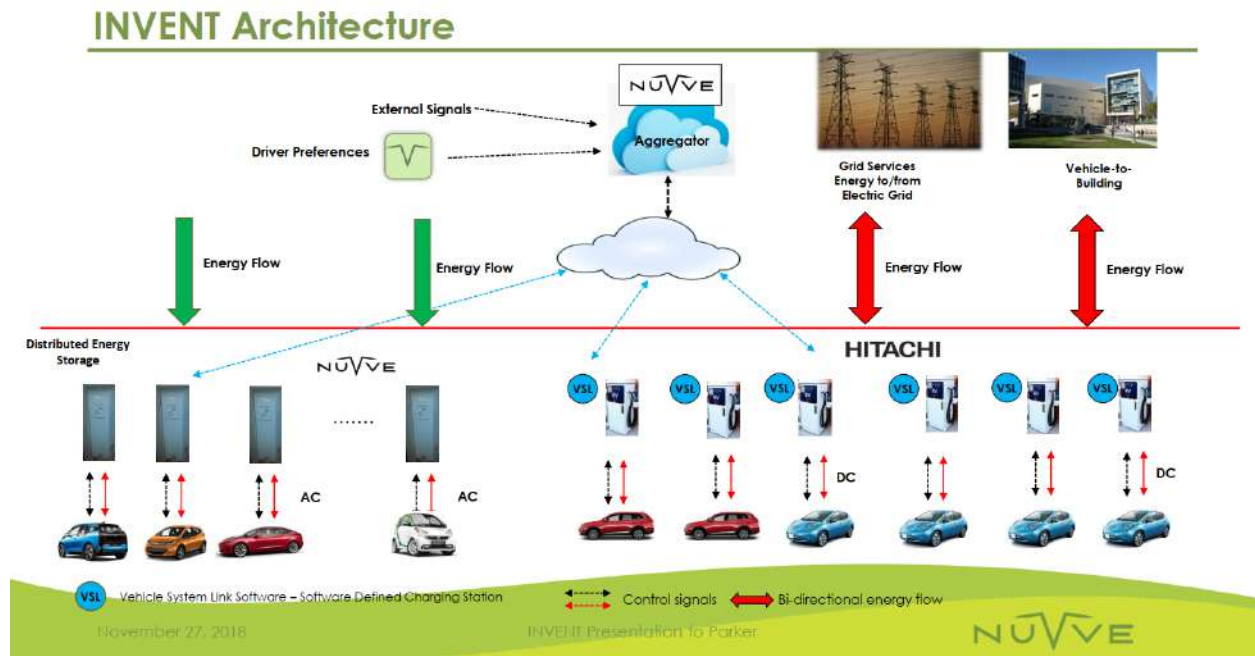
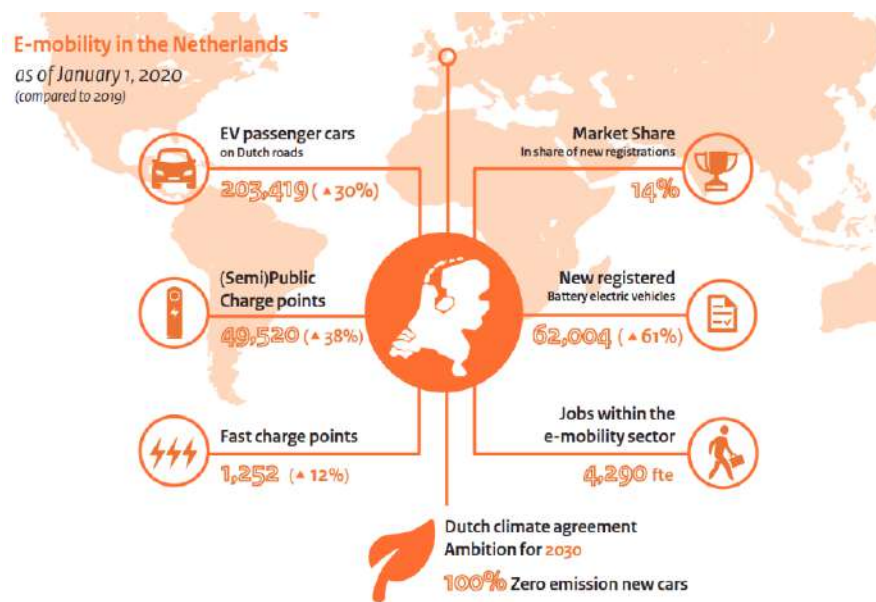

Figure 4.14: Architecture of INVENT Project (Christensen, 2018)

Chapter 5. The Netherlands

The Netherlands has amongst the densest EV charging networks globally and pioneered the deployment of charging stations along the entire length of the motorway network (Consultation et al., 2016). Policy ambitions which impact the development of EV charging infrastructure have been set at central government and European Union level. The Dutch government has set ambitious targets for all the new cars to be emission free by 2030 and adopted an integrated approach to meet the EV charging infrastructure targets (Laadinfrastructuur, 2019).

The central government uses demand-driven positioning of charging points which will create a



There was a 61% increase in the new BEV registrations from 2019 with overall passenger EVs exceeding 200,000

Figure 5.1: E-mobility in the Netherlands (Source, The National Charging Agenda)

suitable mix between private, semi-public, public and fast-charging stations (Ministry of Economic Affairs, 2020). Figure 5.1 gives an overview of the electric mobility landscape in the Netherlands which has seen significant growth in EV market share, semi-public charge points and fast charge points. The country targets to have 100% zero emission vehicles by 2030.

5.1 Background for policy making environment

The National Knowledge Platform for Public Charging Infrastructure (NKL) was founded in 2014 with the support of the central government. The NKL aims to facilitate knowledge-sharing among parties and is a partnership of organizations which are involved in the public charging of electric transport in the Netherlands. The national government sponsors projects related to EV charging infrastructure deployments while the local and regional authorities provide investments in

equipment. Grid operators provide investments in public recharging and operation of charging points. Electricity generators and charge point operators operate private charging points and also provide public charging services.

The National Charging Infrastructure Agenda (Laadinfrastructuur, 2019) identifies the following public organizations and associations as key stakeholders in forming a concrete multi-year policy program.

- Ministry of Infrastructure and Water Management
- Netherlands Enterprise Agency (RVO)
- ElaadNL, the knowledge and innovation centre in the field of (smart) charging infrastructure in the Netherlands
- Netherlands Knowledge Platform for Public Charging Infrastructure (NKL)
- Association of Netherlands Municipalities (VNG)
- Cities of Amsterdam, Rotterdam, The Hague and Utrecht
- Interprovincial Overleg (IPO)
- Metropolitan Region Amsterdam electric (MRAe)
- National Sustainable Energy Association (NVDE)
- Dutch Organization for Electric Transport (DOET)
- RAI Automotive Industry NL
- Automotive NL
- eViolin, charge point operators

5.2 EV Charging infrastructure policies and regulations

As mentioned earlier, policy objectives on the development of EV charging infrastructure in the Netherlands have been set at both central government and EU levels. The EU green deal has set a target of 1 million public recharging and refueling stations for the 13 million zero- and low-emission vehicles expected in the region by 2025 (Mulvaney, 2019). EV charging infrastructure roll out in the Netherlands began in 2009 (Helmus et al., 2018) and since then the number of charging stations has grown significantly. As shown in Figure 5.2, the Netherlands achieved a growth in EV charging infrastructure deployment of 162.4% between the period of 2017 to 2020. Table 5.1 gives an overview of the EV charging policy and regulations in the Netherlands based on the analytical framework presented in Table 5.1. The development of EV charging policies considers two fundamental perspectives: the supply (developers of EV charging infrastructure and charging service providers) and the demand side (EV users). This report applies the analytical

policy framework developed by the Florence School of Regulation (Bhagwat et al., 2019). The various elements to be considered within these perspectives are shown in the table given below.

The Dutch government has been one of the most proactive and early movers in establishing various programs to encourage uptake of EV and in the establishment of EV infrastructure. On the supply side, following the EU mandate, the Dutch government has been working with local authorities and public services providers to ensure green bus mobility powered by regional green power generation, access to public charging points for EV users. In this regard there are targeted incentives to setup the infrastructure and rebates on electricity use. Also, the government has provided guidance on bi-directional flow of power and in the use of V2X grid services. On the demand side, the technical protocols have been clearly defined, and there is guidance on payments methods to provide ease of access and e-Mobility across service providers. In terms of harmonization, data is available across service providers both public and semi-public.

Table 5.1: EV Charging infrastructure policy in the Netherlands

Policies Enabling EV charging on supply-side		
Element	Policy Instrument	Measures
Definition of a fundamental market design framework to limit distortions and entry barriers	EV charging definitions and explanation	Produced by the Netherlands Enterprise Agency, the publication aims to give clear definitions and explanations on relevant aspects of EV charging and is made available to the public with regular content updates.
	Vision on the Charging Infrastructure for Electric Transport	The vision also provides guidelines for policy rules at municipality level to provide clarity regarding the criteria and conditions under which the municipality will cooperate with the installation of EV charging infrastructure in public spaces and allocation of parking spaces for the recharging of EVs.
	Publicly Accessible Electric Charging Infrastructure Green Deal	The policy indicates that the government will eliminate uncertainty regarding market organization of public charging infrastructure and promote the rollout of publicly accessible charging infrastructure

The incentive for launching the EV charging market	Environmental Investment Tax Scheme (MIA) for charging infrastructure	The scheme provides tax incentives businesses to make investments in environmentally friendly technologies including EV charging infrastructure. Private charging points qualify for the MIA provided the total investment does not exceed INR 43,98,354 (EUR 50,000) (Ministry of Economic Affairs, 2020).
	Electricity tax breaks for public EV charging infrastructure	The first 10 000 kWh of electricity consumption attracts a higher rate of tax than subsequent electricity consumption, however, EV charging station operators pay the rate normally paid after the first 10 000 kWh for all electricity consumption up to 50,000 kWh.
Prioritization in terms of EV characteristics and social geography	Administrative Agreement on Zero-Emission Buses (2016)	By 2025, new buses will be using 100% renewable energy or fuel which should be generated regionally.
Elimination of administrative barriers for establishing charging stations	National Charging infrastructure Agenda	The policy aims at ensuring strategic & data driven placement of public charging infrastructure. At a regional level, the European Network for Cyber Security entered into an agreement with ElaadNL for the two to jointly collaborate in research and development of security technologies to protect the region's smart charging infrastructure against cyberattacks.
	Establishment of the Formula E-Team	The national public-private platform aims to develop EV charging infrastructure and new zero-emission mobility policies in the country (ISGF, 2019).
Mandate on the utilization of V2X capabilities	Open Charge Point Interface (OCPI) protocol	The OCPI includes agreements on smart charging and advanced forms of use such as support for charge profiles and discharge of EVs to the power grid.
Policies Enabling EV charging on demand-side		
Element	Policy Instrument	Measures

Technical standardization of chargers for interoperability	Open Charge Point Interface (OCPI) protocol	The standard set consists of ten categories detailed for charging infrastructure in the Netherlands.
	National Charging infrastructure Agenda	The policy aims at ensuring accessibility of information such as location and availability of charging point and charge rates
Specification of the use of a wide range of payment methods	Dutch Guidelines (B117)	The guidelines require charging point operators to accept any valid charging card from an e-Mobility Service Provider for access and payment.
Harmonization of cross-border/cross-provider user registration for accessing charging infrastructure	Open Charge Point Interface (OCPI) protocol	The independent open protocol supports connections between mobility service providers, charge point operators and navigation service providers. The national roaming system between independent operators and providers ensures EV users can access public charge stations connected and semi-public charging stations. The system connects over 25 operators and providers.

5.3 EV Charging infrastructure

The Netherlands has a relatively high number of publicly accessible chargers per EV with 1 charger per 4-8 EVs (IEA, 2019). The central government developed the present market model through the publicly available charging infrastructure green deal, in order to achieve a further cost-price reduction. Figure 5.2 shows the impact of policies and incentives for publicly accessible charging infrastructure which have grown significantly in the last decade. In the initial phase, the charging of EV was free for all users, and a regulated tariff was introduced as the market matured (Wolbertus, 2016). Currently, the pricing for EV charging is fully deregulated, thus allowing the market to set the price (Bhagwat et al., 2019).

The central government uses the ‘charging tree’ for infrastructure in the electric transport policy.

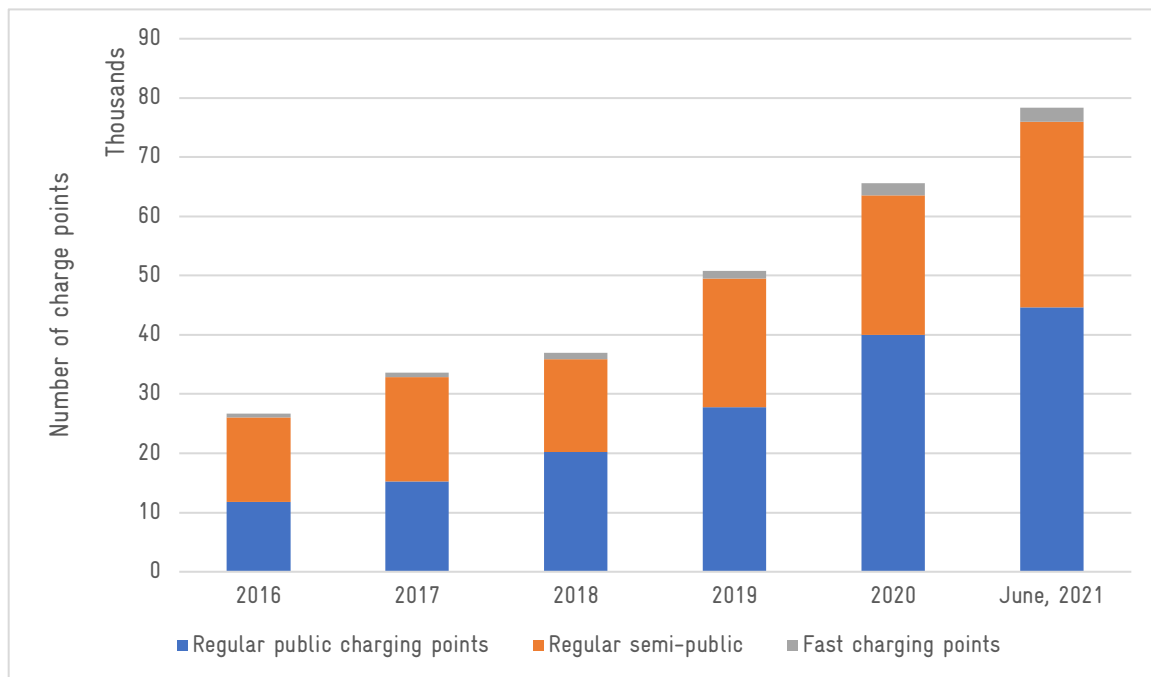

Figure 5.2: Trends in EV Charging Infrastructure deployment in the Netherlands (NEA, 2021) ¹⁰

This policy adopts a demand-driven approach to charging infrastructure deployment and maps the central government’s policy agenda which includes incentivizing market stimuli, organized collaboration and investment in knowledge and collaboration (Ministry of Economic Affairs, 2020).

¹⁰ Regular charging points are ≤ 22 kW, Fast charging points are > 22 kW

Charging points in the Netherlands are differentiated according to accessibility. Private charging points are installed on a private site and connected to a private electricity supply. Public charging points provide non-discriminatory access 24 hours every day while semi-public charging points are accessible to all users with restricted public access due to operating times. Figure 5.3 shows EV charging points in the Netherlands. Private charging points dominate the market with an estimated 151,000 across the country.

As of June 2021, there are approximately 0.18 million private EV chargers in the Netherlands (NEA, 2021), with almost all EV owners expected to have an EV charging cable that can be plugged into any standard outlet, or a dedicated EV charger supplied by the EV manufacturer. Type 2 AC chargers are the most prevalent among private EV chargers.

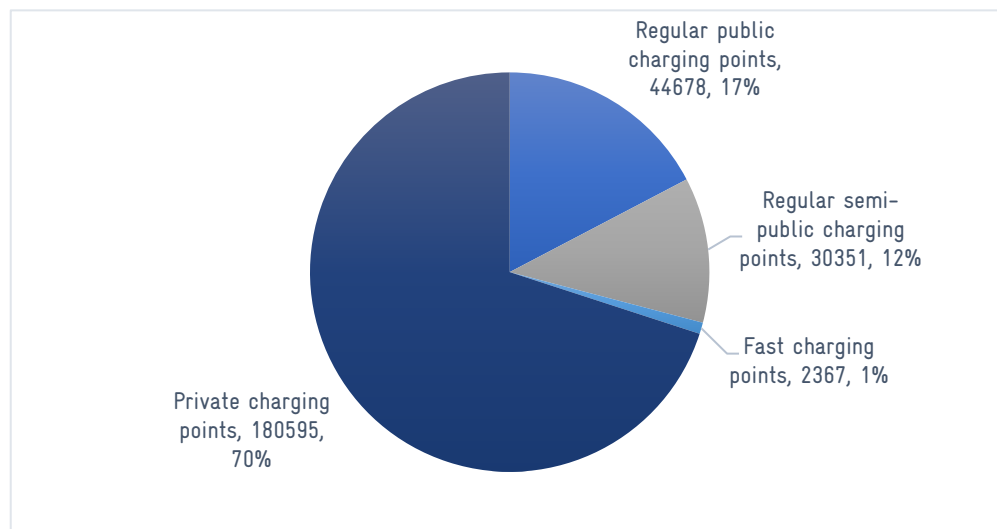

Figure 5.3: EV Charging points in the Netherlands (NEA, 2021)

5.4 EV demand status

Electric vehicles can be classified according to their chassis and the type of engine. The Nederland Elektrisch provides data on registered passenger EVs by engine type as shown in Figure 5.4. BEV registrations surpassed PHEV registrations in the Netherlands in 2019. The share of EVs in the Netherlands is growing, with BEVs accounting for 13.9% and PHEVs accounting for 1.2% of the total market share in 2019 (IEA, 2020).

PHEVs began to decline in 2016 due to a realization by the government that consumers were purchasing PHEVs to gain the incentive benefits without using the electric motor. The policy shift towards incentives for BEVs had the intended effect as BEV sales took off from 2016 as shown in Figure 5.4.

The share of new BEV and PHEV registrations has increased from 6.7% of total new registered passenger vehicles in 2016 to 18.1% of total annual registered vehicles in 2020 as shown in Figure 5.5.

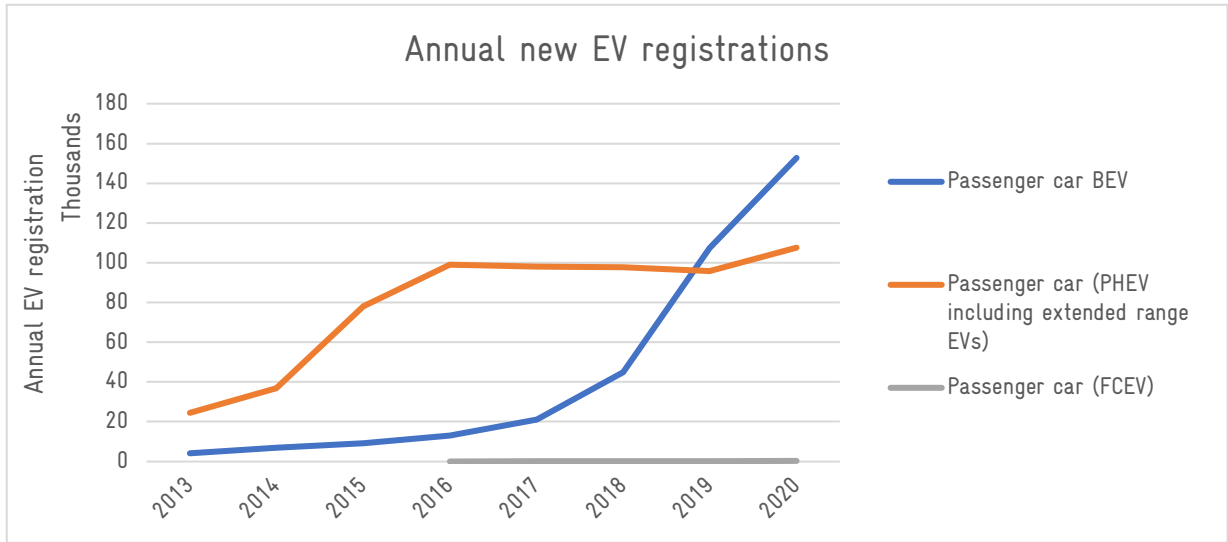

Figure 5.4: Annual Registered passenger EVs by engine type (IEA, 2020)

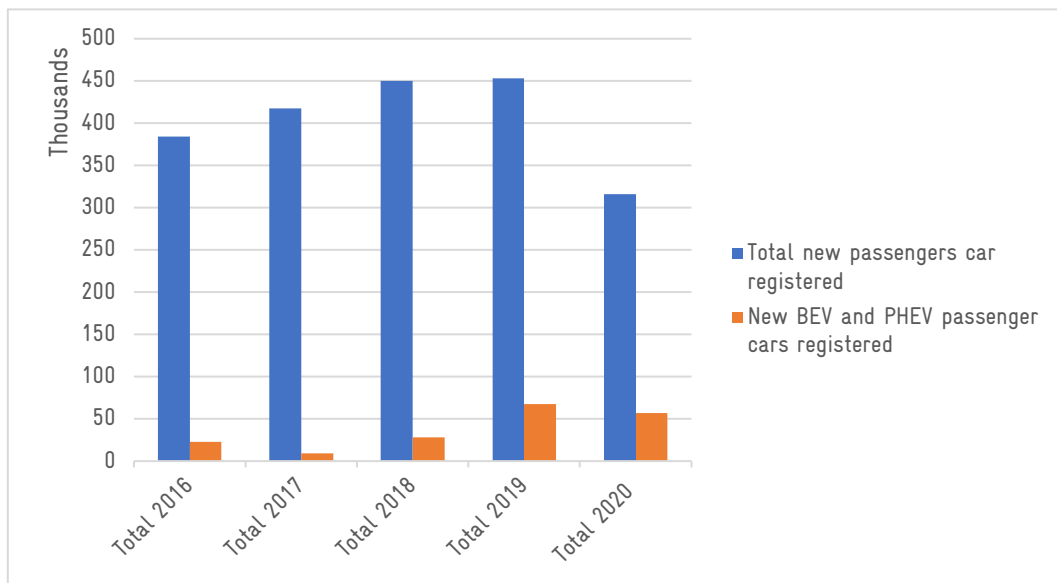

Figure 5.5: EVs market share (RVO, 2020)

The EV models to sell more than 6,000 units in 2020 were the Volkswagen ID.3, Tesla Model 3, Hyundai Kona EV and the Kia Niro EV (Teslarati, n.d.). Figure 5.6 illustrates the registered EVs in the Netherlands according to chassis type.

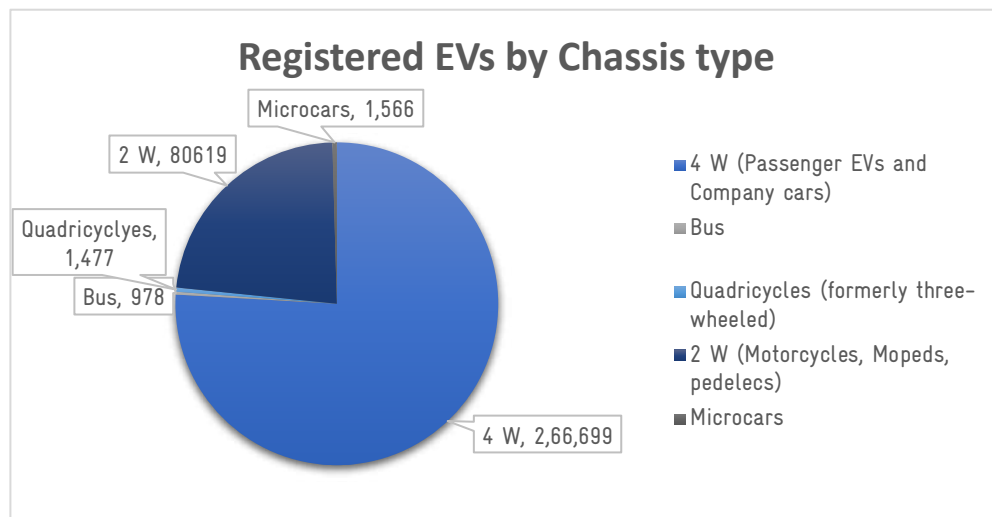

Figure 5.6: Registered EVs by chassis type in the Netherlands (RVO, 2020)

Four-wheeler passenger EVs and company cars dominate the market while two wheelers also form a significant share of the market (including motorcycles, mopeds and pedelecs).

5.5 EV integration

From the power system perspective, EVs can be considered as an additional load and as a potential source of flexibility with V2X capabilities (Bhagwat et al., 2019). Electricity system operators have collaborated with research centers to determine the extent to which smart charging can limit the impact of EVs on the electricity grid. The country targets 1 million electric cars in 2025 which would result in an additional electricity demand of 3 TWh per year, adding around 2% to total demand (Triple E, 2014).

Quite a number of provinces and localities in Netherlands have added electric buses to their public fleet. From 1st April 2018, 100 electric VDL Citea SLFA buses were put in service in the region of Amsterdam and Schiphol. These buses use 23 Heliox rapid chargers (450kW) and 84 Heliox

depot chargers (30kW) for their charging needs. This fleet of buses is expected to expand to 258 by the end of 2021 (*Hybrid and Electric Vehicles The Electric Drive Hauls*, 2019).

TenneT which is the Dutch TSO, is responsible for maintaining grid balance and is currently involved in a pilot project with energy aggregator Vanderborn. Depending on the grid balancing situation, TeneT requests Vanderborn to start or stop the charging process (*Hybrid and Electric Vehicles The Electric Drive Hauls*, 2019).

Vattenfall, an energy company in the Netherlands has introduced reduced electricity prices based on time of vehicle charge through their VoordeelLaden plan (Vattenfall, n.d.). Through this plan, during off-peak hours which is determined by the respective grid operator, the customer is charged a lower variable electricity rate compared to the fixed off-peak and normal rate but charged higher during daytime peak periods. Further as Vattenfall has already significantly invested in wind energy, the utility has also created a unique system to utilize their wind power for EV charging. Eighty charging stations owned by a different Dutch municipality have also adopted this system to transition EV charging to 100% fossil fuel free. Using this approach, the charging power of the EVs is determined by the amount of energy produced by renewables. As solar and wind are variable resources, so the amount of energy generated by them fluctuates with the weather conditions. For higher spells of wind and solar generation the EVs are charged at their maximum rated speeds, however, for lower supply scenarios the charging speed is reduced temporarily. This is achieved as the algorithm links the charging stations to the balancing market, where the amount of electricity generated and consumed is precisely monitored. Every 15 minutes the charging software checks the availability of energy and adjusts the capacity of the charging stations accordingly. But this system may have some issues such as low charging power leading to low energy content in the EV battery when the EV is plugged out. To circumvent this issue, the software has a built in restriction that the EV is charged at maximum power for the first 30 mins and that the charging capacity is not reduced for more than 30 mins in a 3 hour period (*Smart Charging Stations for a More Sustainable Grid - Vattenfall*, n.d.).

A similar smart charging algorithm is also used by the Jedlix which provides smart charging solutions through Over-the-Air (OTA) technology. Their smart charging algorithm just requires the time by which the user wants the EV to be fully charged. The optimal charging plan is then created by considering the available capacity in the power grid, RE generation and also the price of energy (Jedlix, 2021).

5.5.1 Installation of Private Chargers:

Liander which is one of the largest Distribution network operators in Netherlands has the following procedure for installation of private EV chargers for its residents (*A Suitable Connection for Electric Driving*, n.d.)

- The customer has to first contact a specialized company¹¹ to provide the charging station.
- These companies will first analyze the current contracted load and capacity of the residential distribution panel and determine if the existing electrical connection needs to be upgraded.
- For upgradation of electrical connection, the customer has to pay Liander the necessary upgradation fee¹².
- After the necessary upgradation to the electrical connection, the specialized company will install the EV charger.

5.5.2 Requirements for Bidirectional Chargers

ElaadNL is a knowledge and innovation centre for smart charging and the EV charging infrastructure and has been initiated by the Dutch grid operators. ElaadNL has issued a draft for

¹¹ List of companies include: Allego, Blue Corner, Eneco Mobility, EV-Box BV, Stichting ElaadNL, Fastned BV, Greenflux BV, LastMileSolutions, NewMotion, Vattenfall InCharge, Plugsurfing, Travelcard Nederland BV, Vanderbron, Digital Charging Solutions GmbH, Optimile, Eco-movement BV, MultiTankcard, Charge4Europe GmbH, ChargePoint Networks BV, Alfen ICU BV, Kuwait Petroleum (Belgium) NV/SA, E-Nuevo among other.

¹² Upgradation Cost

<i>Old Connection</i>	<i>New Connection</i>	<i>Rate (incl VAT)</i>
1 phase 10 A	1 phase 35 A	INR 28,586 (EUR 324.97)
1 phase 20A/25A	1 phase 35 A	Free
1 phase 20A/25A	1 phase 40 A	INR 50,013 (EUR 568.55)
3-phase 35 A/phase	3 phase 35 A – 80A/phase	INR 28,586 (EUR 324.97)
1 phase 10A/20A/25A/35A	3 phase 25A – 80A/phase	INR 28,586 (EUR 324.97)

the general requirements for implementation of bidirectional charging (ElaadNL, 2019a), summarized below

- The CPO which has bidirectional chargers installed should report the location of the V2X chargers to the local DSO via the platform www.energieleveren.nl/. This site maintains a registry of all distributed generations installed in the Dutch grid.
- The standards for connection to the distribution grid that needs to be followed for bidirectional chargers are
 - NEN-EN 50549-1:2019: Requirements for generating plants to be connected in parallel with distribution networks - Part 1: Connection to a LV distribution network - Generating plants up to and including Type B
 - VDE-AR-N 4105: Power Generating Plants in the Low Voltage Grid
- The EVSE should have proper physical signs that it is capable of bidirectional charging.
- The charging should be controllable via a central system.
- It should be possible to charge and discharge within the same transaction
- Unbalanced phase supply should be avoided.
- The supplied energy from and charged energy to the vehicle must be measured on different registers of MID-certified meters and both the registers should be readable via a central system.
- The V2X system must be equipped with means to automatically disconnect from the grid during power outage (anti-islanding).
- DSO requirements
 - For production units below 800W
 - The power factor in the transfer point of a connection may be between 0.9 capacitive and 0.9 inductive
 - Protection for undervoltage that responds within 2 seconds at 80% of nominal voltage
 - Protection of overvoltage that responds within 2 seconds at 110% of overvoltage
 - A protection for frequency variation that responds within 2 seconds at frequencies outside of 48Hz - 51Hz.
 - Others (>800 W)
 - The production unit is able to stay connected to the grid and in operation within the following bands

- In the frequency band of 47.5Hz to 48.5Hz during 30mins
- In the frequency band of 48.5Hz to 49Hz during 30 mins
- In the frequency band of 49Hz to 51Hz for unlimited duration
- In the frequency band of 51Hz to 51.5Hz during 30 mins
- The unit should be able to activate frequency response in which
 - The frequency threshold value is adjustable between 50.2 Hz and 50.5 Hz
 - The droop is adjustable between 4% and 12%
 - The default setting of droop is 5%
- The electricity production unit may reduce its active power at a frequency of 49.5Hz with a gradient of 10% of the maximum capacity at 50Hz per frequency drop of 1Hz.
- The production unit should be able to resynchronize to the grid if
 - The voltage is between 0.9-1.1 pu
 - The frequency is between 49.9-50.1 Hz
 - The minimum time the voltage and frequency are in between the values mentioned is 60 seconds.
- A production unit with maximum capacity higher than 11 kW connected to the LV grid should be at least equipped with
 - A measuring device for the current
 - A signaling function whether the electricity production unit is connected in parallel to the grid.
- The protection should be
 - A protection for undervoltage that responds within 2 seconds at 0.8pu voltage and within 0.2 seconds at 0.7 pu voltage
 - A protection for overvoltage that responds within 2 seconds at 1.1 pu voltage
 - A maximum current/time protection
 - A protection for frequency variation that responds within 2 seconds at frequencies outside of 47.5 and 51.5 Hz.
- Interfaces and protocols for communication
 - The communication between EVSE and EV for bidirectional charging should conform with the following standards

- CHAdeMO
- ISO/IEC 15118-20 (draft)
- The communication between EVSE and the central system is in conformity with the OCPP 2.0 specification
- Monitoring and Data analysis
 - The data to be provided consists of at least
 - Meter readings (every 15min), including current and voltage per phase
 - Location data of charging points
 - The data is to be transmitted via
 - API
 - OCPI

Quantitative analysis of the available flexibility from EV fleet

Integration of EV into the grid has elevated the flexibility offered from the demand side. The quantification of the amount of flexibility offered has been explained here (Sadeghianpourhamami et al., 2018). Flexibility provided by EV is however dependent on the EV behavior characteristic, specifically, where the vehicle is charged, the charge duration and the time of charge.

The data for the analysis of EV user behavior has been collected from ElaadNL between 2011 to 2015. The dataset contained 1.5 million charging sessions. Figure 5.7 shows the clusters based on the location of charging. It can be inferred from the figure that the charge near home cluster is the largest, accounting for 27.84% of the total data. The charge near work forms the smallest cluster with only 9.3% of the total sessions. Also, for home charging, the charging generally starts later in the day and it either departs further into the day or in the morning of the next day. While in the charge near work cluster the EV arrive early and depart later in the day. There is no specific arrival time for park to charge cluster, but they charge for short durations and don't stay overnight.

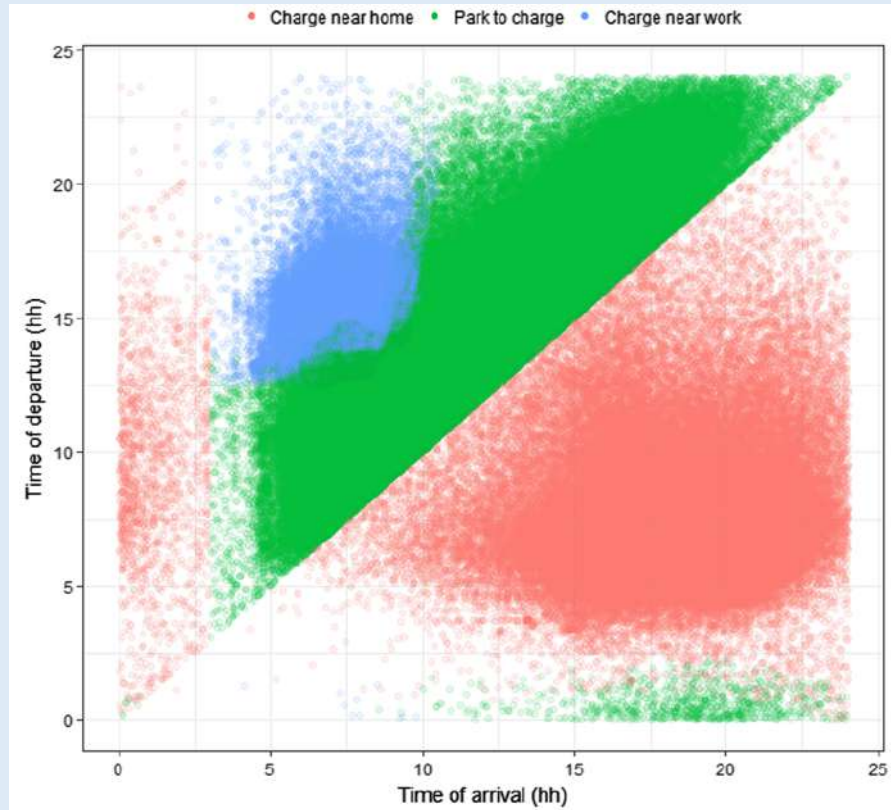

Figure 5.7: Behavioural analysis of the EV charging sessions based on their location of charging (Sadeghianpourhamami et al., 2018)

To analyze the flexibility offered by such driving patterns, the wind and solar data was sourced from Belgian's electricity transmission system operator. Both the EV charging data and the RE data were then rescaled accordingly to keep similar monthly wind to solar ratios as those found in Netherlands. The flexibility is defined based on three factors

- The amount of deferrable energy
- The time of availability
- The deadline/permmissible duration to exploit the offered flexibility.

The flexibility has been quantized using the following parameters

Eflex: it is the fraction of the maximum energy that could be consumed beyond t_{BAU} , (t_{BAU} is the time of completion of charging in the BAU scenario)

$$Eflex = \frac{\text{Energy consumed beyond } t_{BAU}}{\text{Maximum possible energy consumption beyond } t_{BAU}}$$

Tflex: it is the fraction of the maximum delay beyond t_{BAU}

$$Tflex = \frac{t_{coordinated} - t_{BAU}}{t_{depart} - t_{BAU}}$$

Where $t_{coordinated}$ refers to the time of completion of charging in the coordinated charging. The combination of T_{flex} and E_{flex} quantizes the flexibility offering from the EVs. When $T_{flex}=E_{flex}=1$, it means that the energy consumption is deferred as much as possible and the consumption beyond t_{BAU} is at the maximum capacity. Another interpretation of E_{flex} is that $(1-E_{flex})$ gives the SOC% of the EV at t_{BAU} .

Figure 5.8 shows the change in EV load due to coordinated charging. In the load flattening scenario shown in Figure 5.8 (b), the load is typically shifted away from the morning peak towards the afternoon valley. So, shifts of up to 1hr is seen and shifts beyond 4hrs is comparatively less. On the other hand, the EV charging load is shifted from the evening peak period to the late-night off-peak period. In case of load balancing scenario shown in Figure 5.8 (c), the EVs accommodate the RE generation, for which they shift their loads accordingly. Longer shifts from the evening peaks are observed when there is substantial renewable generation in the night valleys.

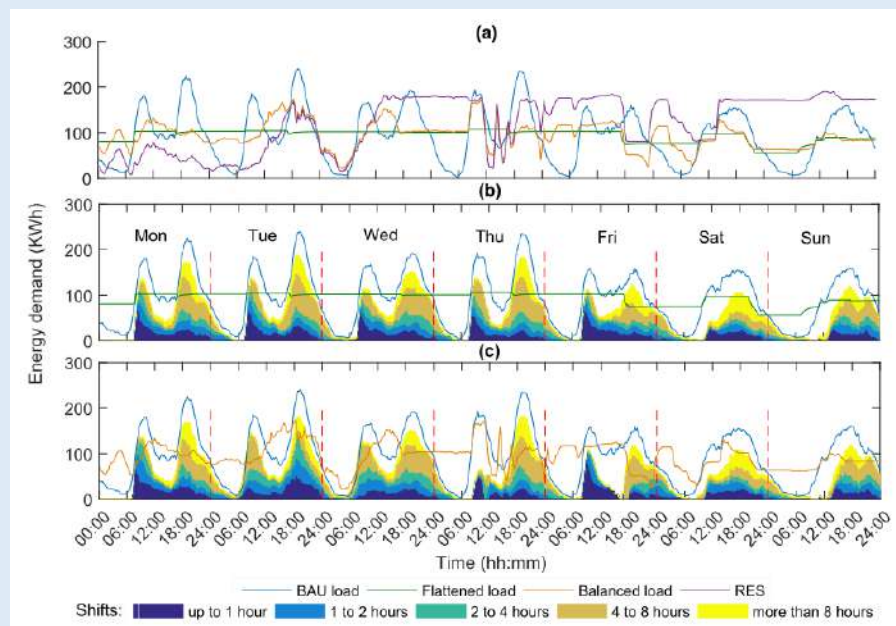

Figure 5.8: a) Load and RE generation patterns, b) Amount of energy that is shifted for load flattening scenario, c) amount of energy that is shifted for load balancing scenario (Sadeghianpourhamami et al., 2018)

5.5.3 Security architecture for electric vehicle charging

The recommended security architecture (set of technical security measures) for EV charging infrastructure is provided in (ElaadNL, 2019b). This helps CPOs (charging point operators) to mitigate cyber-attack risks. Cyber-attacks on grid operators disrupt the grid. Gaining control of CPOs infrastructure, charging station power can be switched on could cause supply-demand imbalances, possibly, power outages. The security architecture is aligned with the ISO/IEC

270001:2013 standard, which helps secure EV charging infrastructure. The internal working of the EV charging station is not considered in the architecture.

Risks mitigated:

Protection against,

1. Attempt to sabotage the electrical grid
2. Large scale fraud and physical attacks
3. Advanced attackers (professional criminal group)
4. Insider threats through logging and monitoring

Building a new system with security architecture as a part consists of,

1. Performing security risk assessment
2. Designing the security architecture
3. Derivation of security requirement for components
4. Component testing and System testing

To ensure the delivered system is secure, the above steps are followed.

Access control:

The security architecture supports access control by allowing all user groups to manage access rights and implement authentication.

CPO central system:

The access rights are managed by the CPO such that implementation of the principle of least privileges is done by the CPO as highlighted in Table 5.2.

Table 5.2: Security and access to the CPO central system

User	Required access	Interface
Engineer	Remote maintenance to charging stations through the central system	Management portal
Customer service representative	Fix customer problems with charging stations	Management portal
Market parties (mobility service provider, roaming platform, TSO, or DSO)	<ul style="list-style-type: none"> • Exchange transaction data • Enable EV drivers to use charging stations from different CPOs 	Market interface

	<ul style="list-style-type: none"> • Provide smart charging schedules 	
Administrator	<ul style="list-style-type: none"> • Maintain applications • Maintain network and server infrastructure 	Server maintenance interface

Charging station:

The charging station manages access rights in such a way that the CPO can implement the principle of least privileges as given in Table 5.3.

Table 5.3: Access rights to Charging station and interface for communication

User	Required access	Interface
Charging Station Management System (CSMS)	<ul style="list-style-type: none"> • Gather information • Manage configuration • Update firmware 	WAN
Engineer	<ul style="list-style-type: none"> • Manage configuration Update firmware • Gather information for fault analysis 	Local maintenance
EV driver	<ul style="list-style-type: none"> • Authenticate for charging Optional: Pay for the charging 	Authentication terminal
Electric vehicle	<ul style="list-style-type: none"> • Control the charging authenticate for charging Optional: 	Electric vehicle
Other charging station	<ul style="list-style-type: none"> • Load balancing within a charging plaza 	LAN
Local EMS	<ul style="list-style-type: none"> • Energy management within the local context (e.g., building) 	LAN

Cryptography:

Applications/measures of cryptography include,

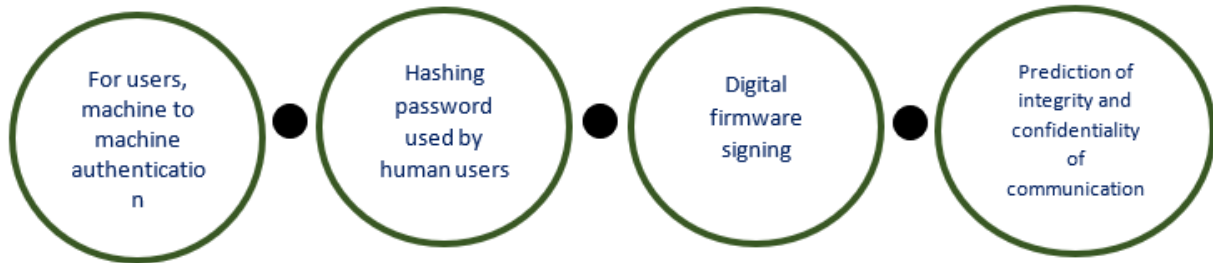

Cryptography is protected using robust cryptographic algorithms and keys. To resist the attack, key lengths and other parameters are chosen, and a cryptographic pseudo-random number generator is used for security by generating random numbers.

The CPO can update keys used on the EV charging station with a cryptographic random number generator, and confidentiality is protected for both passwords and keys.

Physical and environmental security:

The perimeter defense of data centres and tamper detection on the charging plaza and stations provide security against physical attacks.

Secure areas:

The CPO central system's servers are housed in a secure data center that is shielded from advanced physical attacks. For the charging plaza, the tempering is detected when a casing is opened by creating a log event.

Equipment:

To counter the fraud, the EV charging station has a casing that is temper resistant and will create a log if any part of it opened. The casing has to be opened to access the local maintenance interface.

Operations security:

To keep charging infrastructure safe, operational procedures and processes are supported by security architecture.

Operational procedures and responsibilities:

To have future-proof hardware, enough computing power and memory reserves are needed for security updates at the EV charging station.

Backup:

As the charging stations do not store business-critical information in case problem factory defaults can be restored. Also, the automatic backup process is used to support backup and recovery for servers.

Logging and monitoring:

All the events are logged in to gather the information for analysis, including access control events, security setting change events, firmware or software change events, and possible attack signs. The security logs are protected by restricting access to authorized users and implementing a rolling security log.

Control and operational software:

All the operating systems and application software are updated to apply the security updates that verifies the authenticity of the software installed. The software can be updated remotely by CPO as they become available. The digital signature of the vendor is verified with the private key before firmware installation.

Technical vulnerability management:

The unneeded functions are disabled, like closing the unused network services, disabling externally accessible hardware, and removing unused user accounts to support vulnerability management. All The input data is validated at the EV charging station. Hardware-assisted measures are used against exploits to make it more difficult.

Network security management:

The confidentiality and integrity of the communication are protected cryptographically. The firewalls are placed on network boundaries, and wireless access to charging stations is restricted to do the same.

The confidentiality and integrity of the communication on the management portal, WAN interface, market interface, server maintenance interface is protected using cryptographic measures. The network perimeter is protected by placing the firewalls across the network and only allowing regular operation communication. Wireless communication is restricted using a strong password

for local maintenance. The charging stations should not become unreachable or reboot or crash, but they may slow down.

Impact of Smart Charging on EVs charging behavior

An anonymous data set of more than 10,000 charging sessions (2018) in the Netherlands was analyzed to determine the charging patterns of EV users (Refa & Hubbers, 2019). The dataset includes the complete charging records per user for a total of 140 EV user.

The total number of charging events in the dataset can be categorized into two categories.

- **Smart Charging Sessions:** 69% of the total charging session in the dataset were smart charging sessions
- **Regular Charging sessions:** 31% of all charging sessions were regular charging sessions in which the EV user overrides the smart charging option.

The year wise charging transactions have been shown in Figure 5.9.

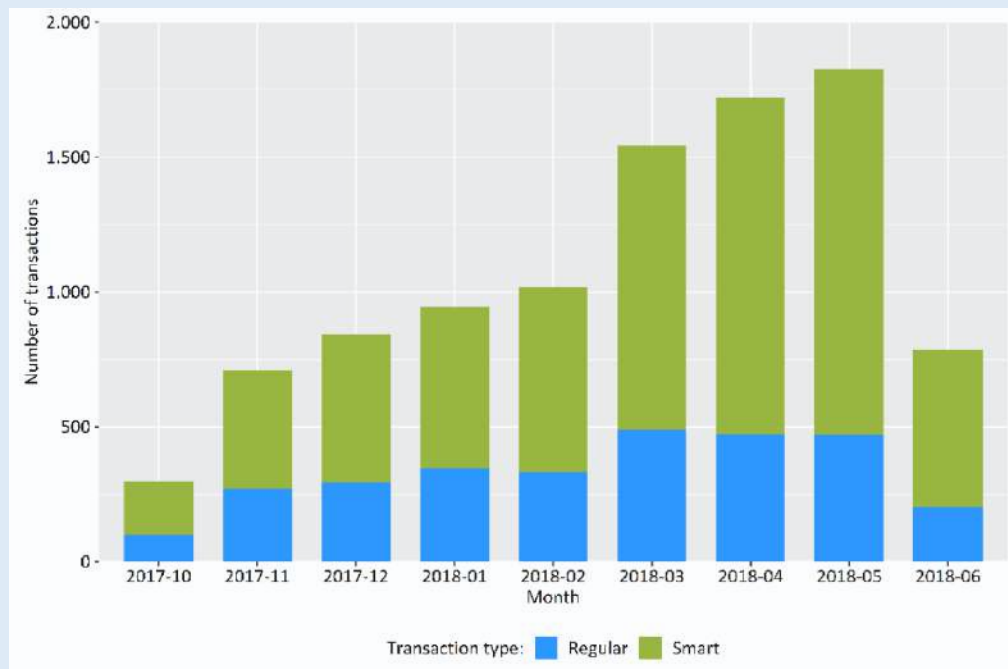

Figure 5.9: Share of charging sessions per month (Refa & Hubbers, 2019)

The energy drawn per charging session is determined by the state of charge of the battery when it is plugged in to the grid. The mean SoC level and the standard deviation at the time of arrival for different locations have been given in Figure 5.10. As seen the EVs connected at home or in office have a mean starting SoC of 50%, but EVs connected at the public fast chargers have a mean starting SoC of 38%. So, it can be concluded that EV users do not generally wait for their EVs to have low SoC values before charging.

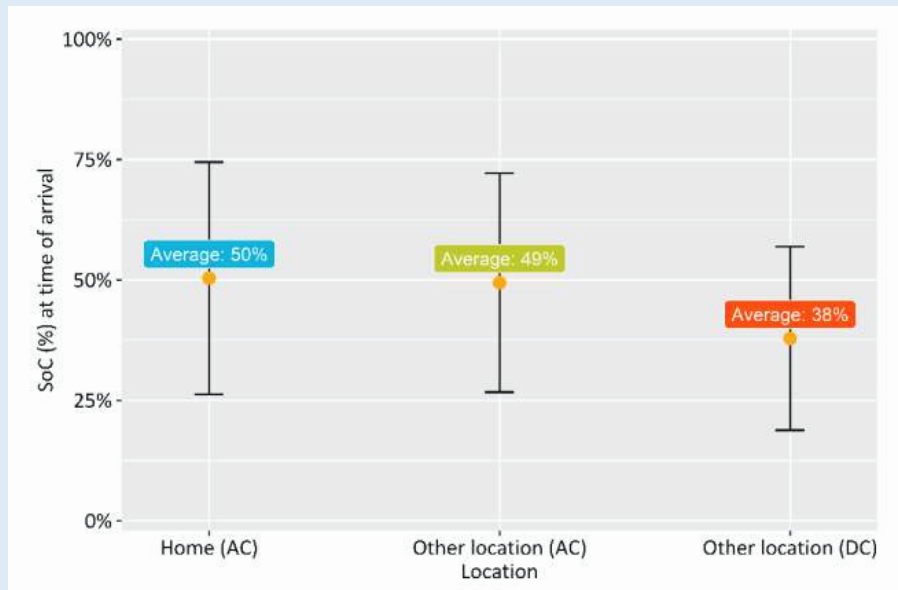

Figure 5.10: Initial SoC for each location (Refa & Hubbers, 2019)

Looking at the impact of smart charging on the hourly energy needs it can be observed that smart charging increases the energy used during the midnight off peak periods while reducing the energy drawn during the peak periods. This has been shown in Figure 5.11. where it can be seen that the energy drawn in evening peak (between 18:00–21:00 hrs.) has been reduced by 47% compared to regular charging.

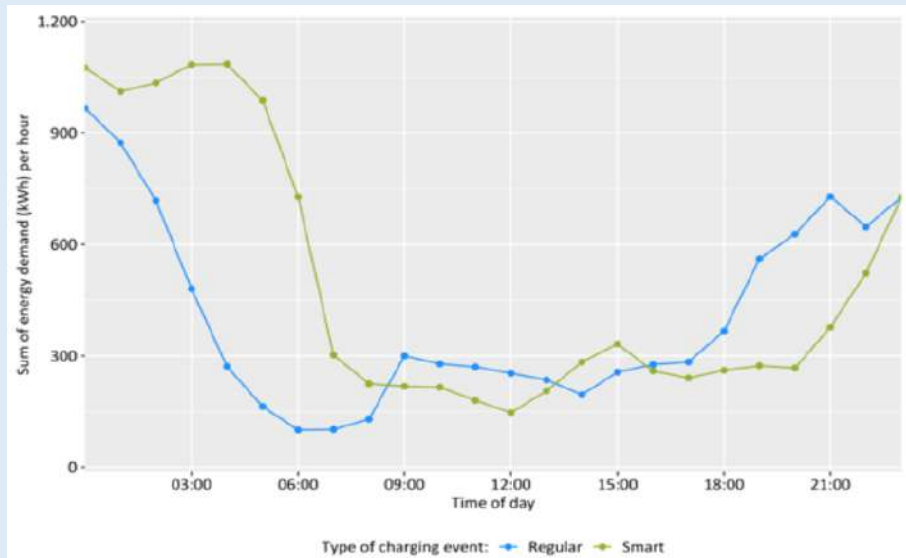
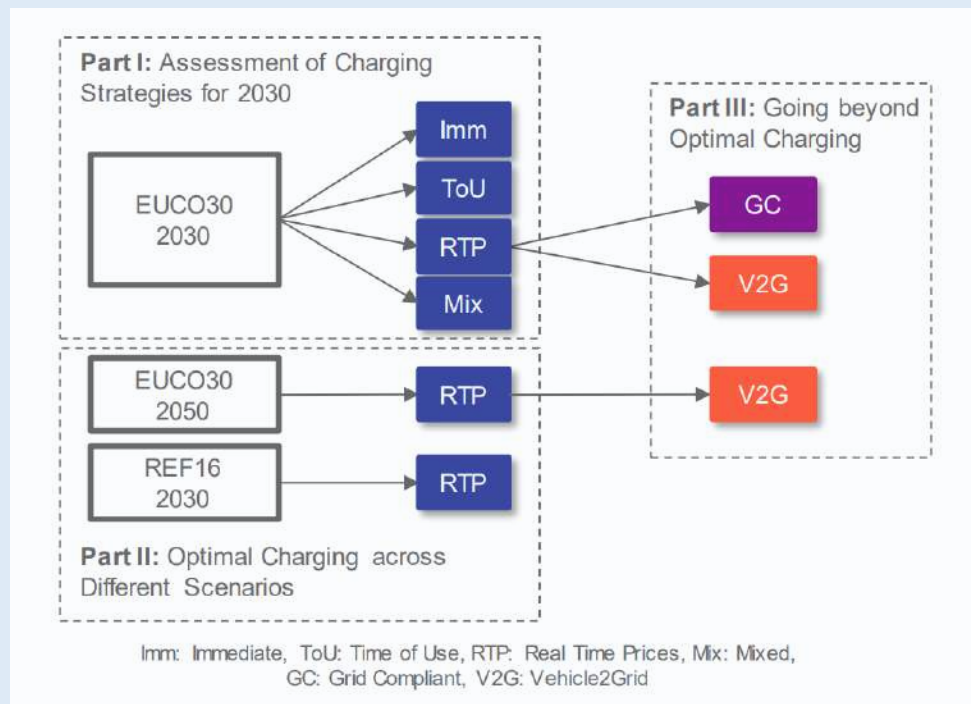

Figure 5.11: Impact of smart charging on energy used per hour (Refa & Hubbers, 2019)

Study on effect of electromobility on the power system and the integration of RES**Project Category:** Research Study**Project Aim:** The project aimed to study the impacts related to the increasing share of electric vehicles on the power system and evaluated different EV charging strategies using the METIS EU power system model (Klettke & Mose, 2018).**Project Overview:**

The study covered the European Union and six neighboring countries (Norway, Switzerland, Bosnia and Herzegovina, Serbia, FYROM, and Montenegro).

Figure 5.12, illustrates the dimensions investigated in the study which were assessed according to key performance indicators such as expected energy not served, peak load, marginal costs, CO₂ emissions and curtailment. The three parts of the project compare the immediate, time-of-use, real-time price-based and mixed charging strategies.

**Figure 5.12: Overview of dimensions investigated in the study (Klettke & Mose, 2018)**

The different charging strategies were integrated into the simulation of the power system using the METIS model. METIS is a mathematical model providing analysis of the European energy system for electricity, gas and heat.

Project Results:

Figure 5.13 shows the impact of the RTP-based charging on the power plant correlates with the share of EV demand. Projections for 2050, indicate an important potential of flexibility for the power system is given by the EV fleet.

The study concluded that V2G adds storage capacities to the power system and facilitates variable renewable energy sources integration resulting in a reduction of curtailment (nearly 20% in 2050 for EU28 as well as EU28+6 countries)(Klettke & Mose, 2018).

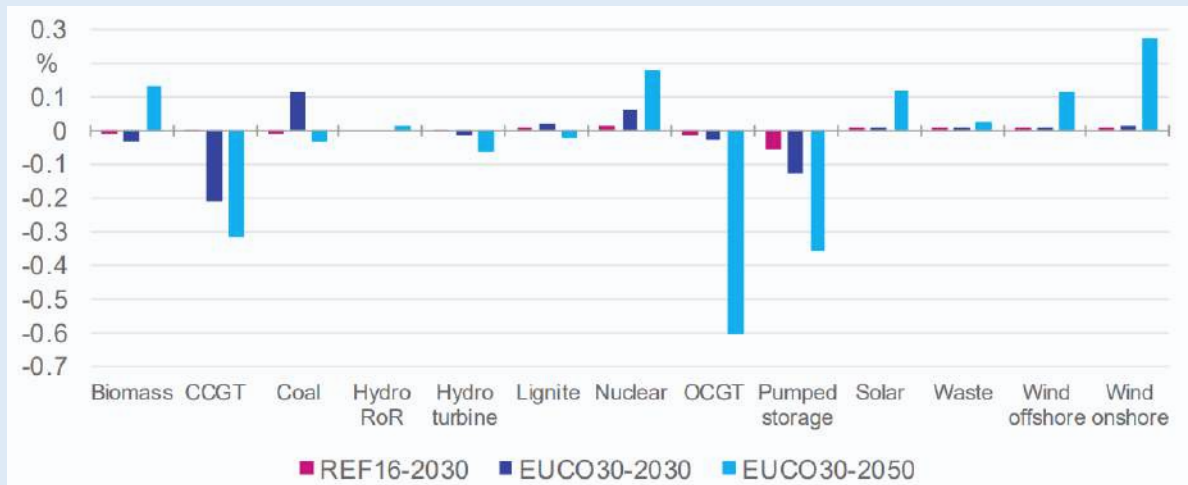

Figure 5.13: Difference in generation between RTP- and base scenario for EU countries (Klettke and Mose 2018)

Key Learnings:

The study put forward the following recommendations.

- Introduction of Time-of-use tariffs to avoid negative impacts resulting from uncoordinated EV charging.
- Aggregators should be introduced to ensure system-compliant integration and bundle the load of all flexible consumers in order to establish real-time pricing for final costumers themselves.
- Ensure the roll out of enabling technologies such as advanced metering infrastructure establishment of secure data exchange and storage in order to address consumers' privacy and data protection.
- Electric vehicle smart charging should be considered as a resource of system flexibility for RES integration by making use of the EV batteries as important system storage potential.

5.6 Case Studies

5.6.1 Interflex project (Dutch demonstrator)

The Interflex project consortium investigated the use of local flexibilities to relieve distribution grid constraints using including e-mobility.

Project Category: Pilot project

Project Aim: To develop insights into the market and development potential of the investigated innovations including managing grid congestion so as to avoid grid reinforcement in a context of constraints caused by increased share of renewables and deployment of EV charging infrastructure.

Project Duration: 2017-2020

Project Overview:

As part of the Horizon 2020 Research and Innovation Program of the European Union, the Interflex project includes six demonstration projects conducted by five distribution system operators (DSOs) in several European countries. Six industry-scale pilot projects were set up in Czech Republic, France, Germany, The Netherlands, and Sweden

The Dutch pilot project is conducted in Eindhoven and focuses on the integration of local battery storage in the electricity network, several public charging facilities for EVs. The demonstration explored three use cases:

- Provision of grid support services such as ancillary service, congestion management, voltage support for PV integration using varied storage systems.
- Enabling the optimal activation of all available local flexibilities offered by the locally installed EVSE's for congestion management.
- Validating technically, economically, and contractually the usability of an integrated flex market based on a combination of static battery storage and EV chargers.

A commercial aggregator (CA) combines multiple short-duration flexibility sources for participation in an electricity market as a demand service provider. The local authority (LA), in turn aggregates local flexibility resources to a bigger flexibility offering. The LA provides the flexibility to a CA on a contractual basis. The electricity operator in Netherlands, Enexis requests these aggregators to offer the required flexibility.

Flexibility Aggregator platform (FAP) obtains forecasted impact on distribution grid from DSO. FAP in association with Local Infrastructure Management Service (LIMS) handles the requests from CA & LA. The project used forecasting tools on DSO and Flexibility Aggregator platform (FAP) to determine the expected impact on the distribution grid. First, the grid impact of EV charging and increased share of renewables is forecasted, after which a request for flexibility services is sent via the IT platform to FAP. This request details the required upward or downward balancing services for frequency response as well as the price to be paid for a given congestion point and the corresponding time slot. Aggregators then evaluate corresponding availabilities and send bids based on their flexibility resources. Flexibility resources utilized in this pilot project comprised of a stationary battery, a controllable PV system as well as smart functions to manage the charging sequence of EVs in the demonstration area. Based on the current situation DSO will opt an intelligent solution to connect at Point of Coupling (POC). At POC the net energy is metered. The architecture described above have been represented in Figure 5.14

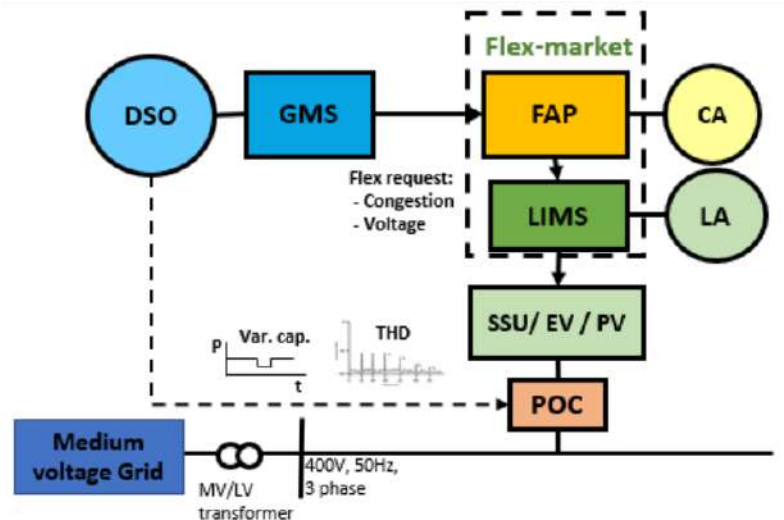

Figure 5.14: Architecture of the project (InterFlex, 2020)

Type of Chargers used:

Each station consists of two sockets, each with a maximum capacity of 3x63 A. The charging capacity is always optimally divided among the sockets in use. The connected LV cable to the charging station has a maximum capacity of 173 kVA. So, if all charging stations are occupied, the cable might be overloaded. Therefore, a smart charging logic has been developed to prevent load congestion situation.

Communication Method/Technology used:

Enexis DALi (Distributed Automation Light) system is responsible for collecting the grid data from the measurement devices installed at the Medium Voltage (MV)/Low Voltage (LV) station.

Key observations:

Three use cases tested in this project provided practical experience in understanding how a DSO can use flexibility to develop a cost-effective grid infrastructure. The project successfully established flexibility mechanisms and defined the roles of the respective stakeholders. A key feature of the project was development of innovative flexibility products for aggregators that were compatible with DSO flexibility requirements and market rules. Knowledge obtained from this project also will enable to create scalable and positive business cases for all stakeholders.

5.6.2 Project Frequency Containment Reserves (FCR)

Project Category: Pilot project

Project Aim: The main objective was the examination of barriers and technical viability to enter the FCR market with of technologies which are newly arrived in FCR market.

Project Duration: January 2016 - June 2018

Project Overview:

The FCR project was initiated to investigate the extent to EVs could support Tennet's primary reserve market. Figure 5.15 below illustrates the prequalification process which considered several issues including, insufficient delivery of FCR during one or more subtests, non-complete or non-synchronous execution of prequalification tests, unclear reporting, and varying data formats.

The power must be delivered for 15 mins post-test. The tests are the following:

- a For simulated frequency deviation of 200mHz, transition of power from minimum net to maximum net should be obtainable within 30 seconds.
- b Similarly for -200 mHz simulation, same amount of time must be taken to reach from maximum net to minimum net.
- c For simulated frequency deviation of 100mHz, transition of power from minimum net to maximum net should be obtainable within 15 seconds.
- d Similarly for -100 mHz simulation, same amount of time must be taken to reach from maximum net to minimum net.
- e For the power setting stated under a), For a simulated evenly increasing frequency deviation of 0 mHz to +200 mHz., full power decrease must be followed within 2 minutes. Maximum 30 seconds time lag on simulated results is allowed.
- f Similar changes are to be seen in negative frequency deviation i.e., 0mHz to - 200mHz with same time requirements and allowed time lag.

Post completion of above tests, the technical team must ensure the frequency for 8 hours and find the corresponding measurement strips. For fine frequency support, last test results are necessary to validate

the quality of frequency support. Test results are to be shown to fulfil prequalification. These are required as follows:

- Measurement results and protocol
- Precise test setup containing structure, specification, and measurement points.
- List of performed tests and time to be taken
- Procedure for testing
- Testing person and contact person

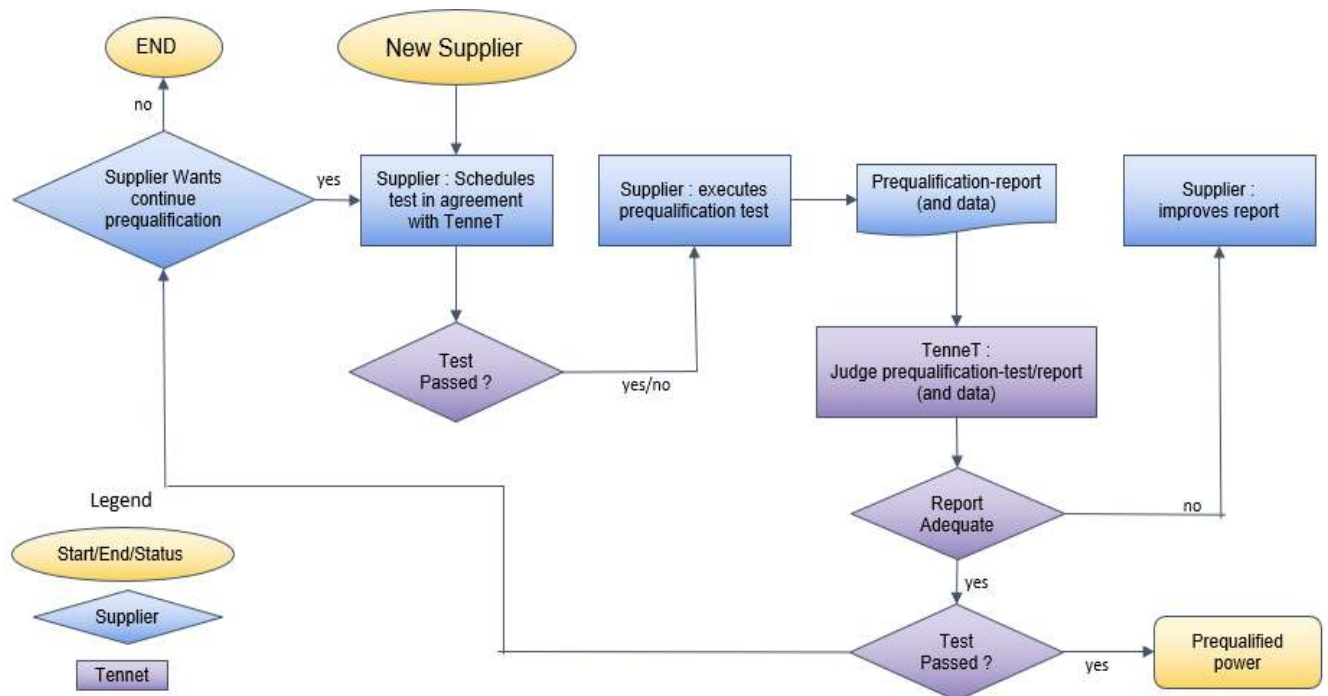

Figure 5.15:Pre-qualification process in project FCR, Source: (InterFlex, 2020)

Figure 5.16 illustrates the daily operation of the pilot. Pilot participants were required to submit the planned volume to be delivered one week in advance. By nominating, the allocation was implicitly provided and from the regular market, bid size and requirement of power did not match.

In case non-conformities, the settlement and incentives were determined other than normal operation. The remuneration for pilot participants was done according to average Dutch auction price. Within the synchronous area, non-conformities were not paid as the FCR delivered during the pilot, was complementarily to Dutch obligation. Observing the FCR conveyance was done ex-post utilizing information sent by the pilot members through email, which is another distinction to the normal market. The ex-present information was breaking down on decide whether the distributed FCR was conveyed accurately. At the point when an issue happened, it was accounted for to the pilot member for additional investigation and

clarification. The pilot members utilized this data additionally as contribution to improve the nature of the FCR conveyance.

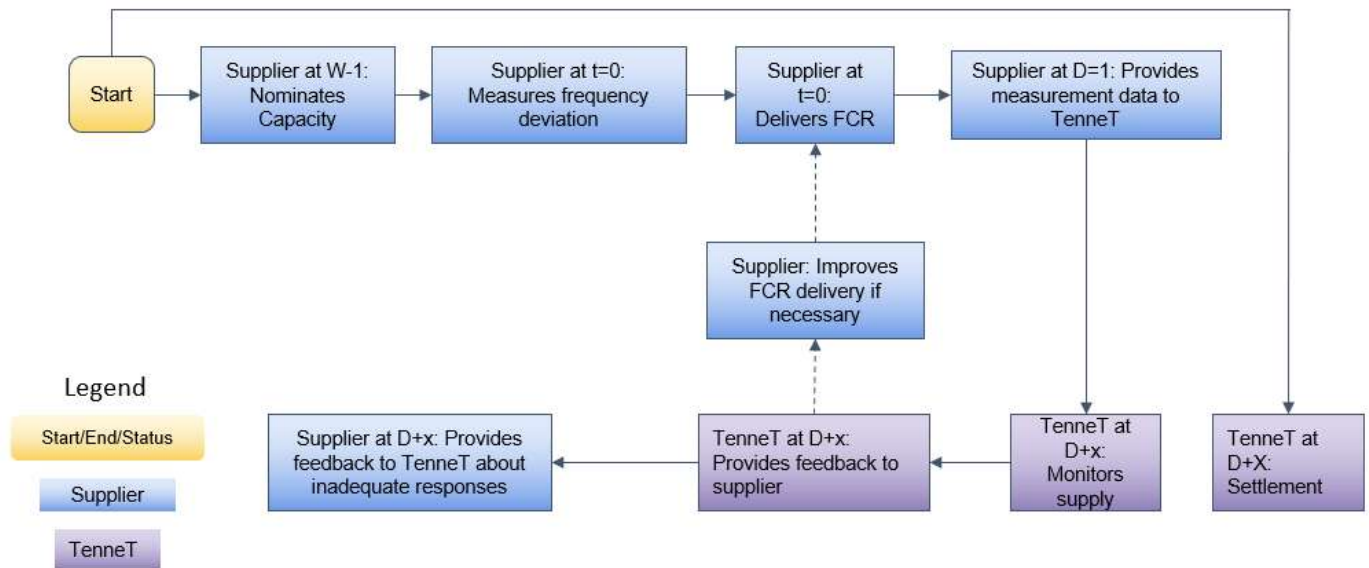

Figure 5.16: FCR project operation, Source (InterFlex, 2020)

Service requirements in pilot:

As a global Energy and service group, ENGIE proposes to aggregate a variety flexible asset that cannot comply to the FCR requirements individually due to size (<1MW), flexibility characteristics (mainly speed and precision) and/or reliability.

KPN is a telecom organization which had a few resources for be utilized for society advancement. Subsequently the essential idea was to re-utilize KPN's current resources for offer the assistance to TenneT. These resources basically comprise of rectifiers (48Vdc) and batteries (Pb-acid, OPzS).

NEWMOTION introduced uncommon V2G chargers fit for charging and releasing electric vehicle (EV) batteries to research whether EV's joined with exceptional equipment can give FCR successfully.

PEEEKS creates keen control answers for request side administration of electric devices.

SENFAL created collection innovation that can pool charging stations of electric vehicles, private energy stockpiling and wind turbines to convey essential stores. SENFAL effectively conveyed FCR with batteries and charging stations of electric vehicles and are currently increasing their exercises.

Charger Specification: The V2G chargers utilized in the pilot are 10 kW bi-directional AC to DC converters interfacing straightforwardly to the high voltage DC transport in the EV, henceforth offering direct control of the energy stream. Vehicles utilized were Mitsubishi Outlanders transcendentally, at the two workplaces as private areas. Accumulation programming and administrations were given by Nuvve running their product in the cloud just as on the V2G chargers.

Project Results: During the FCR pilot project Senfal created conglomeration innovation that can pool charging stations of electric vehicles, private energy stockpiling and wind turbines to convey essential stores.

SENFAL effectively conveyed FCR with batteries and charging stations of electric vehicles and are currently increasing their exercises. The task likewise recognized the principal boundaries to take an interest in the standard market end up being a constant information correspondence with a rented line and the estimations prerequisites for a pool.

Learnings: The recognizable proof of obstructions to advertise cooperation brought about the improvement of a web administration for FCR information conveyance and changes in the item details. Furthermore, the total FCR portrayal and FCR prequalification measure were changed to data for the growing business sector.

The subsequent composed FCR manual for gives more subtleties on the meaning of a save giving gathering, item particulars and operational information trade. The accompanying exercises are drawn:

- Prequalification tests demonstrated to require significant exertion from both TenneT and provider
- Reviews are additional tedious than expected and include NDAs to ensure the licensed innovation

Setting up another information association end up being more far reaching than expected

5.6.3 Wireless Charging in Rotterdam

Project Category: Pilot Project

Project Aim: The objective of this project was to identify the technical, organizational, and environmental implications of wireless charging of EV.

Project Duration: 2015-2017

Project Summary:

This project's primary goal is to show that wireless EV charging is possible at public EV charging stations (Elfrink et al., 2017). Nissan Leaf was chosen for the pilot testing project equipped with a wireless charging receiver. The wireless power transmitter in the ground with a 3-kW charger wirelessly charges the EV. Though wireless EV charging is user-friendly, one of the reasons wireless charging technology is not available readily is due to a lack of standardization.

To enhance existing infrastructure and facilitate future electric transport, charging cable, a major practical and technical obstacle, must be mitigated. Currently, Netherland has more than 115000 EVs on-road and around 30000 installed public and semi-public charging points.

The project's objective is to identify the environmental, technical, and organizational implications of wireless EV charging. The project information can be used for developing standards for wireless EV charging, further capability development, and possible expansion.

Table 5.4: Consortium entities and their role

Entity	Role
City of Rotterdam	Project management and location management
ENGIE Infra & Mobility	Install and service wireless EV charging system
EV-Box	Delivery and operation of the wireless EV charging system
Technical Expertise Centre ANWB	Vehicle adaptation
ElaadNL	Investigate the suitability of the system
EVConsult	Project manager

Challenges:

Several technical challenges, including hardware and software issues, system repair, system upgrade, etc., were experienced in implementing a wireless EV charging system. Hardware was still in the development stage while integrating the system on-site, which resulted in technical difficulties and integration delays. Due to the issues in the software protocol implementation, the transactions were not delivered, and the system was separated from the office for remote monitoring.

There was uncertainty regarding EMI/EMC tests while charging, and the emissions may cause disturbance on the system. For these experiments, the inside of the vehicle was shielded, and the hardware was repositioned. The overall system faced overheating, and the onsite inverter overheats at 65 °C in 45 min of charging, so active cooling was implemented.

Wireless Charging:

HEVO WPT (Wireless Power Transfer) transfers energy by a non-radiative magnetic field to EV. HEVO Power's technology uses magnetic resonance to match the resonant coupling of the HEVO transmitter in the ground and the vehicle receiver, allowing for the most efficient wireless power transfer possible.

The Wireless EV charging system has a rectifier, Power Factor correction (PFC), inverter, transmitter, receiver. On the transmitter side, the rectifier converts AC from the grid to DC and

feeds it to the inverter to convert DC into high-frequency AC to transmit it. A large capacitor is connected to the rectifier to maintain a constant voltage. The PFC module in the form of a DC-DC converter connected to mitigate harmonics and reactive power flow to the grid due to capacitor and adjust the power factor close to unity.

The inverter (composed of diodes and MOSFETs) is connected to the transmitter, a large coil (similar to the air-core transformer) embedded into the paving or surface mounted. The inverter switches are controlled using phase control to regulate the power flow in the system.

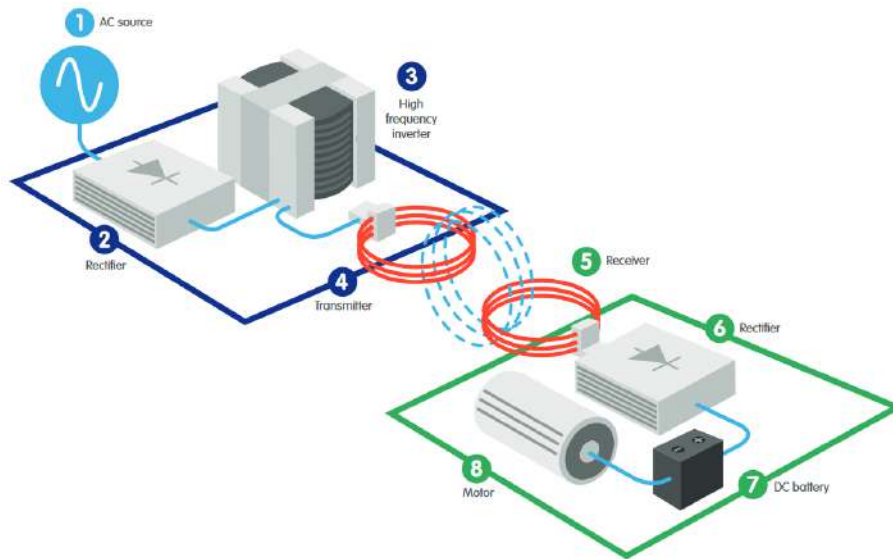

Figure 5.17: Component of wireless charging (Elfrink et al., 2017)

The receiver also has a coil installed in the chassis of the vehicle connected to the rectifier. The rectifier interfaced with a battery management system (BMS) converts high-frequency AC into DC to supply batteries. The rectifier (with receiver) has an efficiency of 85 %- 92 %.

System operation:

A secondary coil, rectifier, and a communication module are installed in the vehicle to facilitate wireless charging. The perfectly positioned secondary coil receives power from the primary coil which is rectified by the rectifier to charge the battery. Bluetooth establishes the communication between EV and EVSE. The rectifier is placed behind and in series with the secondary coil. The DC fast charging socket remains no longer functional during wireless charging. The communication line is wrapped around the ferrite core to eliminate the induction system noise and

maintains the input/output functionalities. A 12 V battery system through 5 A- 10 A fuse is used to power the rectifier control system.

The onboard charger will prioritize the charging option when parked at a wireless EV charging station with an AC cable inserted. The charging system had a challenge in EV charging due to onboard chargers' different operations and functionality. The charging controller had to be programmed to prevent the charging session from terminating. The car manufacturer requires communication, operation, and functionality protocols to ensure a smooth charging operation.

Wireless EV charging standards are defined in IEC 61980, which covers general requirements, communication, and magnetic fields power transfer.

The power and air gap clearance classes used in the wireless charging are summarized below in Table 5.5 and Table 5.6 respectively.

Table 5.5: Power classes and power rating

Class	WPT1	WPT2	WPT3	WPT4
Power (kW)	3.7	7.7	11.1	22

Table 5.6: Air-gap clearance classes

Class	Z1	Z2	Z3
Clearance (mm)	100-150	140-210	170-250

The EV and EVSE should support the same power class and clearance class for interoperability. The system's efficiency measured to be 85 %- 92 % showed that wireless charging is more efficient than plug-in charging. The loss percentage during peak efficiency (92 %) is summarized in Table 5.7. The airgap significantly affects the system efficiency, reducing the airgap affects the switching losses, and increasing the airgap makes the coupling weaker, and hence power transfer decreases. The misalignment of transmitter and receiver results in lower efficiency; thus, alignment is essential for maximum system utilization.

Table 5.7: Wireless charging system loss components

Loss component	EMI filtering	Resonant coupling	AC/DC conversion	PFC	DC/AC conversion
% Loss	1	2	2	1	2

Smart charging is possible with a dynamic inverter control algorithm to achieve different charging levels. Communication helps coordinate EV and EVSE for better control to achieve the required power level for EV charging. The transactions are initiated using an RFID card at EV-Box RFID reader.

OCPP communication protocol is used to exchange the real-time charging information (power factor, efficiency, coupling factor, etc.) between EVSE and CPO. In terms of electromagnetic interference, radiated emissions and conducted emissions are analyzed to get insights into electromagnetic challenges. Radiated emissions were 58 dB higher than allowed, and conducted emissions were 50 dB higher than allowed. The electromagnetic field analysis shows that the intensity is within acceptable limits as per 2013/5/EU guidelines. In conclusion, Wireless EV charging is entirely safe.

Chapter 6. Germany

6.1 Background for policy making environment

German EV charging infrastructure policy is addressed at both national and regional level. The national government sponsors projects related to EV charging infrastructure while local and regional authorities provide co-financing of projects. The market incentive package considers three measures with a financial impact, i.e., temporary purchase incentives, the expansion of the charging infrastructure, and the purchase of electric vehicles by public authorities.

The Federal Network Agency (BNetzA) is the German regulatory agency for electricity, gas, telecommunications, post, and railway markets. The agency falls under the German Federal Ministry of Economics and Technology and is the regulatory authority the charging station ordinance. Other key stakeholders in EV charging policy include the National Platform on Electric Mobility, the Federal Ministry for Economic Affairs and Energy, the Federal Office for Economic Affairs and Export Control and the German Association for Energy and Water Management (BDEW).

6.2 EV Charging infrastructure policies and regulation

Policies Enabling EV charging on supply-side		
Element	Policy Instrument	Measures
Definition of a fundamental market design framework to limit distortions and entry barriers	Low-Voltage Grid Connection Ordinance (Niederspannungsanschlussverordnung)	Regulates the influence of Distribution System Operators (DSOs) on the approval of new charging stations and states that installations without DSO approval are not permitted.

The incentive for launching the EV charging market	Climate Action Program 2030	<ul style="list-style-type: none"> • A target of one million charging stations is to be available by 2030. The German government will promote the development of a network of public charging stations by 2025, and produce a master plan for the charging station infrastructure • The aim of the German government is to have 1 million public charging points available by 2030 and to invest more than INR 26,424.1 crore (EUR 3 billion) in charging infrastructure for cars and trucks by 2023 and an additional INR 4,404 crore (EUR 500 million) in the expansion of private charging facilities (ICCT, 2020).
	Electric Mobility Act	Enables municipalities to grant preferential treatment to BEVs and PHEVs particularly in terms of parking and the use of bus lanes.
Prioritization in terms of EV characteristics and social geography	Regional policies	The cities of Hamburg and Berlin have produced specific models for EV charging infrastructure deployment within their jurisdictions.
	Federal Building Code (Baugesetzbuch)	<p>Defines the principles and procedures to be followed by municipalities in drawing up land-use plans which are to include EV charging infrastructure.</p> <p>Also specifies situations in which a permit is not required for a new charging station. (Venselaar et al., 2019)</p>
Elimination of administrative barriers for establishing charging stations	Climate Action Program 2030	The legal provisions regarding the installation of charging infrastructure are to be simplified in the Act on the Ownership of Apartments and the Permanent Residential Right (Wohneigentumsgesetz, WEG) and in legal provisions governing renting properties. Landlords will be required to tolerate the installation of charging infrastructure.

Mandate on user data sharing and privacy	The Charging Station Ordinance (Ladesäulenverordnung)	The register data published on the charging station card and in the list are freely available to the public and can be downloaded and saved free of charge. The Federal Network Agency accepts no liability for the correctness and completeness of the data.
Mandate on utilization of V2X services	Energy Industry Act	Established preconditions for grid charges to be reduced where electric vehicles are used to support the grid.
Policies Enabling EV charging on demand-side		
Element	Policy Instrument	Measures
Technical standardization of chargers for interoperability	Calibration Law and Regulations (Eichrecht)	Sets the requirements to be complied with for the measuring instrument in order to be state-of-the-art to ensure correct measurement results within German Law. ISO 15118 is seen as a long-term solution.
	The Charging Station Ordinance (Ladesäulenverordnung)	<ul style="list-style-type: none"> • Charging stations with a charging capacity < 3.7 kW are excluded from the regulations • Each AC (≥ 3.7 kW) charging station should be equipped with Type 2 connectors in accordance with the DIN EN 62196-2, issued in December 2014. • Each DC charging station with the possibility for AC charging should include conditions specified for each AC charging station. • Each DC (> 22 kW) charging station should be equipped with a Combo 2 connector in accordance with the DIN EN 62196-3 issued in July 2012

The mandate for the development of digital platforms and database management systems	The Charging Station Ordinance (Ladesäulenverordnung)	<ul style="list-style-type: none"> • It intends to enable the unhindered use of EVs across operators, municipalities, and countries. • Operators of publicly accessible normal and fast charging points have to register, and an overview can be found on the Bundesnetzagentur (Federal Network Agency for Electricity, Gas, Telecommunications, Post and Railway) charging point map. • The BDEW Federal Association of Energy and Water Management also offers a charging point register which contains the public and partially public charging points available in Germany.
Specification of the use of a wide range of payment methods	The Charging Station Ordinance (Ladesäulenverordnung)	The charging station ordinance specifies that the EV users will be able to charge their vehicles and pay for the electricity at all publicly accessible charging stations using a common web-based payment system (e.g., an app), or (if available) in cash, by electronic cash (EC) or credit card.
Specification of minimum facilities to be provided at charging stations		The menu navigation for charging should be available in at least German and English
	Climate Action Program 2030	All petrol stations in Germany to provide charging stations on their customer parking areas.
Harmonization of cross-border/cross-provider user registration for accessing charging infrastructure	The Charging Station Ordinance (Ladesäulenverordnung)	EV drivers should be able to charge and pay spontaneously at any time, without any contract with a service provider signed beforehand. The regulation is intended to enable the unhindered use of electric vehicles across operators, municipalities, and countries. The basis for the Charging Station Ordinance is the Energy Industry Law and it regulates the main aspects of operating charging infrastructure, authentication, use and interoperability for AC and DC charging.

Deployment of fast chargers	Schnellladegesetz ("Fast Charging Act")	<ul style="list-style-type: none"> • Creation of a dense fast charging network. • Financing of 1000 fast charging hubs through either CAPEX or OPEX • A budget of INR 17,593 crores (EUR 2 billion) • At least 150 kW (@400 V) for each charge point
-----------------------------	--	--

On the supply side, the German government has enacted the Charging Station Ordinance, thus implementing the EU Directive (2014/94/EU). This directive regulates the establishment of EV charging infrastructure harmonizes socket standards for publicly accessible charging stations. The ordinance mandates the requirements for charging station operation which include informing the Federal Network Agency of new charging infrastructure installation by charge point operators. The main focus is on temporary purchase incentives, expansion of the charging infrastructure, and the purchase of electric vehicles by public authorities. The government has also clearly established, the administrative process in terms of land use for setting up charge points, data sharing portal, pre-conditions to enable V2X services where EV will be used to support the grid. On the demand side, technical protocols needed are to be state-of-the-art, ensuring interoperability across service providers and across geographies. The ordinance issued by the government also mandates data management to help with better planning of the infrastructure rollout. In terms of ease of use by consumers, EV users can charge and pay via multiple payment options at all public charge points.

The sales of all-electric EVs have quadrupled in Germany in June 2021, compared to the same time frame in 2020, with a record 12.2% EVs being sold among all vehicles. The first half of 2021 has seen an increase in these consumers subsidies compared to the entirety of 2020. The country now offers federal incentives of INR 7,32,315 (EUR 9,000) for battery EVs, INR 5,94,236 (EUR 6,750) for plug-in hybrids priced below INR 35,21,401 (EUR 40,000). Additionally, tax exemptions, local incentives, free parking, permission to use bus lanes and subsidized charging options have been put in place, all of which will be extended beyond 2021 but will be lowered in two stages by 2025 (Reuters, 2021).. It was also declared that Germany might surpass its goal of having 7-10 million EVs on the roads.

6.3 EV Charging infrastructure

The Charging Station Ordinance (LSV) provides a map showing the charging facilities of all operators who have fully completed the notification procedure of the Federal Network Agency and approved publication on the Internet. Germany has an ambitious charging masterplan and targets for one million public charge points by 2030 and investing 3 billion euros in infrastructure deployment by 2023.

There are 20,741 charging points of 22 kW rating, which is the most common power output in Germany followed by 11kW EV chargers. There are now nearly 7,500 fast chargers (charging power more than 22 kW) in Germany (IEA, 2020). Rapid charging points of 150kW and 350kW are less common with approximately 450 of them across the country (Moreno, n.d.). Figure 6.1 shows the percentage of charging points according to the power output. Figure 6.2 shows the trend of publicly accessible charges in Germany till 2021.

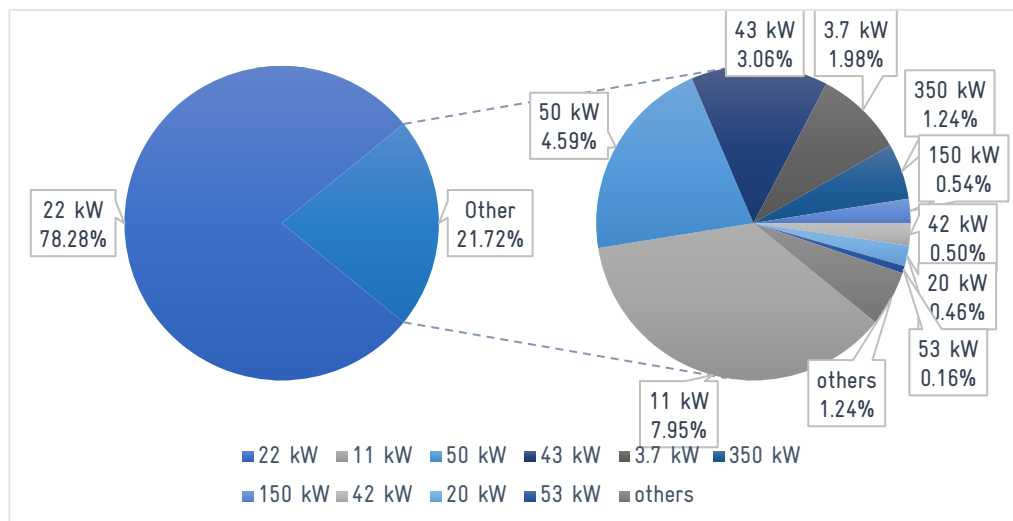

Figure 6.1: Power output of EV charging points in Germany (Moreno, n.d.)

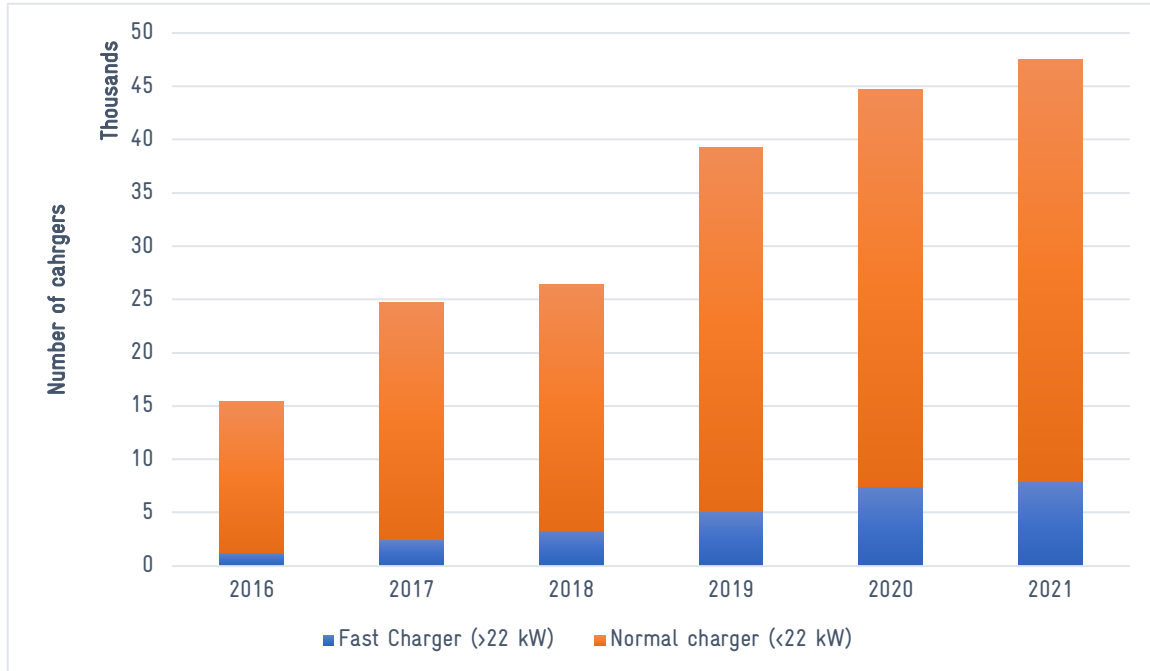

Figure 6.2: Trend of publicly accessible chargers till 2021 (EAF0, 2021)

6.4 EV demand status

Germany has a fleet of 309,083 BEVs and 279,861 PHEVs by the end of 2020 (KBA, 2021)(IEA, 2020). The share of EVs in Germany is growing, with BEVs accounting for 1.8% and PHEVs account for 1.3% of the total market share in 2019 (IEA, 2020). Figure 6.3 shows the registered EVs in Germany according to engine type.

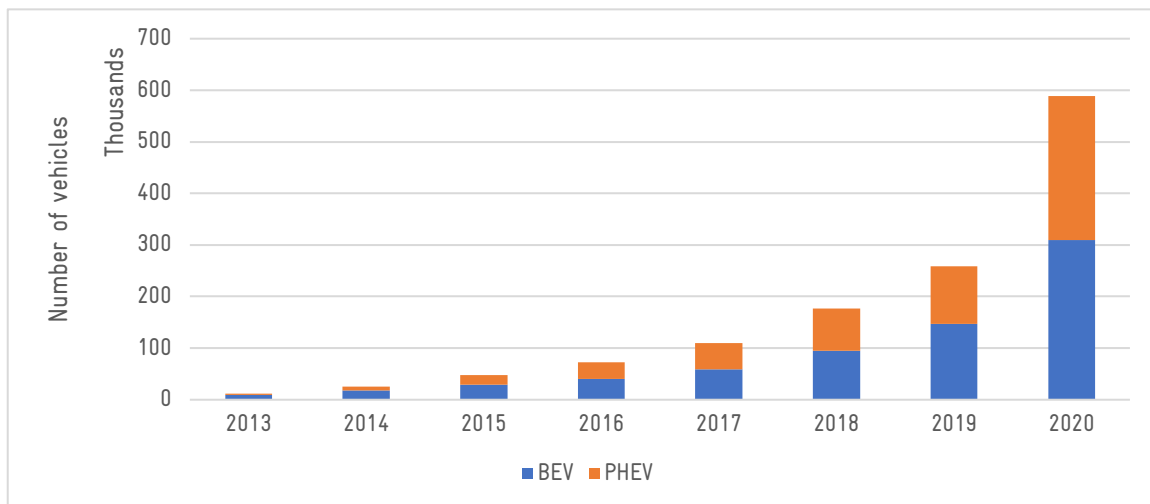

Figure 6.3: Registered passenger EVs by engine type (KBA 2021)

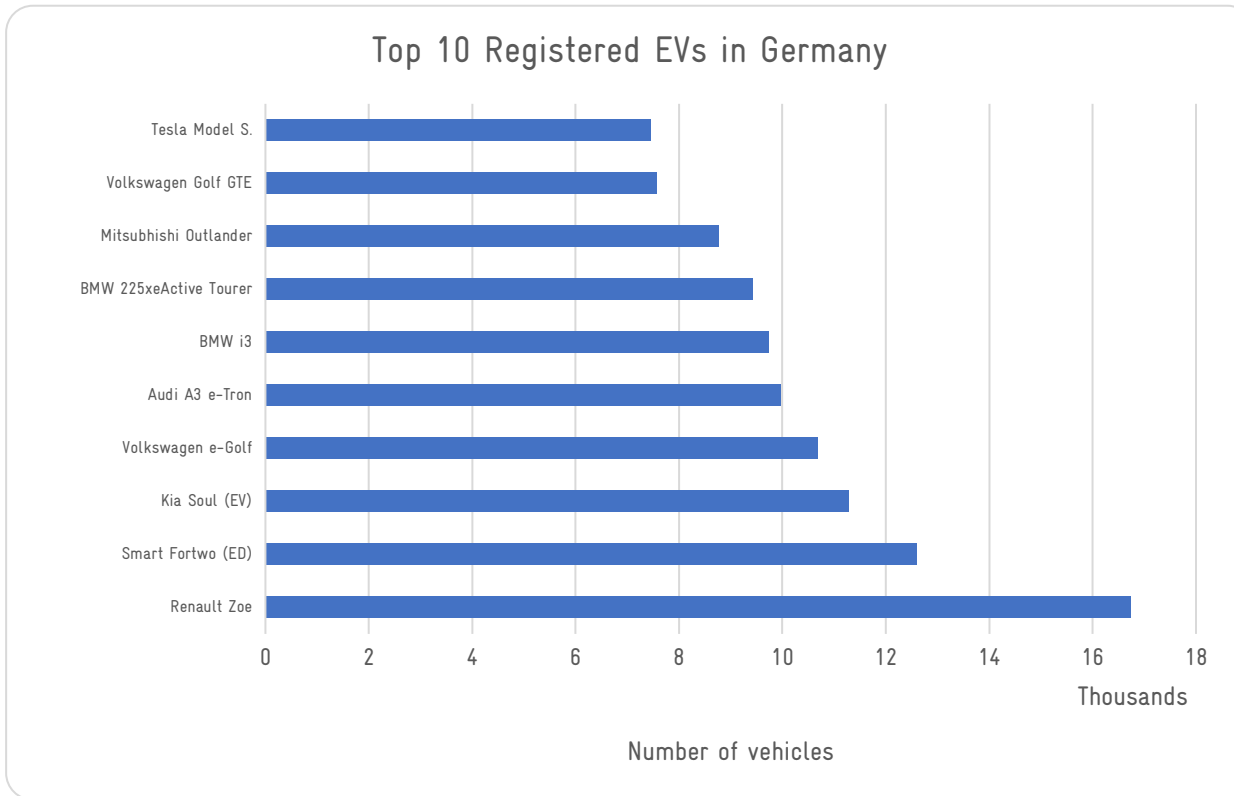

Figure 6.4: Top 10 Registered EVs in Germany

As defined in the 2030 Climate Action Program passed in October last year, the Government aims to have up to 10 million EVs and 1 million charging stations on German roads by 2030. To achieve this ambitious objective, several EV incentives have been extended or added. The top ten EV models in Germany are shown in Figure 6.4.

6.5 EV integration

Figure 6.5 shows the projected growth in intermittent renewable energy generation in Germany. The EV is considered a controllable load by legislation¹³. Which enables DSOs and suppliers to set discounted network charges for EV charging, and in return, DSOs are granted the right to adjust the demand of EV charging point during predetermined peak hours if the distribution network is stressed.

¹³ (Energiewirtschaftsgesetz vom 7. Juli 2005 (BGBl. I S. 1970, 3621), das zuletzt durch Artikel 1 des Gesetzes vom 13. Mai 2019 (BGBl. I S. 706) geändert worden ist, 2005).

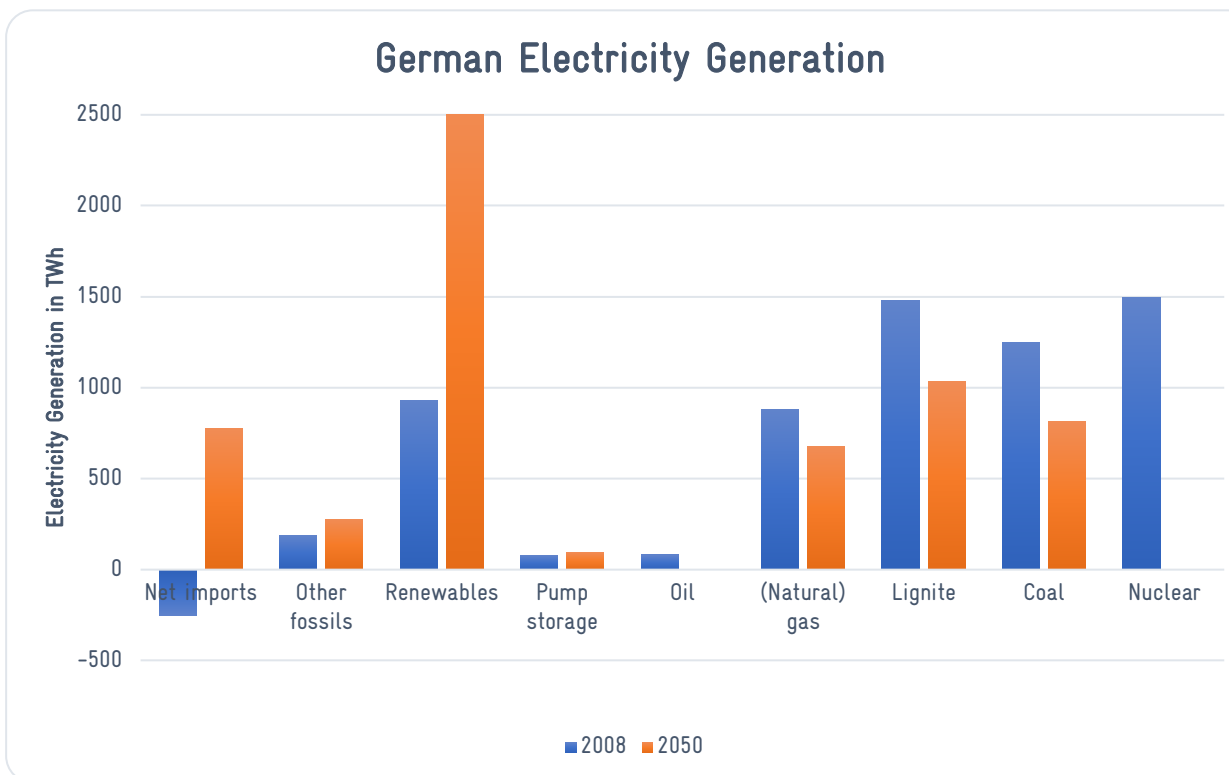

Figure 6.5: Projected electricity generation mix for 2050, (Jochem et al., 2012)

This arrangement allows the DSO to interrupt the EV charging to manage (Bhagwat et al., 2019). The local distribution system operator in Hamburg, Germany concluded that a 9% EV share would lead to bottlenecks in 15% of the feeders in the city's distribution network (Bundestag, 2019). To avoid this, a smart charging solution was adopted.

In order to apply the controllable load tariff, the EV user is required to have a smart meter enabling communication with the DSO and permit interruption of EV charging. The controllable load tariff differs from a standard tariff in two ways, first the EV owner does not pay an annual fixed fee and pays a highly discounted volumetric charge throughout the day. Second, if a DSO interrupts the charging of EVs due to reliability reasons, it resumes during off-peak hours. (Hildermeier et al., n.d.)

6.5.1 Installation of Residential Chargers

An EV with a type 2 cable can be plugged into any 16A socket in which case the charging power is limited to 2.8kW. Private chargers in Germany are generally rated between 3.7kW and 22kW. These chargers are provided by different third-party vendors. The maximum power is not only

limited by the EVSE but it also depends on the vehicle type (*Hinweise Für Ladeeinrichtungen (Wallboxen) Für Elektrofahrzeuge in Einzelgaragen*, n.d.) . The following requirements are set for the users that are served by Stromnetz Berlin.

- Newer houses in Stromnetz Berlin’s territory generally have enough available contracted power capacity to be able to accommodate a 11kW EV (3 x 16A) charger.
- There is an obligation for all users to register their charging unit with their network operator.
- Each connection point must have its own Residual current device (RCD)
- EV chargers connected to the German low voltage grid has to comply with VDE-AR-N 4100 standard.
- The expected costs of installation are given in the table below

Table 6.1: Typical EV charger installation cost in area served by Stromnetz Berlin

11kW EVSE (without circuit breaker)	INR 61,576 (EUR 700)
Circuit breaker	INR 43,983 (EUR 500)
Other components including cables and other accessories	INR 17,593 (EUR 200)
Assembly cost	INR 70,373 (EUR 800)
Total cost	INR 1,93,527 (EUR 2200)

6.5.2 Regulations for integration EV charging facilities

The EV charging facilities must comply with different regulations dependent on whether the charging stations has been integrated to the low voltage grid (up to 0.4 kV), medium voltage grid (10 kV – 20 kV) or high voltage grid (110 kV or higher) (INTERPLAN, 2018).

For connection to the LV grid

The charging station has to comply with VDE-AR-N 4100 with VDE-AR-N 4105 in order to connect to the LV grid. During charging, fixed power factor ranges are to be kept depending on the current active power. For chargers with nominal power > 4.6 kVA, the grid operator may also define a method for reactive power control. For charging stations with nominal power > 12 kVA, the grid operator may deny connection unless they are equipped with a controller which allows for shut-down of the charging station by the grid operator in case of emergency. In addition for DC and inductive charging devices with nominal power >12 kVA grid operator can request reactive power control capability (a volt-var characteristic), a cos (P) characteristic or a power factor (cos phi) in the range between 0.90 inductive and 0.90 capacitive from these charging stations.. There are also requirements for the active power behavior during over and underfrequency

periods/events. During discharging, these charging stations need to comply with the rules of LVRT and HVRT.

For connection to the MV grid

For connection to the MV grid, the charging stations have to comply with VDE-AR-N 4110. As per this regulation there is no mention of LVRT and HVRT requirement yet. However, the reactive power requirement applies depending on the nominal power rating of the chargers. For chargers with nominal power > 12 kVA the charging station need to have reactive power control capability, same as distributed generators. But for chargers with lower power rating, the charging station just needs to maintain a minimum power factor level, without any need of different control modes.

For connection to the HV grid

VDE-AR-N 4100 regulates the requirements for integration of EV charger to the HV grid. The requirements of this regulation is similar to that of VDE-AR-N 4110.

6.5.3 Charging management System

The network operator Stromnetz Berlin has implemented a charging management system to control the EV charging loads. With this system, vehicle fleets, charging at public chargers are utilized to optimally share the collective EV load. This has resulted in reduction of grid upgradation requirement.

Passive Charge Management

This is actually dumb charging, and the vehicles are charged at their maximum power capacities.

Static Charge Management

In this management system the available charge margin is shared between all the charging points.

Active Charge Management

The available power margin for charging is distributed proportionally to the maximum power capacities of each EV. As shown in Figure 6.6, when more EVs start charging using the slow AC chargers, the power drawn by the first AC charger reduced from 11kW to 5kW (illustrative example).

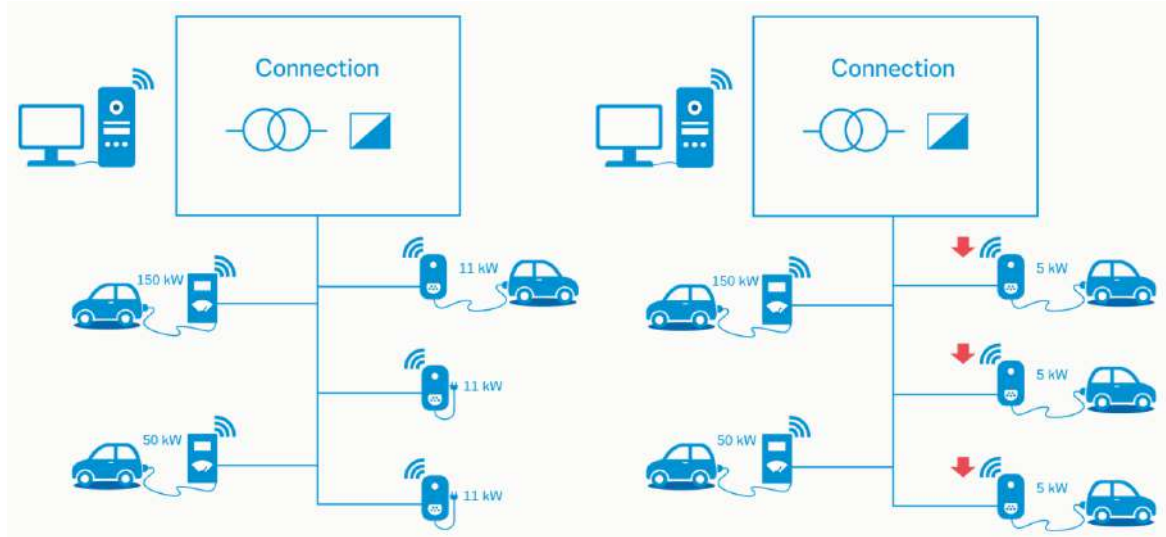

Figure 6.6: Active charge management (*Charging Management System, n.d.*)

Dynamic Charging Management

In dynamic charging management the overall performance of a grid parameter such as loading of distribution transformer, loading of transmission cables etc. is monitored and based on the current status of the observed parameter the charging power is allocated to each EV. Figure 6.7 shows an illustrative example of dynamic charge management. As seen, the power level of the charger at the end of the feeder is less than the power drawn by the charger at the start of the feeder. This is because chargers located at end of the feeder puts additional burden on the system due to the added line losses and also the deteriorated voltage profile.

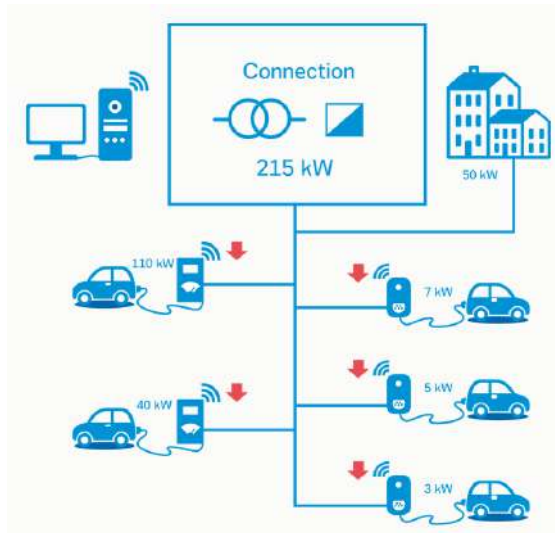

Figure 6.7: Dynamic charge management (*Charging Management System, n.d.*)

Scheduled Charge Management

Depending on the time of use, vehicles are charged at different power levels, however fast DC chargers are allowed to operate at maximum rated power irrespective of time of day. In this management system, charging of a vehicle at other charging points is not allowed.

6.5.4 Metering of EV charging

The metering of EV charging may be done either at the household mains in which case the EV charging load is considered to be a part of the household load, or a separate meter may be installed for the EV charging station for separate billing of the energy consumed due to EV charging. Having a separate meter for each charging point enables the user to make the charging station controllable and thus benefit from the reduced fees under Section 14A of the EnWG (Controllable consumption devices). The different types of metering arrangements are given in Figure 6.9.

There are two types of meters that are generally distributed in Stromnetz Berlin's operational territory, modern metering device and intelligent metering device (smart meters).

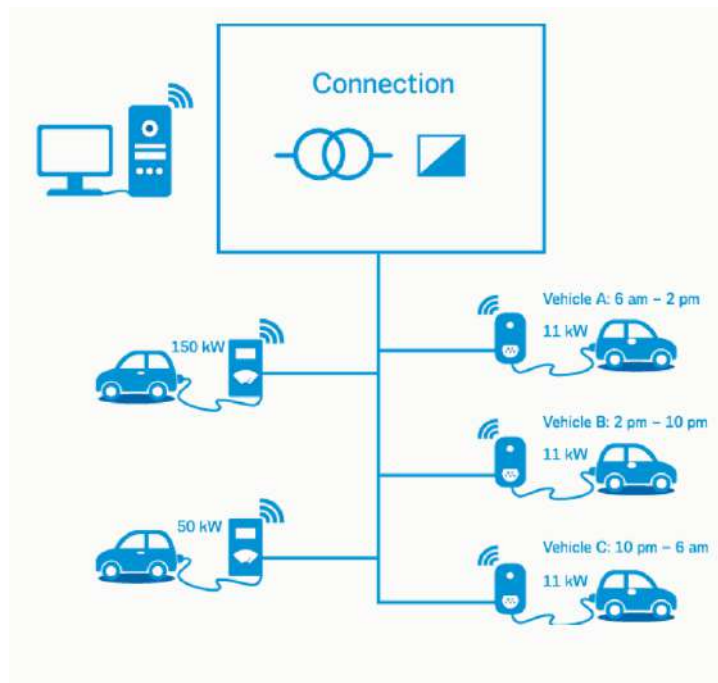

Figure 6.8: Scheduled charge management (*Charging Management System, n.d.*)

The **modern metering devices** are digital meters with data logging capacities of up to 24 months. There is no communication unit connected to the modern metering units so they cannot be read

remotely. So billing is done annually or monthly and the meter has to be read on-site. Since 2017, all the meters in Stromnetz Berlin have been gradually replaced by modern metering devices.

Intelligent meters (smart meters) are digital metering system that has a communication unit, so the consumption data can be monitored remotely. The units send the consumption details to the authorized market participants (meter operator, DSO and TSO, energy supplier).

The timetable for the introduction of metering system based on different consumption levels is given in Table 6.2

Table 6.2: Meters based on consumption levels and replacement timeline

Annual consumption (kWh/per annum)	Technology	Replacement timeline
Up to 6,000	Modern metering device	Within 16 years from Oct 2017
>6,000 to 10,000	Intelligent metering device	Within 8 years from 2020
>10,000 to 100,000	Intelligent metering device	Within 8 years from 2020
>100,000	Intelligent metering device	Within 16 years from launch

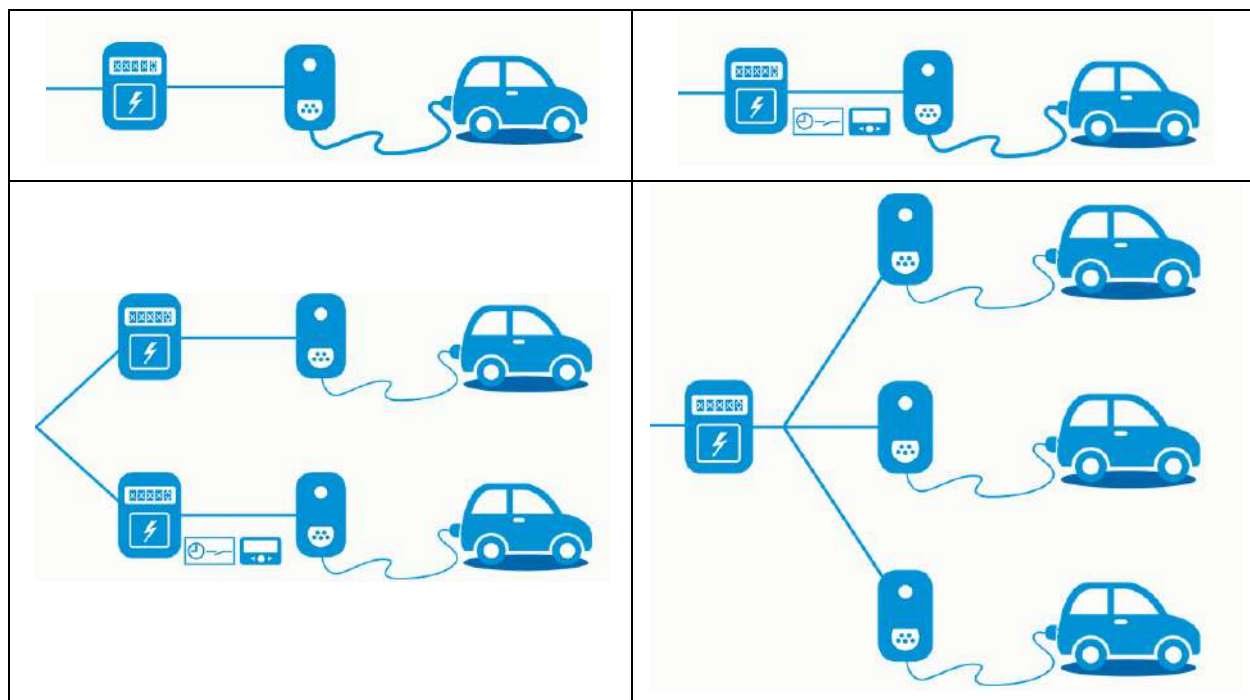

Figure 6.9: Different metering arrangements to meter EV charging loads, single measured charging point (top left), single measured controllable charging point (top right), several individually measured charging points (bottom left) and several charging points but one measurement unit (bottom right) (*Metering of the Charging Process*, n.d.)

6.5.5 Standards for EV integration

In order for effective mass market adoption of EV, Germany has released a roadmap of standards and specifications, which includes standards for EV charging interface (both wired and wireless) and information and communication technology.

Table 6.3: General Requirements

Requirements for the vehicle side charging interface	ISO 17409: Safety requirements for connection to an external electric power supply
Requirements for charging infrastructure and charging interface	IEC 61851-1: General requirements of electric vehicle conductive charging system
	IEC 62196-1: General requirements for connectors for EV charging
	IEC 60364-7-722: Installation of low voltage systems-requirements for the power supply of electric vehicles
Electromagnetic compatibility	IEC 61851-21-1: Electromagnetic compatibility requirements for on-board charging devices for electric vehicles in order to establish a conductive connection to an AC or DC power supply
	IEC 61851-21-2: Electromagnetic compatibility requirements for off-board charging systems for EV

Table 6.4: Standards for Charging Interface

Wired charging	IEC 61851-1, IEC 61851-23, IEC 62196-1, IEC 62196-2, IEC 62196-3, ISO 17409: Combined Charging System (CCS) for AC and DC charging
	IEC 625752: Mode 2 charging cable including IC-RCD safety device
Wireless charging	IEC 61980: Infrastructure requirements
	IEC 61980-2: Charge controller, positioning of vehicles
	ISO 15118-1, ISO 15118-2, ISO 15118-8, IEC-61980-2: Communication for wireless charging
	ISO 19363: Safety requirements and charge controller requirements for vehicle side charging interface
Communication	ISO 15118: Communication interface between vehicle and charging infrastructure and also for wireless charging

ISO 15118-3: Requirements for the physical layers and data link layers for wired communication

ISO 15118-8: requirements for the physical and data link layers for wireless communication

ISO 15118-2: Requirements for grid and application protocols for V2G.

Large-scale deployment of electric vehicles in Germany by 2030: An analysis of grid-to-vehicle and vehicle-to-grid concepts (Loisel et al., 2020)

Objectives of the study:

1. Analysis of the future German power system with Electric vehicles
2. BEV hourly load profile projection by the size of a car
3. Use of Power dispatch optimization model to assess strategies for optimal charge/discharge of V2G (vehicle-to-grid) and G2V (grid-to-vehicle) strategies.

Introduction:

To meet the renewable energy and carbon emission targets, the EU is shifting towards the electric transport sector. Still, it is facing significant challenges due to higher investment costs and the need for charging infrastructure. The future scenario is projected where aggregator implements EV smart charging strategies. Four types of electric vehicles are considered for the study, namely, 'mini', 'small', 'compact', and 'large' with a range limit of 160 km and battery capacity of 15 kWh, 20 kWh, 24 kWh, and 30 kWh, respectively.

The study estimates the BEV-induced load in the German grid by 2030 based on driving patterns, assesses the impact on the power system due to electric transport, and reports the power demand as well as power generation from renewable generation sources.

In this methodology, efficient use of resources is allowed by recharging the EVs during peak renewable energy generation hours and charging during off-peak hours.

Methodology:

Electricity demand of BEVs: A projection for Germany by 2030:

A projection of electricity demand in Germany by 2030 is created using driving and parking behaviour (considered to remain constant), which directly influences charging behaviours. The survey is conducted for 25,992 households and 60,713 individuals to complete a 1-day trip diary with files, namely 'Cars', 'Trips', and 'Households', with all the relevant data for the study. One minute to hourly aggregated driving and parking patterns are created for power plant dispatch model formulation.

Electricity demand for EV charging is input to the power plant dispatching model. The projections are described based on 'Highly decarbonized' and 'Slightly decarbonized' scenarios with high and low oil &

natural gas prices. The estimated number of EVs with these scenarios is 4.8 million and 1.1 million respectively by 2030. The proportion of cars by 2030 is determined based on the current proportion of the car segments. The cost-benefit analysis is performed with techno-economic parameters such as round-trip efficiency, the Li-ion battery life cycle, battery cost, etc.

The driving and parking behaviour is analysed for weekdays and weekends, which shows that most EVs are driven between 7:00 am to 5:00 pm with morning and evening peaks at 7:00 am – 8:00 am and 5:00 pm–7:00 pm, respectively, shown in Figure 6.10. Trips start later on the weekends than on the weekdays and consume more electricity.

Apart from the peak periods, the usage ratio shows that more than 70 % of EVs are idle from 7:00 am to 7:00 pm, and more than 90 % remain idle from 8:00 pm to 6:00 am on both weekdays and weekends and hence can participate in charging/discharging strategies of the G2V and V2G schemes.

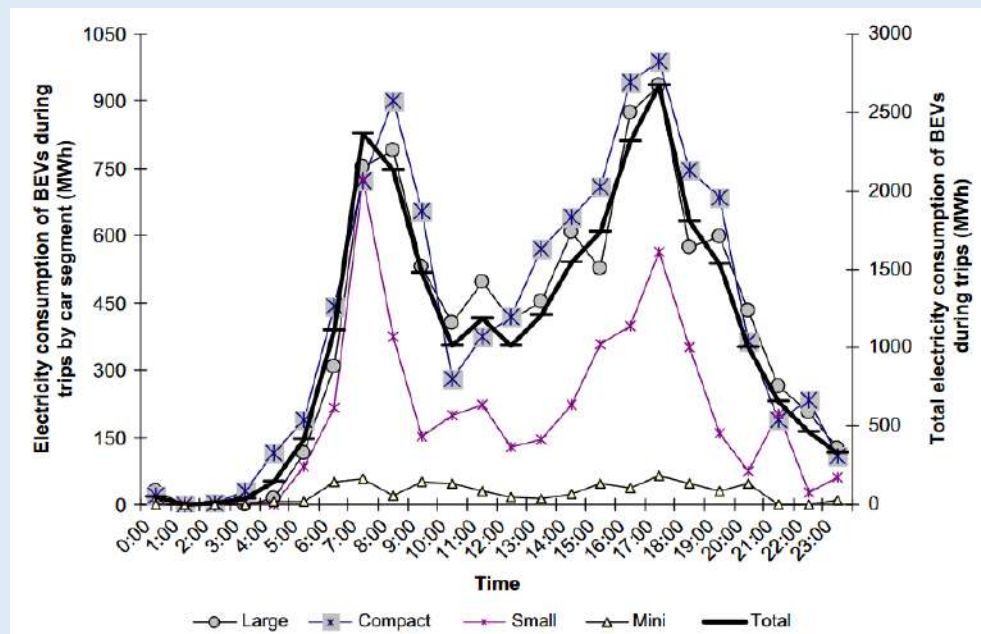

Figure 6.10: Electricity consumption of BEVs on a typical weekday (Loisel et al., 2020)

Power plant dispatching model:

The model is based on linear programming and designed for describing power generators. The dispatch objective is to minimize the cost of annual variable generation by operating interconnection capacities and power generators. Generation capacity is fixed during the simulation year. Considering the technical and economic constraints, the total power system operational cost is minimized with the model, with technical constraints being the max load factor, ramping rates, min operational costs, and min operational levels.

It is assumed that the aggregator (central fleet operator) manages the charging of the grid-integrated EVs. The program has demand-side and supply-side constraints to fulfil load demand and ramping limits, respectively.

Several EV deployment scenarios are considered in the study with assumptions such as the increase in the renewable energy share, phasing out of the nuclear power plants. The slow development of EVs is a 'Slow' scenario with an EV population of 1.1 million by 2030. A rapid EV population increase is an 'Acc' (Accelerated) scenario with an EV population of 4.8 million. The scenarios consider half of the EVs charging/discharging with a 3.7 kW slow charger and another half with a 60-kW fast charger.

Two structures are tested with 100 % EVs charged from home or slow charging called 'HOME' and 100 % EVs charged from fast charging called 'FAST'.

Analysis of results:

Grid-to-vehicle scenarios:

With no electric vehicles, the imports increase by 50 %, and the shadow cost rises by 38 % due to increased generation from conventional power plants such as coal and natural gas. Renewable energy generation amounts to 50 % of total demand in 2030, with wind curtailment amounting to 2.9 GWh and a 2 % curtailment rate for solar power.

With grid-to-vehicle scenarios, additional demand of 0.45 % and 2 % is created by the Slow scenario and Accelerated scenario. It not only adds the power demand but also can absorb excess solar and wind power. In the Slow scenario, the solar power curtailment is reduced by 18 %, which amounts to 384 GWh/year, but, on the other hand, it increases the CO₂ emissions by 0.9 Mt of CO₂. The accelerated scenario reduces the solar power curtailment by 847 GWh, increases the CO₂ emission to 4.5 Mt of CO₂, and increases the system costs.

Storage provision through the vehicle-to-grid scheme:

Due to higher flexibility, energy provision in the Slow scenario is higher than the accelerated scenario. The battery charging/discharging is a function of marginal power cost, and hence the charging occurs during high renewable energy generation hours and the night. The discharging occurs during morning and evening peak demand hours to maintain a supply-demand balance.

The EV population's power capacity is 26.4 GW and 114.8 GW in the Slow scenario and Accelerated scenarios, respectively. The reserves provided by the Slow scenario and Accelerated scenario are 323 GWh and 21 GWh, respectively. With load factors, batteries can support less flexible technologies with the ramping operations along with renewable integration. 923 GWh reserves are provided with a new optimized system that decreases CO₂ emissions, system costs, and generation costs.

A cost-benefit analysis of the V2G scheme:

For accessing EV battery degradation, battery power and battery capacity are considered with the assumption of the complete charge-discharge cycle which occurs at 80 % discharge depth which is correlated with the number of cycles. The depreciation cost ranges from INR 59.82 (EUR 0.679)/cycle to INR 138.99 (EUR 1.577)/cycle for 15 kWh (Accelerated scenario) capacity and 30 kWh (Slow scenario) capacity, respectively.

Sensitivity tests:

With a set of tests, the assumption's sensitivity on the number of Electric Vehicles participating in the V2G scheme is identified. Charging 100 % EVs from fast charging does not make a significant difference as compared to Slow charging. V2G slow charging from home decreases the power delivered from 323 GWh to 152 GWh and reduces curtailment capacity by 140 GWh. The G2V accelerated home charging has a negative impact on solar power curtailment (-55 GWh).

Conclusion:

The positive impacts of controlled EV battery charging in G2V are evident with reserves and reduced solar power curtailment. The base-load and mid-load are supported by the V2G scheme by reducing the ramping operations and increasing the capacity factors. V2G helps in higher integration of variable renewable energy generation than G2V with reduced system costs. These capabilities of EVs are limited by battery degradation and economic support.

Mobile electric batteries compete with other flexibility options that could theoretically offer similar flexibility services at a lower cost in the V2G case, in which BEVs are essentially used as a storage commodity within the power sector. Synchronization between all parties is needed for BEVs to become a viable choice in the power system. None of the stakeholders is likely to build a viable BEV business case on their own.

Effects of electric vehicle charging strategies on the German power system – a research study
(Hanemann et al., 2017)

If the electricity needed for charging comes from low-carbon sources, electric vehicles (EVs) can help reduce greenhouse gas (GHG) emissions in the transportation sector. In addition, depending on the charging method, EVs have a considerable influence on the nearby power network. The degree of intelligent system integration may be used to characterize these charging schemes. Users can charge as soon as they are connected to the grid using uncontrolled charging (UNC). Cost-driven charging is a type of demand-side management in which the charge must be finished at a specific time. As a result, controlled charging, in which the activity is regulated, is frequently used. As a result, there are regulated charging, in which the activity is frequently controlled by price spreads within the resultant time span. This research looked at the effects of the three EV charging techniques on the German power grid. The study is significant since it

supports the “Energiewende,” a major structural shift toward renewable energy that entails a complete overhaul of the large-scale power infrastructure.

EVs can also provide demand and storage flexibility, which is a characteristic that has yet to be explored in Germany. As a result, other power systems, primarily defined by fossil fuel-powered production and intending to expand their RES considerably, may find this instance of interest. The study adds to the existing literature by using sophisticated and unfolded EV data to represent distinct units of EV clusters, a consistent grouping of weekdays and weekends with daily varying power system demand, and the provision of an option to deal with the relative independence of these day types in traffic studies. The research also takes into account the interdependencies with other studies. The study also considers interdependencies with other power systems and extends on the German instance; however, because these effects are nonlinear, various system states may provide different conclusions. It is demonstrated that the impact of electric vehicles on various power plant types varies qualitatively depending on greenhouse gas costs. As a result of the various merit order curves generated by a detailed collection of diverse greenhouse gas costs, the influence of EVs is generalized.

This research uses EVs in the MICOES spot-market unit commitment model (Mixed Integer Cost Optimization Energy System). The different generating facilities are represented in the model by their distinct techno-economic features. The model’s goal is to reduce the system’s overall running costs as much as possible. The power plant production is semi-continuous, and binary variables are utilized to describe the start-up procedures and time steps of each unit. The model’s goal is determined by the system (electricity and heat balance) and the unit restrictions (ramp rates, minimum load or shut down times). The electricity generated by RES is based on synthetically generated time series for all nations based on meteorological conditions from a reference year. Curtailment of renewable energy sources is judged reasonable when the entire energy balance is taken into account, and it is priced in line with current market circumstances. Net electricity transfer between countries is constrained by net transfer capacity (NTCs). The central focus has been on EV modelling and parameterization. The three charging techniques of UNC, DSM, and V2G are used to implement EVs. Due to its inherent deterministic nature, UNC’s scenario is represented by adding the EVs’ demand to the system’s electric energy demand. DSM and V2G, on the other hand, are considered as miniature mobile energy storage units, allowing for additional degrees of freedom in the power system.

The switching choices between charging and discharging and the status of the grid connection are represented by a specific mixed-integer programming formulation. For minimizing energy transfer between cars with varied driving patterns, EV clusters with separate arrival and departure timings are utilized instead of using the available fleet composition. The rolling horizon technique was utilized to decrease computing complexity instead of optimizing the entire year at once. A decrease in the number of sub-problems was

more appropriate since it better compensates for uncertainty over more extended periods. One optimization is performed across an optimization horizon (OH) in each iteration, including a separate 'T' hour. The control horizon (CH), which acts as a "memory," then maintains track of the system's status. The selected optimization horizon is longer than one day, allowing mobile storage plants to optimize their charging overnight in anticipation of reduced spot market pricing. The time-dependent parameter set comprising maximal capacity, minimal capacity, maximum charging power, and energy parameter (state-of-charge (SOC) difference) characterizes each energy storage facility. When the cluster of vehicles is disconnected from the grid, the SOC is set to zero by reducing capacity, relating to the trip duration. The discrete energy balance describes the dynamics of various storage facilities, primarily EV batteries, including charging and discharging efficiency, as well as charged input and discharged output.

The scenario evaluations for 2030 were conducted following the German government's official energy policy objectives, taking into account a wide variety of CO₂ pricing. After that, the optimization model is run for a whole year, totaling 8760 hours. The optimization horizon was set at 36-hours as a trade-off between computing complexity and forecasting interval, which was required because a shorter horizon would ignore the potential of trading energy throughout the parking period, whether night or day. The control horizon for this experiment was set at 24 hours. The national power consumption in 2030 is expected to reach 535 TWh, according to the German Grid Development Plan (NEP5) of 2013. RES is expected to provide about two-thirds of the energy consumed, based on total installed generating capacity. Synthetically produced time series are utilized for offshore wind. The anticipated thermal production capacity is 69 GW, which matches the Federal Network Agency's list of power plants that are under construction, planned, or decommissioned. Gas power plants are labelled as 'added' because they compensate for the lack of power supply to satisfy demands. As a result, gas turbines have the most significant market share in Germany. In terms of generating adequacy, they might be considered a backup option. They have lower efficiency and cheaper investment cost than combined cycle and gas turbine plants (CCGT). Due to the continuing phase-out, Germany's operational nuclear power capacity is zero. The phase-out is expected to be completed by 2023. The Netherlands, Belgium, Hungary, France, Switzerland, Austria, the Czech Republic, Poland, and Denmark's western and eastern parts are listed as neighbors. All of the data is stored in the UC modelling framework in a simplified manner that overlooks the need for minimal power plant downtime. The capacity of exported and imported power is 25 GW and 27 GW, respectively. Based on the decreased minimum power needs and projected ramp rates, it is also estimated that power plants provide enough flexibility owing to the more significant feeding of intermittent RES.

In 2030, six million electric vehicles were parametrized. The load curves for unregulated charging are then developed for weekdays (WD) and weekend days (WE). These load curves are deterministically applied to

the energy demand in the UNC scenario. Because each vehicle was modelled separately, the scenarios DSM and V2G may yield a tuple consisting of four parameters for each mobile battery, namely “maximal capacity,” “energy consumed” by travelling (as measured by DSOC), “hour of arrival,” and “hour of departure”. When the mobile batteries are classified according to the hourly combinations of departure and arrival, there are a total of $24 \times 24 = 576$ daily EV clusters. The overall ‘maximal capacity’, the total ‘energy consumed’, and the exact number of cars that belong to it all define each cluster. It would be computationally costly to resolve each of the 576 mobile plants individually. Due to the unequal nature of these dispersed plants, a lower number of 16 plus one additional aggregated cluster was decided. Each storage cluster comprises one hour forward and one hour backward of the original arrival and departure times, at the most. The extra cluster is present since only a tiny percentage of cars drives every day. The remaining cars are permanently connected to the grid and serve as fixed storage units, which increases even more during weekends. After completing their last journey of the day, EVs are anticipated to fully recharge their batteries for the next day, according to the optimization horizon. The charging power per EV was estimated to be 11 kW three-phase, with charging and discharging efficiency set at 90%.

WDs and WEs are considered to be when individuals utilize their automobiles. Nonetheless, these driving tendencies for WDs and WEs in the sample are unrelated to one another. Additionally, for WDs and WEs, two mobile batteries and one permanent battery are illustrated. Due to typical work schedules, it is expected that WD reflects the primary driving pattern. On Mondays and Fridays, the WD driving pattern is in effect. However, there is a bidirectional changeover to WE. The characteristics of mobile storage plants are allocated according to their overall capacity share at arrival and departure time to enable a transition from WD- to WE-cars and vice versa. The EVs are represented by two automobiles and one stationary storage for each day type.

For determining the interdependencies within the European power system, the cost and emissions data were extended to neighboring nations. The study’s results highlight the following crucial considerations for policymakers. For starters, EVs can exacerbate or alleviate power shortages, affecting pricing and total system costs. During peak demand, UNC is mainly applied after the previous trip, resulting in higher pricing. Flexible charging solutions either shift demand to low-cost hours (DSM) or reduce peak demand by sending power back to the grid (V2G) while decreasing costs. As a result, it would be advantageous if the rapid adoption of electric vehicles were matched by a rapid move to improved charging alternatives. On the other hand, EVs aid in the integration of RES, and all charging alternatives aid in reducing their curtailment. In terms of RES integration, V2G is by far the most feasible solution, once again driving a shift to more sophisticated charging choices. Third, the power flexibility afforded by EVs, when combined with high CO₂ pricing, results in fewer CO₂ emissions. Because flexibility favors the lowest-cost manufacturing facilities,

emission-intensive technologies like lignite power plants may be promoted. However, once the CO₂ price is high enough to sustain low-emission technology, the flexibility of electric vehicles improves the competitiveness of low-emission power plants. The emission-intensive output of lignite power plants is further reduced as a result of this event. Furthermore, it is critical to recognize that these effects are nonlinear, resulting in disparities in absolute terms when findings are compared at high and low CO₂ pricing. As a result, a well-functioning carbon trading mechanism with sufficient price incentives is required to realize EVs' promise fully. Fourth, the integration of sophisticated EV charging techniques produces favorable systemic synergies in terms of CO₂ emissions and energy production costs. As a result, increased output through emission-intensive technologies resulting from flexible EV charging schemes does not always imply increased CO₂ emissions. Better integration of renewable energy sources, more significant energy exchanges with neighboring nations, and replacing traditional thermal power plants all contribute to a responsible counter impact. When the value of an EV's flexibility exceeds its energy need, the total cost of energy generation falls. From a systemic standpoint, it emphasizes the necessity of storage technology. Finally, EVs can compete with other flexible alternatives, like pumped-storage hydroelectricity facilities that provide power to Germany in the near term. Because flexibility is an essential quality for integrating intermittent renewable energy sources, appropriate incentives must be addressed to maintain them in the system.

Ubitricity (Charging point operator)

Ubitricity specializes in providing lean charging station solutions, which can be easily integrated into congested or constrained spaces. One of the standout solutions is the retrofitting lamp posts as EV charging stations. Their novel smart charging cable has an integrated smart meter than enables the user to charge at any charging point and the energy is billed via the smart cable. (Ubitricity, 2019).

Countries of operation: Germany and the UK

Consumer type: The company provides both private Business to business (B2B) and business to consumer (B2C) as well as public B2B and B2C charging solutions.

Services provided: The customer is provided with a smart cable which consists of a meter for measuring usage and the two ends to connect to the EV and a charging point. The company aims at providing hardware that is lean and space saving. There are two charging speeds offered. The company also provides its own user mobile app.

Partnership: Ubitricity has partnered with power retailers for providing electricity, other EV charging providers for E-roaming via Plug Surfing and the local authorities in setting up charging sockets.

Pricing: Consumers pay through subscription and the price depends upon the contract of the users with their energy provider. The smart cable combined with the simple sockets offers three variations (Simple Socket-start, Simple Socket, Simple Socket-Plus) for metering and billing requirements of the consumer.

Key Highlights: Ubitricity pioneered the retrofitting of existing lamp posts with in-column charge points. The EV charging points are technically lean and can be operated with minimal running costs. A key advantage of the Ubitricity solution is the reduced installation time due to the lack of a requirement for earthworks. In addition, the user is allowed to choose their preferred energy provider and has access to smart billing over a wider charging network.

6.6 Case Studies

6.6.1 Study on Distribution grid planning for a successful energy transition – focus on electromobility

Project category: Research Study

Publication date: October 2019

Project Aim:

The study investigates the extent to which of smart charging strategies of EVs reduces peak loads on the networks in order to delay the need for network expansion.

Project Overview:

The study was conducted by Navigant, Kompetenzzentrum Elektromobilität and RE-xpertise on behalf of Agora Verkehrswende, Agora Energiewende and RAP. Figure 6.11 illustrates that smart charging can reduce investment in distribution networks by up to 50 percent by 2030.

Two scenarios are considered in the study, the first, with 15 million electric cars by 2030, would require 36 billion euros in distribution network investments, while the less ambitious scenario, with 6 million cars, would require 1.4 billion euros in annual distribution network investments (Navigant et al., 2019).

Project Results:

The project concluded that grid friendly charging minimizes increased peak demand from simultaneous charging of EVs and electric heat pumps. Secondly, the results indicated that combining smart charging strategies with the e-mobility transition can fund the energy transition, providing annual investment of 1.5 billion euros in transmission and distribution infrastructure. The study further concluded while EVs will increase electricity consumption, the overall investment required for grid reinforcement will not increase.

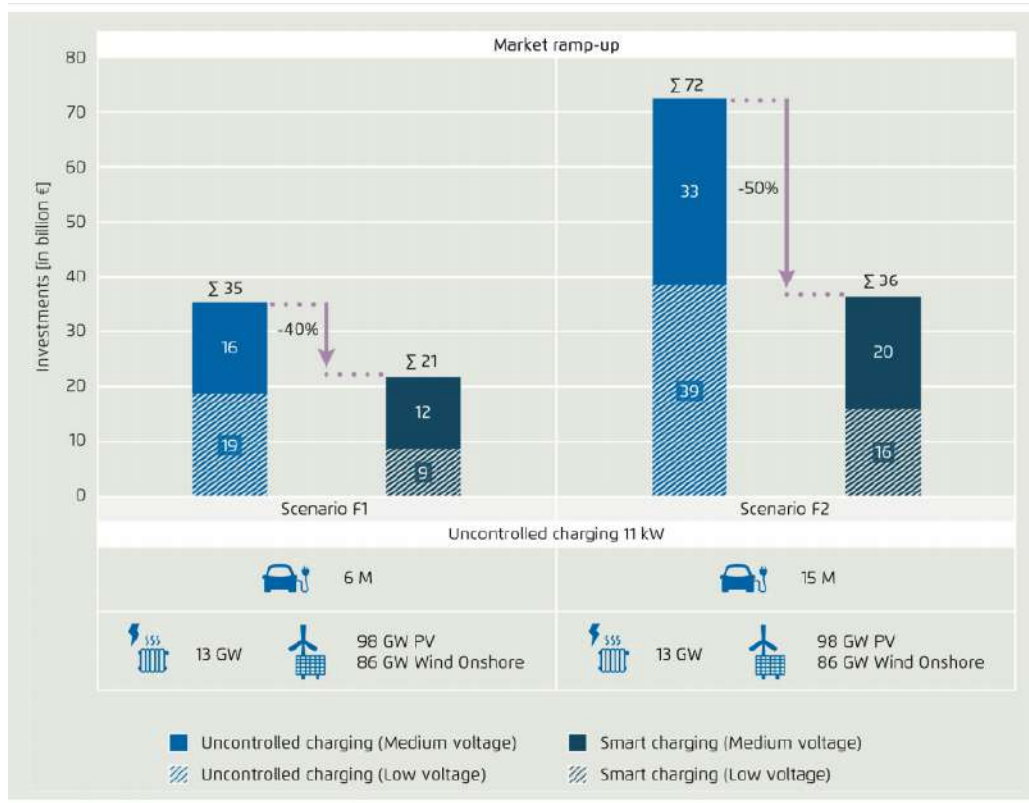

Figure 6.11: Reduction of cumulative distribution network investment through smart charging, Source:(Navigant, Elektromobilität Kompetenzzentrum, and RE-xpertise 2019)

Lastly the study recommends precautionary indirect control such as incentives for grid friendly charging(Navigant et al., 2019). The study concludes that a fully electrified transport fleet in Germany would not impede the energy transition in the distribution networks.

Key Learnings:

The project sheds light on the two major challenges of the energy transition with regard to power distribution. First, the growing share of intermittent renewable energy generation, mainly wind and solar. The second challenge is the potential to increase peak demand from heat pumps and the electrification of transport. This presents through the lens of conventional grid planning, these three drivers - feed-in from renewable energy sources, and the additional demand from heat pumps and from electric vehicles – would indicate that the electricity distribution grid needs to be expanded. However, so-called “smart charging” of electric vehicles can help to reduce peak loads on the networks and, in turn, delay or obviate the need for network expansion. Therefore, charging

processes should be shifted to times that benefit the grid, i.e., ensuring higher utilization of network capacity.

6.6.23 connect

Project Category: Demonstration Project

Project aim: The aim of 3connect is to work with research and development partners to make electromobility fit for the future throughout Germany. So far, power generation and its utilization in the form of EVs were techno-economically decoupled. Hence to boost the electromobility market and allow renewable energy integration, the connection establishment is necessary to propel the smooth functioning of the economy. Networking protocols can play a bridge role in this case (*3connect*, 2021).

Project Duration: 2016-2019

Stakeholders:

Smartlab Innovationsgesellschaft mbH (Leader of the consortium), ABB AG, ABT Sportsline GmbH, Allgäuer Überlandwerke GmbH, cantaman GmbH, HaCon Ingenieurgesellschaft mbH, Hochschule für angewandte Wissenschaften Kempten, Innovationszentrum für Mobilität und gesellschaftlichen Wandel (InoZ) GmbH, John Deere GmbH & Co. KG, KEO GmbH, MENNEKES Elektrotechnik GmbH & Co. KG, Next Generation Mobility GmbH & Co. KG, regio IT gesellschaft für informationstechnologie mbH, RWTH Aachen, Schleupen AG, Stadtwerke Aachen AG, Stadtwerke Osnabrück AG, StreetScooter GmbH

Project Summary:

The approach

At three areas (hubs), 18 accomplices are creating ICT based applications. Every one of the arising segments and frameworks highlight a few interfaces to permit an attachment and play mix of both equipment and programming. The Osnabrück accomplices are making an application-based e-portability stage. It unites continuous information from electric vehicle and pedelec¹⁴

¹⁴ A pedelec (pedal electric bicycle) is a electric bicycle in which a small motor is attached to assists the rider's pedaling.

sharing, electric cabs, charging focuses, public vehicle and the network, and furnishes clients with a coordinated versatility offering. The Aachen group is planning astute lattices and energy markets for business coordination. In the Allgäu locale, project accomplices are executing answers for horticulture just as for civil and business organization.

Technical description

The requirement is to optimize technical and commercial forecasts (variable tariff), demand and supply together to exploit flexibility in service or business. Requirement comes from partners through energy management system. The optimizing algorithm in the Energy Management System (EMS) calculates forecasts for renewable power generation and demand availability. Considering variabilities of load and switching, above mentioned optimization is carried out. These optimized schedules are exchanged with the market platform provided by the project partner Schleupen AG for day ahead trading. Then EMS fulfills the traded energy portions in the following hours.

The decentral EMS itself runs on ABBs Ability programming stage, utilizing the most recent data innovations. The venture shows a few benefits, which are reachable when joining the energy with the portability area, utilizing an online enhancement.

ABB Ability OPTIMAX PowerFit

PowerFit exploits the software container technology Docker for flexible deployment on premise or in the ABB Ability cloud, depending on specific needs for data communication, cyber security requirements and integration with other cloud applications. ABB Ability is based on the Microsoft Azure Cloud, giving access to standardized applications, such as database storage and data mining / visualization in PowerBI. Highest cyber security standards are met with secure communication channels, system wide user authentication and atomic updates of a minimal immutable operating system running prepackaged software containers.

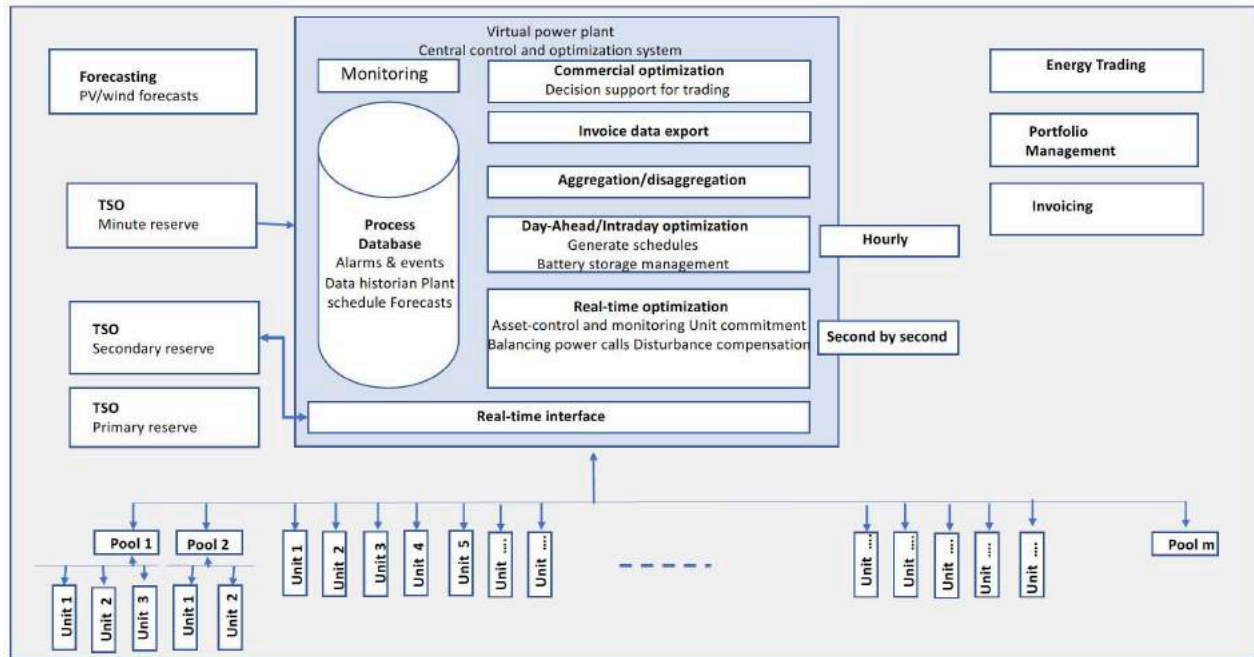

Figure 6.12: VPP concept in OPTIMAX Powerfit (OPTIMAX PowerFit, 2017)

The architecture shown above describes information exchange between various stake holders and smart charging control. Various inputs and outputs like energy forecasting, TSO events and constraints, DSOs capability and constraints, fleet charging opportunity as well as commercial invoicing, energy trading data and portfolio management are interacting with smart charger optimization. The Virtual Power Plant central control and optimization system consists of following sub blocks:

- | | |
|---------------------------|-------------------------------|
| 1. Process Database | 2. Real time interface |
| 3. Monitoring | 4. Commercial optimization |
| 5. Invoicing | 6. Aggregation/disaggregation |
| 7. Day ahead optimization | 8. Realtime optimization |

It is feasible to practice adaptability in changing streamlining objectives from one second to another due to the numerical model to advance force setpoints to the individual units continuously. The framework restrictions, interruptions and deviations from plans are consolidated into framework.

Key takeaways

- Profitable grid services and direct trading
- Optimal unit commitment and asset steering in one step
- Automated communication across all levels
- Scalable system architecture, from a few up to many thousands of units

Learnings

Any level of technoeconomic complexity regarding to EV fleet charging incorporation can be handled intelligently using time to time optimization. The objective of optimization depends on the use or purpose of the charging station it is set up for. Commercial aspects, Grid support aspects or combination of two with proper weightage to both of them. Customers must be willing to participate in such free and open market to support RE integration. The optimization again depends on customer behavior which is missing and could be only handled through policy instruments as it can assist the optimization objective functions in long run.

If scalability is considered, these platforms allow huge scalability options for time to come and allow various experiments and stake holders to conduct pilot optimization studies to make system more efficient. Data security issues will be a challenging part to be delt in more sovereign manner in future.

Chapter 7. Denmark

7.1 Background for policy making environment

Denmark is one of the most active countries in EV ecosystem. The Danish national government provides subsidies for chargers while local and regional authorities provide investments in equipment and provision of energy. Electricity generators and charge point operators ensure the operation and services for both public and private (fast) chargers. Other major stakeholders include the Danish Energy Agency and Copenhagen Electric.

The Alternative Fuels Infrastructure Directive sets requirements for the roll-out of infrastructure for recharging electric vehicles in urban and suburban areas and refueling natural gas vehicles in urban and suburban areas and on the TEN-T core network. As shown in Figure 7.1, Denmark surpassed the 2020 National Policy Framework targets for EV charging points.

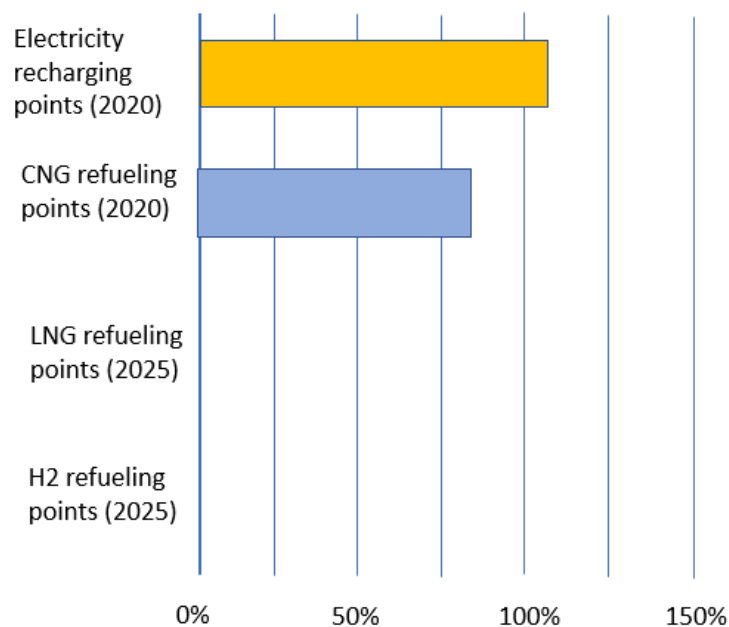

Figure 7.1: Current attained percentage of the NPF targets

7.2 EV Charging infrastructure policies and regulations

Table 7.1 applies the policy framework presented in The development of EV charging policies considers two fundamental perspectives: the supply (developers of EV charging infrastructure and charging service providers) and the demand side (EV users). This report applies the analytical

policy framework developed by the Florence School of Regulation (Bhagwat et al., 2019). The various elements to be considered within these perspectives are shown in the table given below.

Table 1.1 to give an overview of EV charging infrastructure policy in Denmark.

The Danish government has been keen on transforming on its mobility space by encouraging all types of clean fuel vehicles. Particularly for EVs, on the supply side, the government offers incentives and rebates on establishing EV charging points. There is a push for both public and private charging stations, including forming public-private partnership were needed to establish the infrastructure. Governed by the EU level policies, all densely populated areas need to have minimum EV charge points. Public charge points have incentives such as discounted power supply fees, reducing the overall costs, with a focus on establishing charge points in and around public buildings. Commercial vehicle charging, especially for buses, is underway. For consumers charging at home, there is a special rebate that reduces the overall charging bill by almost half. On the demand side, the technical standard applicable for setting up the charge points is Type 2. In terms of open protocols, the EV user must be given the option to access the charge points via various memberships offering interoperability amongst the three service providers.

Table 7.1: EV Charging infrastructure policy in Denmark

Policies Enabling EV charging on supply-side		
Element	Policy Instrument	Measures
Definition of a fundamental market design framework to limit distortions and entry barriers	Directive on the Deployment Alternative Fuels Infrastructure	<ul style="list-style-type: none"> • Direct public investment • Public-private partnerships • EU Member States to establish a charging infrastructure with adequate coverage in densely populated areas. Average number of recharging points should be equivalent to at least one recharging point per 10 cars. • Charging infrastructure deployment targets
The incentive for launching the EV charging market	Infrastructure incentives	<ul style="list-style-type: none"> • EUR 10 million for development of charging infrastructure • Since 2016, Denmark offers a tax exemption for commercial charging, which in 2017 was extended to 2019, and favorable tariffs for electric buses were extended to 2024 (Government of Denmark, 2017). • Publicly accessible charging points pay 50% less for their power connection fees. • The Capital Region of Denmark has established charging stations at all the region's hospitals and other central administration at Regionsgården in Hillerød, north of Copenhagen. • Charging facilities for electric vehicles will be included from the start when building new parking facilities. • A tax reduction of around INR 11.84/KWh (EUR 0.13/kWh) applies to companies that provide EV charging on a commercial basis.
Prioritization in terms of EV characteristics and social geography		<ul style="list-style-type: none"> • Consumers that charge at home receive a tax rebate of INR 11.13/kWh (EUR 0.13/kWh), cutting electricity costs almost in half (valid until 2020) (Government of Denmark, 2017).
Policies Enabling EV charging on demand-side		
Element	Policy Instrument	Measures

<p>Technical standardization of chargers for interoperability</p>	<p>Directive on the Deployment of Alternative Fuels Infrastructure</p>	<p>Charging points are required to have a "Type 2" plug for AC charging, and a "Combo 2" for DC charging (EC/94, 2014)</p>
<p>Harmonization of cross-border/cross-provider user registration for accessing charging infrastructure</p>		<p>Most EVSE outlets are not using open protocols, so EV car owners need a variety of membership cards to access the outlets of the three main charging point operators.</p>

7.3 EV Charging infrastructure

Figure 7.2 shows the growth and share of fast and slow chargers in Denmark. The number of chargers in Denmark is still limited, but the share of slow chargers (<22 kW) is much higher than that of fast chargers (>22 kW) in public charging stations.

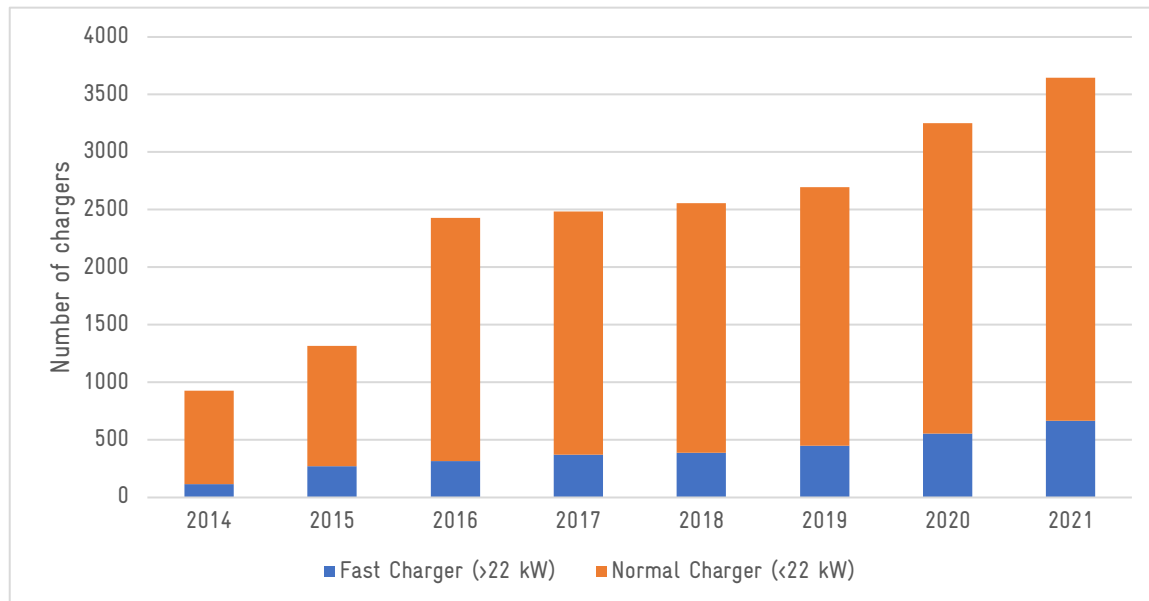

Figure 7.2: Number of publicly accessible chargers in Denmark (EAF0, 2021)

Several initiatives to roll out EV charging infrastructure in the country have been initiated. The European Long-distance Electric Clean Transport Road Infrastructure Corridor (ELECTRIC) aims to create an open-access fast charging corridor along the major highways connecting Sweden, Denmark, Germany, and The Netherlands. The project includes a study on interoperability, the framework for a sustainable infrastructure set up and will install a total of 103 chargers along the main motorways, 23 of which will be in Denmark (ABB, n.d.).

The Nationwide Fast Charge will transform 40, out of the 46 existing charging stations in Denmark into fast, multi-standard and interoperable facilities to meet the coming European standards and achieve compatibility with other EU countries. As a pilot deployment, the project is expected to not only help develop the electric vehicle infrastructure in Denmark, but also for the rest of Europe and foster drivers' acceptance of electric vehicles.

7.4 EV demand status

Denmark differs from the general trend in the Nordic region with fewer sales of new EVs in 2017 and a significant decline since 2015 (Cazzola et al., 2018). The country targets 1 million electrified

vehicles passenger light-duty vehicles (PLDV) stock by 2030 and no sales of new internal combustion engine cars by 2030.

Towards the end of 2020, the sale of electric vehicles rapidly increased for the BEV and the PHEV sector as shown in Figure 7.3. Although during April and May the sales of EV saw decline in 2020 as compared to 2019, this can be attributed to COVID-19, with sales picking up in July. It can also be seen that the growth of PHEV is much higher compared to BEV for the month of July and August, while BEVs were sold more in March, September and December with Ford Kuga being the most popular PHEV and Tesla Model 3 being the most popular BEV in 2020 as shown in Figure 7.5.

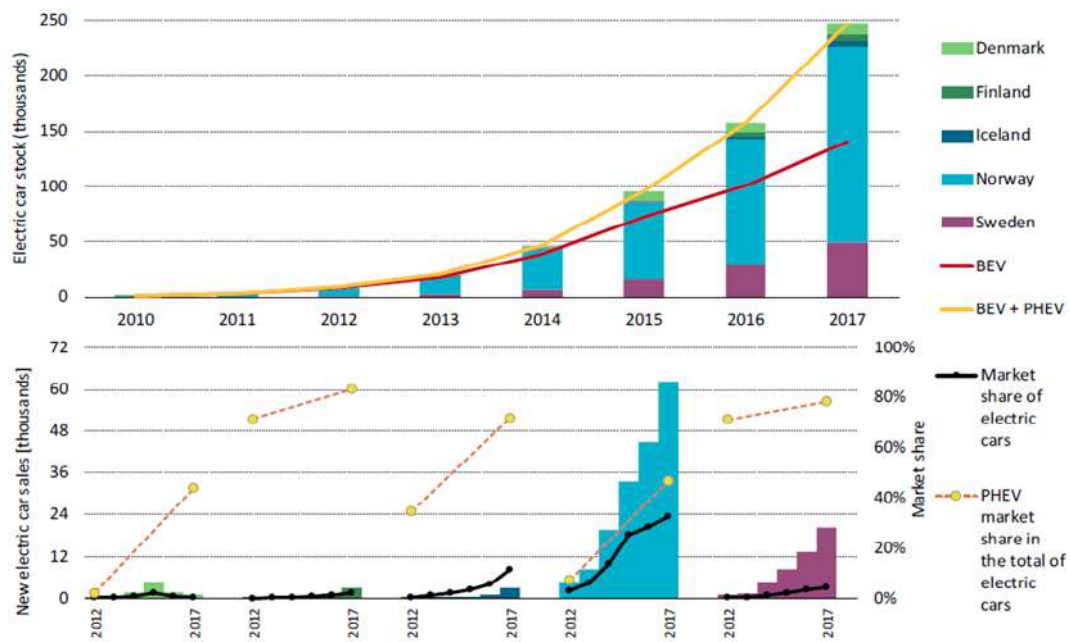

Figure 7.3: Number of electric cars, new sales and market share in Nordic countries, 2010-17 (Cazzola et al., 2018)

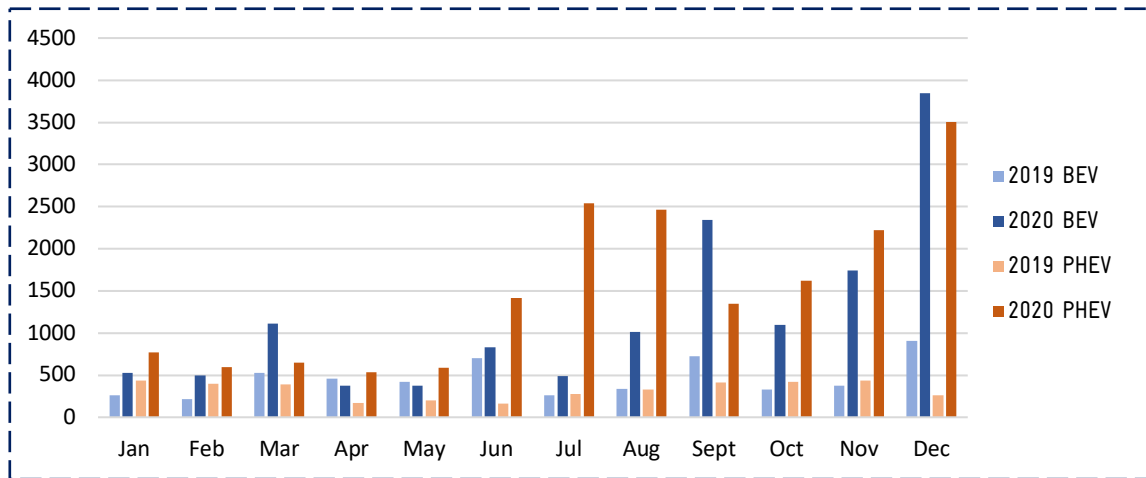

Figure 7.4: Comparison of monthly EV sales for 2019 and 2020 in Denmark (DBI, 2021)

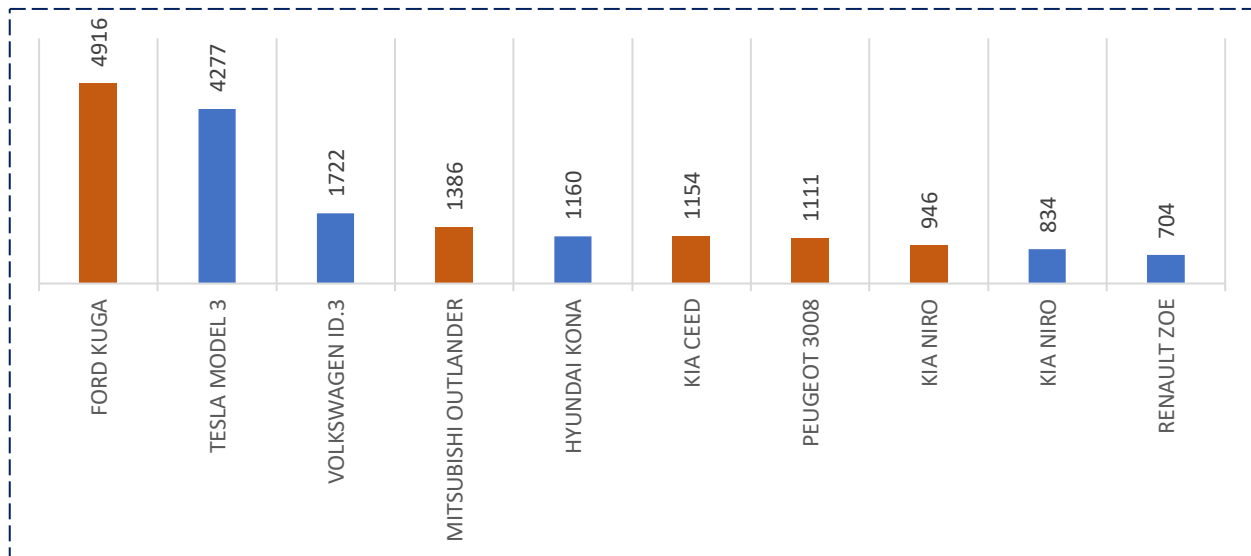

Figure 7.5: EV sales in 2020 by model type, (blue is BEV and beige is PHEV) (DBI, 2021)

7.5 EV integration

In November 2017, Denmark introduced a voluntary billing mechanism where the electricity price is raised during evening peak hours (17:00 and 20:00) and lowered during off-peak hours. Electricity consumers incur spot-market-based pricing through the monthly average wholesale price.

In Denmark companies have already started the provision of ancillary services (specifically FCR-N) from EV fleets. The aggregation of charging/discharging from the connected EV storage through bidirectional charging have been used for the provision of frequency reserve.

7.5.1 True Energy ApS

True Energy controls the charging of EV fleet using an app, which collects information such as expected time of departure, minimum state of charge requirement etc (Ramboll, 2019). This information is then used by True Energy's Energy Management Server to control the charging of the EV as shown in Figure 7.6.

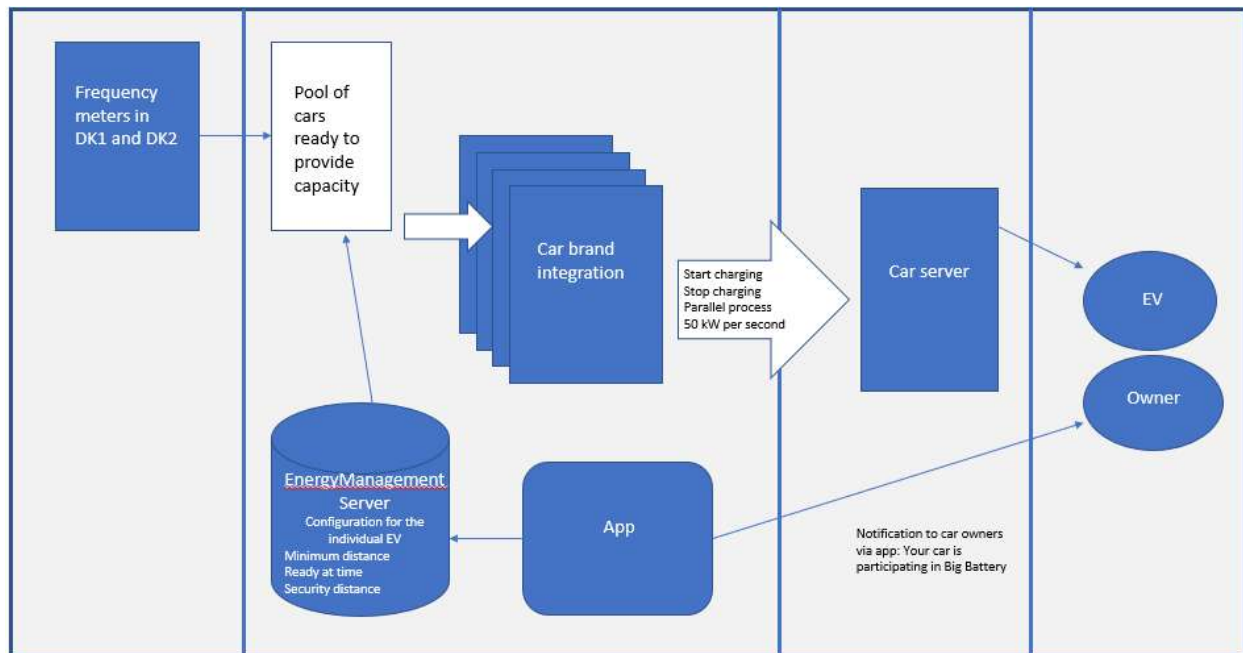

Figure 7.6: Use of EV for provision of FCR-N services as performed by True Energy (Ramboll, 2019)

Based on the frequency measurement, the reserve from EV's are activated when the frequency reaches threshold value ($49.9\text{Hz} < f < 50.1\text{ Hz}$). The frequency reserves are activated under the following conditions:

- When the activation period starts, several EVs corresponding to the offered reserve will start charging
- If the frequency drops. The EV's charging is proportionately reduced (or turned off) until the frequency measured is again in the acceptable range.
- If the frequency increases, more EV's are turned on for charging.

However, a few challenges were experienced in the implementation of the service as listed under

- Technical challenges
 - Getting responses from the EV's and servers, that were fast enough to provide frequency regulation within the time limits of the specific services
 - The development of algorithms, that included the users' needs and behaviors, the demand from the TSO and the varieties of the EV's
- Market issues
 - Having enough EVs under management in order to be able to bid the minimum capacity.

7.5.2 Barriers in the implementation of V2G technology in Demark

Although different pilot projects have shown the feasibility of V2G, the commercial implementation of V2G is still lacking. West Denmark commonly known as DK2, has a significant need for flexibility capacity and the fleet aggregators have a good potential to serve the Danish TSO in providing frequency regulation services. However, different obstacles such as high electricity prices, lower stock of EV fleet and dual taxation on EV charge and discharge have affected large scale commercialization of V2G technology. The different barriers are described below (P. B. Andersen, Toghroljerdi, Sorensen, et al., 2019).

Economic factors

Although V2G is a valuable flexibility resource to the TSO, there are economic barriers as summarized in Table 7.2.

Table 7.2: Economic barriers for V2G implementation

General barriers	Market reform	Current bidding rules are not effective for small scale fleet aggregators
	System investment	There is significant cost associated with the upgradation of monitoring and metering systems
	Emerging market	Public distribution level market is necessary to realize various V2G services for DSOs
National barrier	Dual taxation	High tax rate for both V2G charging and discharging limits V2G cost effectiveness.

Primary frequency reserves in Denmark are asymmetric bids, which are preferable to the V2G aggregator, but the threshold of Frequency Containment Reserve (FCR) bid size (0.3 MW) in a

period of 4 hours is a significant barrier for small scale fleet aggregators. This bidding limit decreases the interest of small-scale V2G aggregators to engage in FCR market.

Another critical barrier is the high EV charging cost and the dual taxation for both EV charging and discharging. The Danish electricity price is approximately INR 27.27 (EUR 0.309)/kWh including taxes and VAT in 2016 which accounts for 67% of the total electricity price. This high taxation has made it challenging for V2G aggregators to make an economically profitable business model.

Technical barriers

Currently only the CHAdeMO protocol-based chargers are capable of providing bidirectional capability. In order to have bidirectional power, both the EV and the EVSE should be capable of bidirectional support. This decreases the total number of EVs that are capable to provide V2G services. The limited number of EVs available to provide bidirectional support is one of the main reasons why V2G has not seen large scale commercial implementation.

Another concern is the battery degradation due to larger number of charge cycles when providing V2G services. It is now quite well known that the increased number of charge cycles have a detrimental impact on the battery lifetime. However, the impact of battery degradation is not so straightforward as several studies have also pointed out that by maintaining the battery SoC at an optimal level and by cycling the battery charging around this optimal point can in fact prolong the battery life. The insecurities regarding the impact of battery lifetime due to bidirectional power flow has thus reduced the interest both from the manufacturers as well as EV user's perspective.

Table 7.3: Technological barriers for V2G

General barriers	Discharging capability	All the EV models are not designed to provide bidirectional power flow
	Battery lifetime	Insecurity about battery degradation due to V2G
National barrier	Small market	The limited number of EVs on the street that can provide bidirectional power

Social barriers

The integration of V2G in the Danish grid is also influenced by some social factors, such as customer interest, opinions, and attitude. One of the social barriers for the Danish population is their awareness of the high taxes for EVs. However, the most challenging barrier is the EV owner's need for minimum energy in the EVs for their travel needs. As the primary use of the EVs are to

fulfil the transportation needs of the user, so range anxiety is a pertinent issue for UV users. In this regard the grid operators or charge management utilities have to ensure the EV users that by participating in V2G services, their travel requirements would not be affected.

Table 7.4: Social barriers

General barriers	User behaviour	Consumers need guidance and directions to make them acceptable of the new technology
	Trust in technology	The technology must be able to give customers the confidence that their travel needs would not be affected
	Complexity of business models	The customers are also not likely to participate in V2G services if the terms and conditions of the business models are too complicated.
	Financial incentive	Participation in V2G services must give the customers a minimum amount of financial incentive in order to motivate them
National barrier	Lack of government support	Lack of communication about V2G and its opportunities for the society
	Lack of communication	Lack of Danish subsidy for purchase of EV results in lack of public support

Profitability of smart charging at system and distribution level

A 100%EV penetration scenario has been analyzed for the island of Bornholm in Denmark (Marinelli et al., 2020). The EVs are subject to different charging strategies in order to assess their grid impacts and also the potential savings on the charging costs. The island has an interconnection with Sweden for emergency imports.

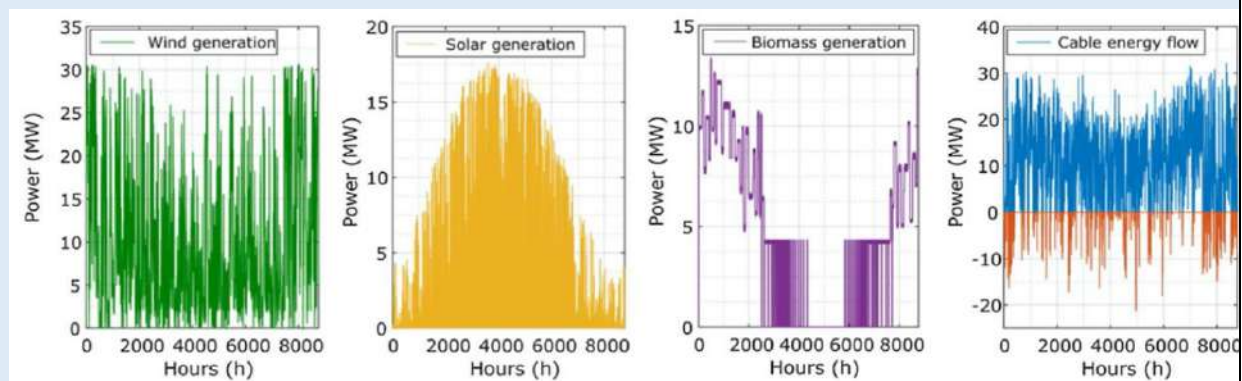

Figure 7.7: Hourly generation of RE sources in the island and flow in the interconnection with Sweden (Marinelli et al., 2020)

In the uncontrolled charging case, the EVs start charging immediately when the users plug-in their EVs. In the Demand Side Management (DSM) strategy the charging is optimized based on the Time-of-Use tariffs

and in the V2G strategy charging and discharging have been optimized considering the dynamic electricity prices.

In the uncontrolled charging case, there is no optimization over the import of power from Sweden. Whenever the loads are not met by the local generation, the power is imported from Sweden. This leads to the island importing energy from Sweden for the majority of hours of the year. The resulting annual costs for the three different charging strategies have been given in Table 7.5. As expected, the uncontrolled charging has the highest annual costs. Smart charging strategies bring a reduction of almost 12% over the annual charging cost for uncontrolled charging. Moreover, a limited benefit for bidirectional charging is seen, there is a need for an analysis to verify if the added strain due to V2G is justifiable considering the marginal savings.

Table 7.5: Cost comparison of annual charging cost for different charging strategies

Consumer	Charging Rate	Cost of Uncontrolled charging per year (INR/EUR)	Cost with DSM per year (INR/EUR)	Cost with V2G per year (INR/EUR)
Household consumer	1-phase	78,021/ 885.79	74,314/ 843.71	74,278/ 843.30
EV User	1-phase	34,427/ 390.86	30,436/ 345.549	30,116/ 341.916
EV User	3-phase	34,166/ 387.89	30,388/ 345.00	29,583/ 335.86

Economic value of frequency regulation with EVs

EVs can be used for providing frequency regulation service (FCR-N) which is an ancillary service product in Denmark. This can be provided by EVs in two ways: either by controlling their charging power i.e., unidirectional or by providing bidirectional support.

Unidirectional FCR-N can be provided by any domestic charger but with the capability of modulating charging power set-points based on input sent by some controller, thus the added hardware cost is limited. Unidirectional charging is limited by the amount of energy it can provide to the FCR-N services it has to maintain a minimum amount of energy to fulfil the EV users travel requirements. Delivering FCR-N services for 3-4 hours in the night when the ancillary prices are the highest would result in a yearly revenue of INR 4618 (EUR 52.43) to INR 6217 (EUR 70.58).

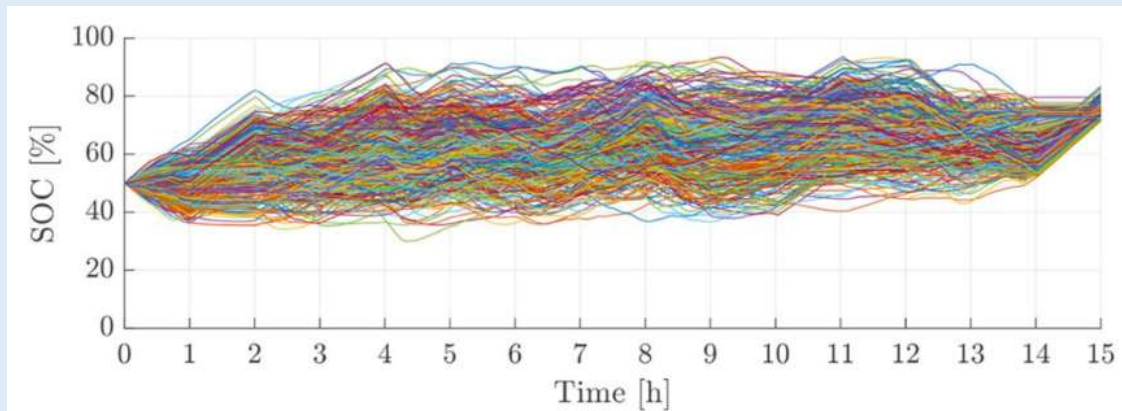

Figure 7.8: SOC evolution when delivering FCR-N with +/- 6.9kW pf regulating power. Every line denotes a different session (Marinelli et al., 2020)

Bidirectional charging however removes the limitation on the amount of energy that the EV can provide for FCR-N services over a time period as it can deliver as well as consume the same amount of energy bringing its net energy transmitted very close to 0. It is therefore only limited by the number of hours it remains plugged-in to the grid and the power rating of the charger. A 10kW CHAdeMO charger with bidirectional support has been utilized to provide FCR-N support in this study. Considering the EV is parked for 15 hours daily, the total annual revenue that it can achieve is INR 1,23,900 (EUR 1406.67). However, due to frequency bias, by providing FCR-N services at full +/- 10kW of regulating power may either completely deplete or completely charge up the battery for as much as 88% days of the year. For this reason, the regulating power has been optimized as +/- 6.9kW which maintains the SOC of the battery within acceptable limits as shown in Figure 7.8. Considering +/- 6.9 kW of regulating power, the yearly revenue has been calculated as INR 98,320 (EUR 1116.257).

Nuvve

Category: Nuvve primarily caters to private fleets and offers bi-directional charging solutions to its consumers. The company operates in Denmark, France, UK, USA, Belgium, and Italy.

Services: Nuvve provides grid integrated vehicle platform for V2G (V2G-Give) that consists of a smart bi-directional charger and EV management software for V2G (NERA-Nuvve energy regulation aggregator). The company focuses on reducing charging costs for fleets with aggregated V2G service provision.

Partnership: The company has partnerships with fleet operators and Network companies for providing V2X services. These include partnerships with Dreev and EDF.

7.6 Case Studies

7.6.1 The Parker project

Project Category: Research and demonstration Project

Project duration: August 2016 to July 2018

Project aim: This project demonstrated the potential for EVs to provide grid frequency response services. Fifty charging points were provided by ENEL and the aggregation software by NUVVE (Andersen et al., 2019).

Project Overview:

The project investigated the V2G applications and provision of ancillary services to power systems. A key feature of the project was the compilation of potential power and energy services in a service catalogue. It was demonstrated that the project vehicles and charging infrastructure is presently technically able to provide all frequency regulation services used in Denmark.

In addition to FCR-type services, the project also investigated the Frederiksberg Forsyning (FF) commercial V2G hub. The FF site is an actual operational customer site consisting of 10 Nissan e-NV200 EVs and 10 Enel V2G chargers. Each charger had a minimum and maximum power rating of +/- 10kW.

Frequency Regulation Service

Frequency-controlled normal operation reserve (FNR) is a service in which the contracted generation and load are continuously controlled to keep the frequency under stable operating limits (Arias et al., 2018). In Denmark, the FNR is procured one or two days ahead of the day of actual delivery. Hourly bids are submitted via the self-service portal of Energinet, the Danish national TSO. Moreover, according to the Danish market regarding FNR only symmetrical bids are allowed, which means that the up and down regulation services must be provided together and the minimum bid for participation in the market is 0.3MW. Thus, for participating in this market the EVs are required to serve as both production and consumption units, i.e., they have to charge/discharge based on the regulating signal.

The EV fleet in FF provided FNR services to Energinet through an aggregator. The EV fleet was part of a public utility company (Frederiksber Forsyning) in greater Copenhagen. The aggregator plays a key role in aggregating the individual which included the responsibility to bid into the market and after the acceptance of bids, schedule the EV fleet operation following the frequency

signal. The aggregator receives the frequency signals from the DEIF MTR-3 device on a per second basis. Based on the frequency signal received, the preferred operating point of each EV is determined based on the EV state of charge. The FNR response for each EV is governed by the droop control as shown in Figure 7.10. The change in charging power is governed by the deviation of the frequency from the nominal and also by the gradient of the droop. It can be observed from Figure 7.10 regulation service providing entity (EV fleet) has to provide/consume entirety of its bided power capacity when the frequency deviation reaches ± 0.1 Hz.

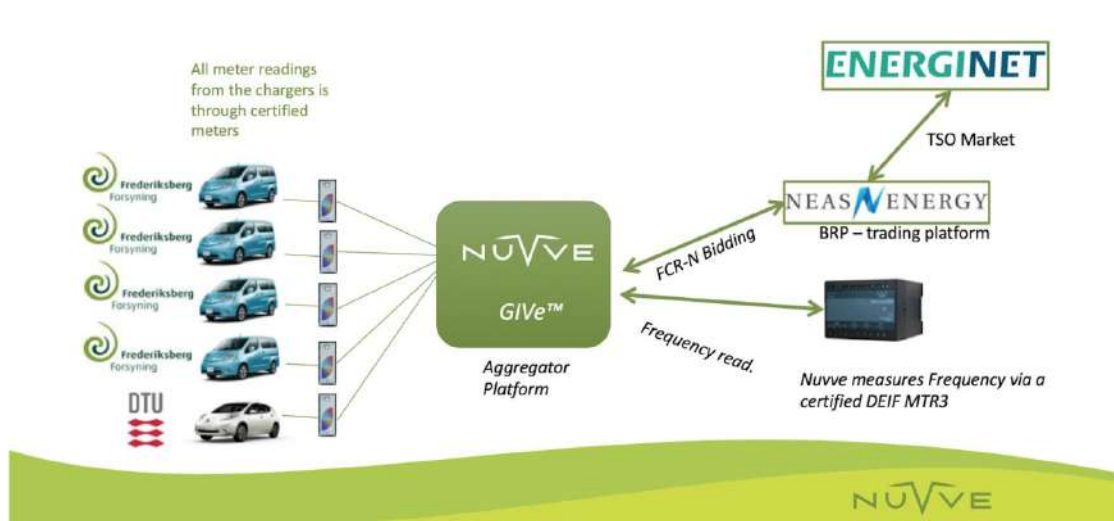

Figure 7.9: Project architecture for FNR services (P. B. Andersen, Toghroljerdi, Meier, et al., 2019)

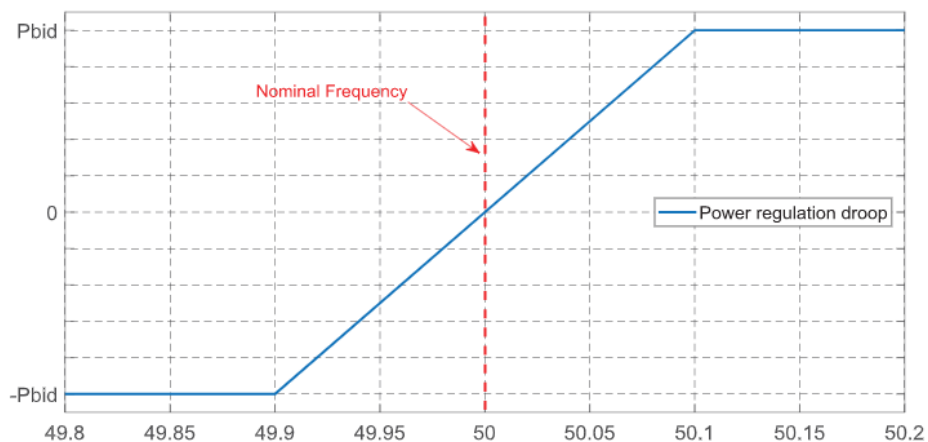

Figure 7.10: Droop control for FNR service (Arias et al., 2018)

Figure 7.11 shows the FNR service provided by each individual EV, and it can be observed that for over frequency, the charging load of the EVs increase proportionally. Similarly, for underfrequency case the EV goes into the discharging mode

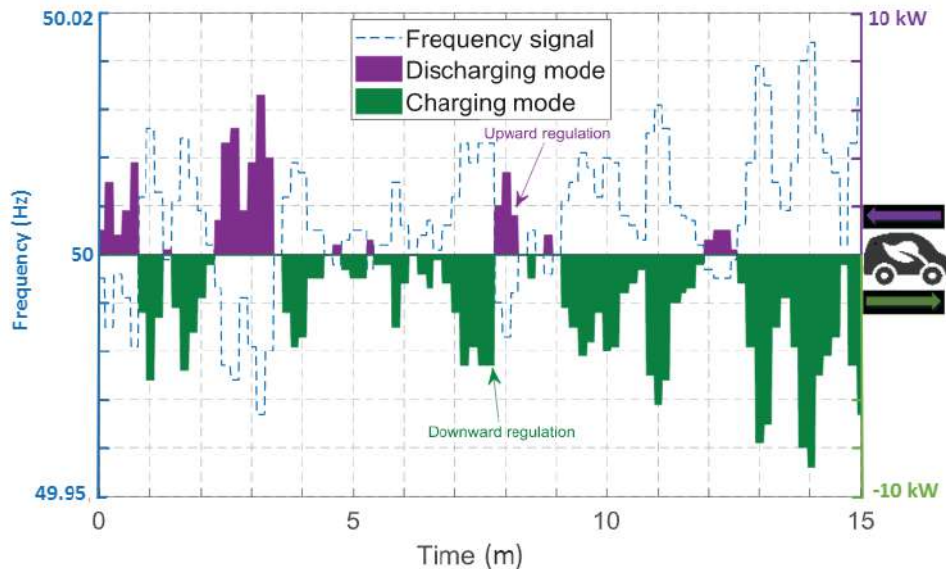

Figure 7.11: FNR service provided by an EV (Arias et al., 2018)

Figure 7.12 shows the difference between the requested response and the actual response. Based on the high-resolution data it can be seen that the actual power curve slightly differs from the requested power curve both in terms of time and magnitude. The differences may be the results of the delays in the EVSE response, communication delays, physical and technical constraints of the equipment such as the current steps of the charger. However, the time delay is less than 10 seconds which shows that a very fast regulation is provided compared to the FNR regulation requirements.

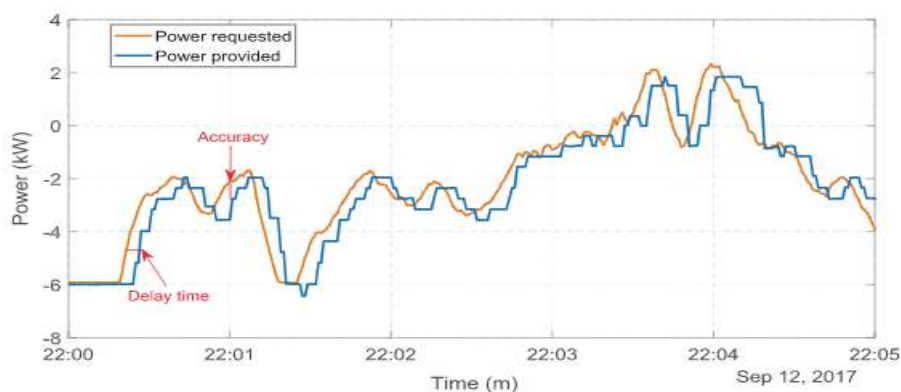

Figure 7.12: Time difference between power requested and power provided for one EV (Arias et al., 2018)

Key requirements for V2G operation

The project's second objective was the development of a test protocol aimed at the technical capabilities needed in EVs and charging infrastructure in order to support V2G and the services listed in the service catalogue. For this purpose, the project recommended a framework to understand the requirements for EV to be fully integrated in the power system. The three main verticals of this framework are:

**7.6.1.1.1 Controllability attributes**

The controllable parameters of an EV are given in Table 7.6. Active and reactive power control are used to provide grid support services. The mode of operation of the EV i.e., if the EV is in grid forming or in grid following mode also needs to be controlled for either parallel operation with other generators or for an islanding operation.

Table 7.6: Controllability attributes

Name	Description	Units
Active power	Unidirectional/ bidirectional	W
Reactive power	Inductive/ capacitive	VAR
Operation	Grid forming/ grid following	

7.6.1.1.2 Observability Attributes

In order to properly control the EV integration, the different status of the grid and EV needs to monitor such as exchange of power and energy, status of battery, state of charge or battery, active power setpoint for charging etc. Observability covers all these aspects which needs to be measured for effective EV integration.

Table 7.7: Observability attributes

Name	Description	Units
Battery energy status	SOC and battery capacity	Wh
Power status	Active and reactive power injected or drawn	W, VAR
Voltage and frequency	Measured at EV and EVSE	V, Hz
Vehicle and connection status	ID and plug-in state	ID, Status

7.6.1.1.3 Performance indicators

In order to perform the grid support services effectively, different performance indicators need to be monitored as listed in the table below

Table 7.8: Performance indicators

Name	Description
Directionality and granularity	Setpoint range and step size
Responsiveness	Latency, activation and ramp time
Accuracy and precision	Delivered vs requested response

Project Results:

Key project outcomes included the validation of technical feasibility of project EVs and charging infrastructure to provide advanced services to the grid as well as project scalability. The scalability of V2G operation of EVs for provision of FCR service, independent of OEM, TSO regions and battery sizes have also been validated. The study also concluded the incorporation of ability of altering power setpoint, access to battery SoC and identification of vehicle from EVSE as important parameters that needs to be considered while designing of standards for seamless integration of EV into the grid.

Key Learnings:

The project validated the effectiveness of the Parker portfolio of EVs to support the grid through V2G. The field-test in Copenhagen demonstrated the commercial viability of the technology. However further steps must be taken to allow for universal support of V2G and VGI services across all EV brands, standards, and markets.

Several policy recommendations were suggested.

- Denmark should have a clear and consistent plan towards full electrification of the transportation sector.
- Research, development and demonstration, National funding programs, such as EUDP and Innovation fonden, should consider emphasizing V2G research as an area of interest.

- International collaboration is also key in advancing V2G technology, both within market and standard harmonization.

7.6.2 Electric Vehicle Fleet Integration in the Danish EDISON Project – A Virtual Power Plant in the Island of Bornholm

Project Aim: The Danish EDISON project has been dispatched to explore how a huge armada of electric vehicles (EVs) can be coordinated such that it upholds the electric grid while profiting both the individual vehicle proprietors and society all in all through decreases in CO₂ discharges.

Motivation: In a VPP, on the off chance that an armada of EVs can be overseen properly, a huge portion of such vehicles can turn into a resource for the electric network. The electrical burden can be moved on schedule, and extra EV battery energy could be given back into the electrical grid.

Operational Constraints tackled:

- The issues to accommodate the increased load in the electric grid while acknowledging grid constraints, production, and consumption.
- Giving a time-of-day evaluating of power to move charging occasions to off-top hours around evening time and in this way balance the grid

Project Summary:

The task researched V2G advancements and showed the Electric Vehicle Virtual Power Plant (EVPP) stage on the Danish island of Bornholm (Binding et al., 2010). Efforts are to keep the idea appropriate in any place where EVs (counting absolute electric vehicles (EV) or plug-in hybrid EVs (PHEV)) are to be presented with most extreme advantages for all partners.

A regularly acknowledged technique is to total the EVs and sustainable power assets into virtual power plants (VPP). A VPP depicts an accumulated framework where many Distributed Energy Resources (DERs) with small power generation output are partly or fully controlled by a single coordinating entity.

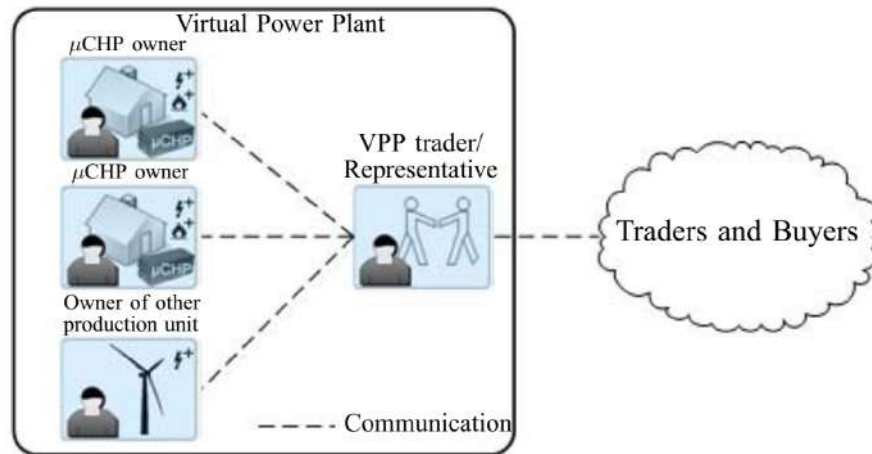

Figure 7.13: The VPP concept (Binding et al., 2010)

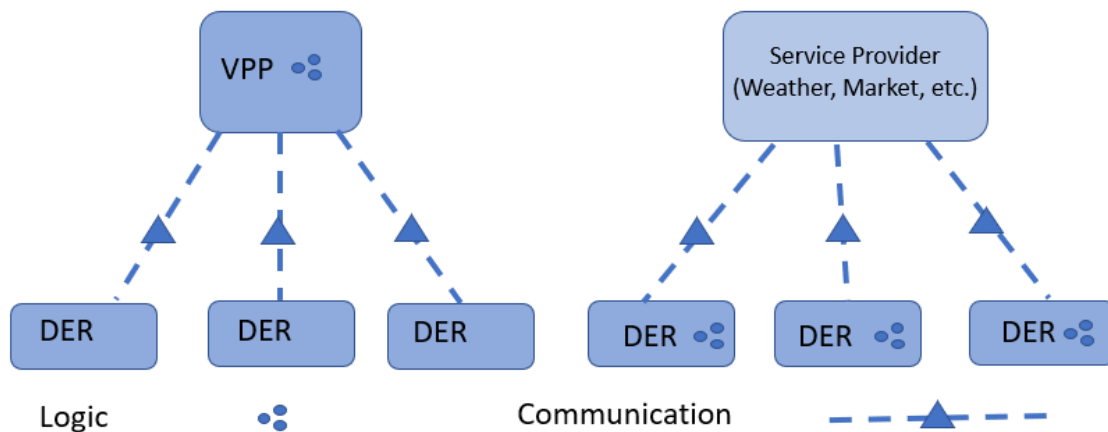

Figure 7.14: Centralized vs distributed VPP (Binding et al., 2010)

VPP can act commercially to earn money for its members, or it can help in grid support based on the purpose VPP is made. Generally, VPP encompasses all kinds of DERs, but EDISON Electric Vehicle Virtual Power Plant (EVPP) considers EVs as DERs. EVPP can support fast and controlled charging stations. EVs are not considered batteries for prolonged duration, rather the intelligent charging with logical decisions based on grid conditions with sufficient connection time to EVs will allow grid balancing.

Layered VPP structure:

For both the European and Danish force frameworks, a two-layered structure is seen as shown in Figure 7.15 . The electrical layer comprises power plants, wind farms, high-voltage transmission frameworks, low-voltage distribution, and metering. This space can be viewed as a specialized foundation with related physical and designing requirements, yielding a huge and solidly coupled

framework. On top of the specialized foundation layer, commanded by strategically and economically motivated deregulation efforts, we see the power market layer. There, electrical energy is exchanged as commodity on trades, for example, Nord Pool or the European Electricity Exchange (EEX), and it permits energy dealers to purchase and sell energy without buying or working any of the grid infrastructure.

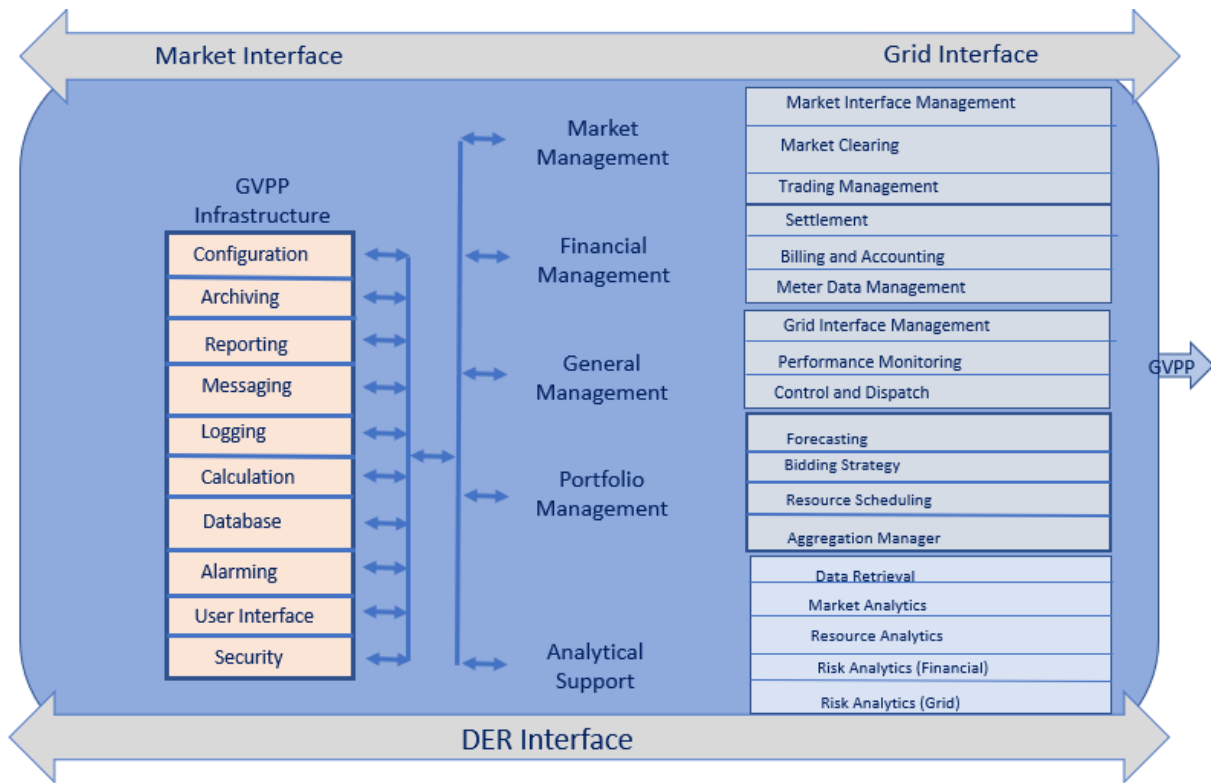

Figure 7.15: Function based design for VPP (Binding et al., 2010)

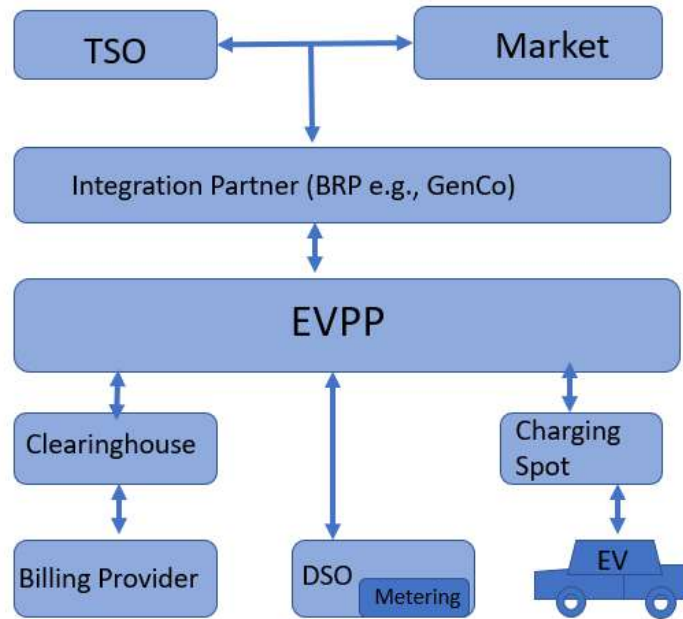

Figure 7.16: Environment Diagram of Integrated EVPP (Binding et al., 2010)

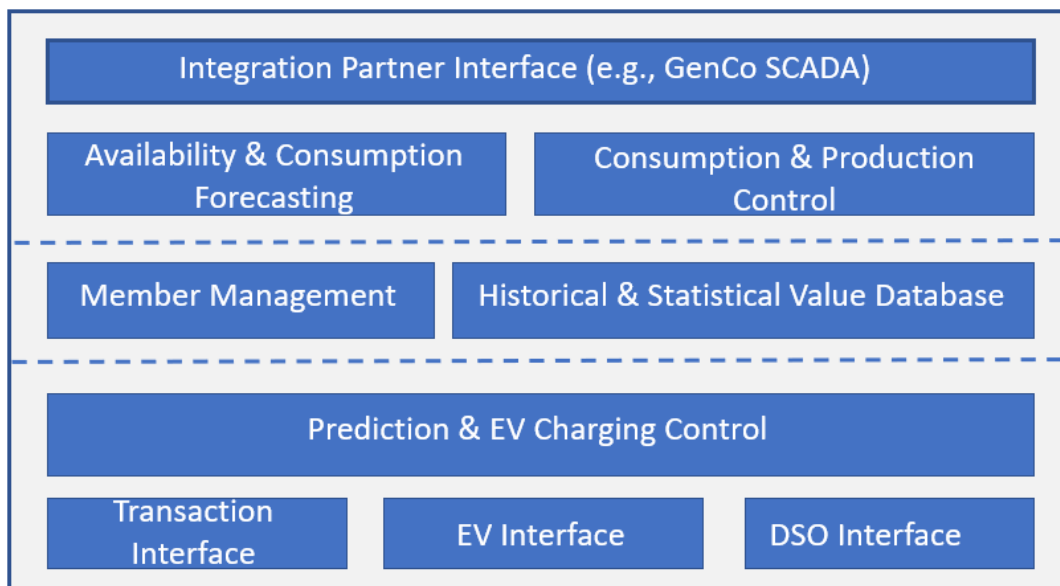

Figure 7.17: Module Diagram of EVPP (Binding et al., 2010)

The EVPP Integrated model allows involvement of the EVPP into already existing market player like Power plant or any third party (termed as Balancing Responsible Party (BRP)). This architecture provides the integration company with a tool that manages their committed energy schedules and also acts as the ancillary, balancing, services market for spare capacity.

Both EVPP concepts contain three different module groups:

1. The benchmark group for a solitary EV
2. The data storage and member management group
3. The aggregation and partner interface group.

In the integrated approach data for market price prediction and the associated information is delegated to the associated SCADA by which the parent company can exercise its control. The single-EV control module group, which manages individual EVs, consists of four different modules that handle all needs of a single EV in terms of charging, feedback, accounting, and charging prediction.

The Prediction and EV Charging Control module is the primary module in the single EV control group of the EVPP, which determines/predicts when a EV will connect to a specific charging point based on historical statistical data. Based on the forecast, the module optimizes the charging schedule, taking into account the charging price, grid constraints and the EV user needs. When EV is connected to the EVPP, the Prediction and the EV Charging Control Module crosschecks the EV state and the grid state with the prediction values. If there is a positive match between the actual values and the predicted operational parameters, the optimal charge schedule to the EV. However if there is a misalignment between the predicted values and the actual values (such as fast charge requests, connection time, SoC etc.) the module will determine a new charging plan and send it to the EV.

In the coordinated methodology information for market value expectation and the related data is assigned to the related SCADA by which the parent organization can practice its control. The single-EV control module bunch, which oversees singular EVs, comprises of four unique modules that handle all requirements of a solitary EV as far as charging, input, bookkeeping, and charging expectation.

The main module in the single-EV control gathering of the EVPP is the Prediction and EV Charging Control module. Considering statistical records and history, this module predicts when a particular EV will interface with a charging spot and the necessary energy measure to be charged. The expectation likewise incorporates the accepted association and accordingly the charging time and the present status of the charge. In view of these estimates, the module ascertains an ideal charging plan, which considers the charging cost and the matrix limitations in regard to control bandwidths. If an EV interface with the EVPP, the module first checks whether

the EV state and matrix state coordinates with the expectation and if so, the module sends the precalculated, streamlined charging plan to the EV. In the event that the association time, condition of charge, network state, or EV administrator necessity (e.g., quick charge demand versus anticipated smart charge demand) do not follow the expectation, the module will compute another charging design and send it to the EV. The changes will be put away in the information base as a contribution to preparing the forecast module.

The data storage module bunch contains two modules, the Historical and Statistical Values Database, which is utilized by the Prediction and EV Charging Control, the Consumption and Production Control, the Availability and Consumption Forecasting, the Bidding, Buying and Feedback, and the BRP modules. Moreover, the module bunch contains the Member Management module, which empowers an EV administrator to alter their default settings and prerequisites. The Production and Consumption Control module controls the day-by-day activity of the EVPP. On an aggregation, it authorizes consistency with the charging plan concurred and will supersede potential varieties in collaboration with the Prediction and EV Charging Control module. It likewise gets orders from the upper-level SCADA framework to offer auxiliary assistance by means of the Integration Partner Interface, which associates the EVPP with the SCADA framework. The Balance Responsible Party module upholds the BRP in making and submitting compulsory timetables to the TSO through the TSO Interface. This interface is likewise utilized by the TSO when sending initiation orders for acknowledged subordinate assistance offers. These TSO orders are prepared by the Consumption and Production Control module.

The Danish Island of Bornholm has been chosen as re-enactment situation for EDISON WP3 on the grounds that it is anything but a small grid with the choice of working in island mode and with a high wind power infiltration. The ØSTKRAFT organization is the conveyance framework administrator (DSO) just as the producing organization on the island, providing in excess of 27,000 clients.

The production capacity is as follows:

- 14 diesel generators (oil): 39 MW
- 1 steam turbine (oil): 27 MW
- 1 steam turbine (oil/coal): 37 MW
- 35 wind turbines: 30 MW
- 1 gas turbine (biogas): 2 MW

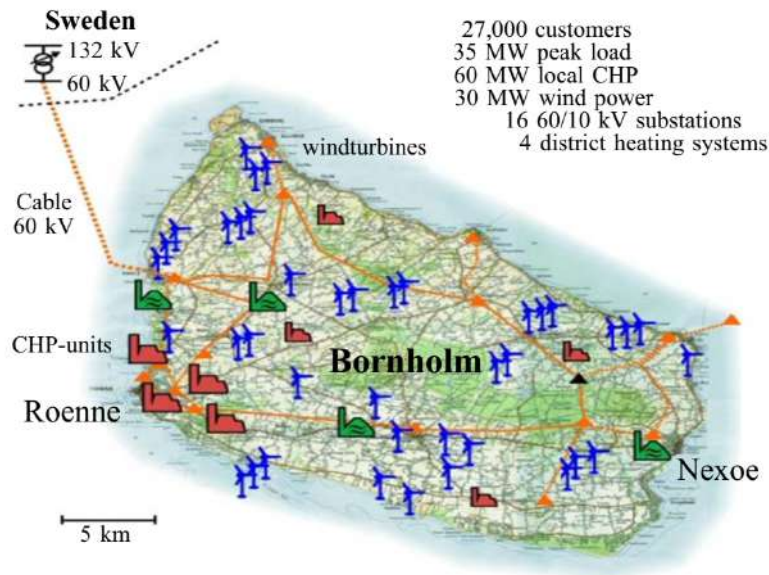

Figure 7.18: Bornholm 60 kV Distribution Grid (Binding et al., 2010)

The distribution infrastructure of Bornholm can be split into 60 kV, 10 kV and 400 V as three distinct voltage levels. An important issue seemed to be the notion of *location*. Managing both traffic and electrical aspects are key areas in this study. The EVs travel between locations consuming some electrical power average. In future there is scope to improve Forecasting and optimization. The simulation aims to gather maximum data before the implementation. For this purpose, maximum real-time situations are considered for simulation.

The project is now able to simulate the grid's load-flow with associated EV charging and this is computed at 15-minute interval to assess the load on transmission lines and transformers. The generated and the consumed power is balanced by curtailing the renewable energy generation with the simulation output shown in Figure 7.19. This represents the temporal evolution of the power generation and demand with a focus on EV charging.

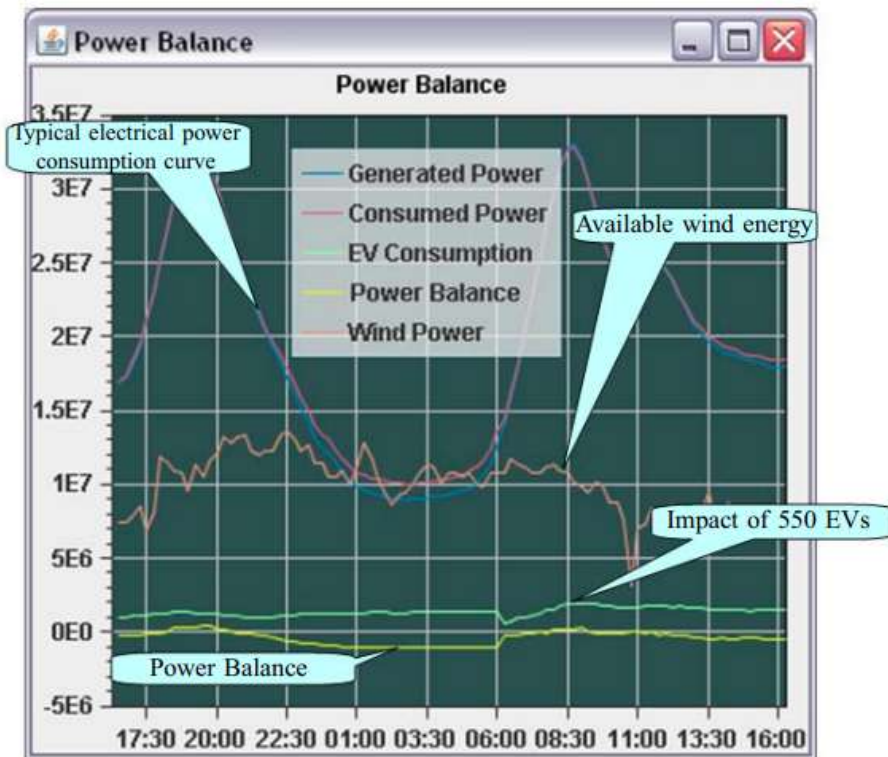

Figure 7.19: Generation and Load visualization (Binding et al., 2010)

Key Takeaways:

- This scalable platform is able to interface with the power system infrastructure and power market stakeholders when planning the operation of a fleet of EVs. Efforts are in direction to make this platform universally acceptable.
- Respecting grid constraints, production constraints, consumption along with minimizing costs of fleet charging is made possible in various optimized ways.

Integrated and stand-alone architecture make this platform flexible for its adaption under various commercial cases. Complete flexibility of commercial and grid support EVPP concept could be exercised.

Chapter 8. Norway

8.1 Background of EV policies

The achievement of Norway having the highest per capita share of EVs can be linked to its well-structured policies and regulations that have evolved over the years. In the early 90's the policies were targeted to enable the testing and evaluation of low carbon transport by removing the EV vehicle purchase tax. This was soon followed by the exemption of VAT to boost the local EV sales. Towards 2010, the EV policy focus was shifted towards reducing greenhouse gas emissions. Post 2010, Norway experienced a sharp increase in EV fleet, which can be attributed to the launch of high number of EV OEMs, that brought the EV prices down (Fearnley et al.,

2015). The historical development of EV policies in Norway is summarized in Table 8.1. A yearly EV owners survey by the Norwegian EV Associations provides insight into the minds and preferences of the EV users, which has concluded that the three EV policies most valuable to EV users are the *Exemption from VAT*, *Exemption from road toll* and *No purchase tax*.

- Norway has the highest share of EVs per capita throughout the world.
- The country has approximately 16,000 charging points which accounts for more than 9% of the total charging stations in Europe.
- At the European level, the Directive on the deployment of alternative fuels infrastructure (EU, 2014) requires members to ensure an appropriate number of recharging points that are accessible to the public. The Directive also indicates one recharging point per 10 EVs as an appropriate average level and requires each member states to facilitate deployment of EV charging

Table 8.1: Historical development of EV policies in Norway (Haugneland et al. 2017)

Incentives for zero-emission vehicles	Year of Introduction
No purchase tax	1990
Low annual road tax	1996
Exemption from road toll	1997
50% reduced company car tax	2000
Exemption from VAT on purchase/leasing	2001/2015
Access to bus lanes	2003
Free access on state ferries	2009

8.2 EV Charging infrastructure policies and regulations

Table 8.2: EV Charging infrastructure policy in Norway

Policies Enabling EV charging on supply-side		
Element	Policy Instrument	Measures
The incentive for launching the EV charging market	Financial stimulus package (2009-2010)	<ul style="list-style-type: none"> The support scheme funded 100 % of the installation cost for normal chargers, up to INR 2,56,465 (EUR 2911) per charging point. The total support amounted to INR 42.74 crores (EUR 48.5 million) with around 1800 charge points installed all over the country.
	Government support schemes for fast charging stations (2010-2014)	<ul style="list-style-type: none"> 100 % of installations costs for EV charging operators
Prioritization in terms of EV characteristics and social geography		<ul style="list-style-type: none"> State enterprise Enova introduced a support scheme to cover the Norwegian main roads with fast charging stations every 50 km (around 7500 km road network) According to the different charging efficiency, the state introduced an optional charging prices system. The charging prices of fast charging services are three times higher than low charging at home.
Policies Enabling EV charging on demand-side		
Element	Policy Instrument	Measures
Technical standardization of chargers for interoperability		All locations must have at least two multi standard fast chargers (CHAdeMO and CCS) in addition to two 22 kW Type 2 points.
The mandate for the development of digital platforms and database management systems		Cooperation between the governmental entity Enova and the Norwegian Electric Vehicle Association resulted in the development of an open, publicly owned database that allows everyone to

		build services using standardized data free of charge.
Harmonization of cross-border/cross-provider user registration for accessing charging infrastructure		The Norwegian Electric Car Association (Elbilforeningens) gives users access to charging units all over the country at a reduced price.

Norway has been one of the early adopters of EVs and in the establishment of the infrastructure. On the supply side, the government has incentives in place to promote EV infrastructure, specifically to establish fast charging across long range mobility, although the price differential between fast and slow charging is almost three times. On the demand side, there are two technical protocols in place. In a bid to encourage faster update, EV users can access all charge points across the country at a reduced price.

8.3 EV Charging infrastructure

The technical details of EVSE in Norway are summarized in Table 8.3. As of Feb 2021, there are a total of 2979 charging station in Norway with 18518 total charging points, of which 17124 are for public charging and accessible to all. The share of the different connector types is given in Figure 8.1. Most of the public charging stations are equipped with a Type 2 connector which accounts for around 49% of total charging stations, and 14% of the charging stations are equipped with a CCS2 fast DC charger, while 11% are equipped with a fast DC CHAdeMO charger.

Table 8.3: Technical details of EVSE in Norway(Nordic EV Outlook 2018, 2018)

	Current	Level	Power	Mode	Connector Type
Standard power socket	AC	Level 1	$\leq 3.7\text{kW}$	Mode 1-2	Standard 3 pin plug
Slow EV charger (private or public)	AC	Level 2	$\geq 3.7\text{kW}$ and $\leq 22\text{kW}$	Mode 2-3	IEC 62196 Type 2(7-22kW) Tesla connector

Fast EV chargers (publicly available)	AC Three phase	Level 2	>3.7kW and <=43.5kW	Mode 3	IEC 62196-2 Type 2
	DC	Level 3	>22kW and <=150kW	Mode 4	CCS Combo 2 connector (IEC 62196-3 Type 2) 50kW CHAdeMO (IEC 62196-3 Type 4)50kW Tesla 120kW
Ultra-fast/high-power chargers	DC	Level 3	>150kW and <=350kW	Mode 4	CCS Combo 2 connector (IEC 62196-3) (150-350kW) And CHAdeMO (150-350kW)

Another important metric that needs to be considered in determining the maturity of the EV charging infrastructure is the number of EVs per charge point. In Norway, the sale of EVs is moving at a much higher pace than its public charging infrastructure, which has resulted in an increase in the number of vehicles per public charging point as shown in Figure 8.2. Currently there is almost 30 EVs per public charging point which is much higher than the EU 2020 target of 10 EVs per charging point (IEA, 2021a).

The population density of Norway is relatively lower than many other European countries, and the share of home ownership is also on the higher side. From this it can be inferred that most Norwegians reside in individual private residences, making it easier for them to have their own charging units installed in their homes, which provide the bulk of their EV charging requirements.

However, housing cooperatives and association housing have challenges in installing EV chargers for all of their residences. As per a survey, six out of ten people who live in such housing associations claimed lack of access to home chargers, reducing their likelihood of purchasing an EV. The Oslo Municipality in 2008 became the first to introduce a scheme for installation of chargers in housing cooperatives, by assisting up to 20% of the total cost of setting up a charging station for the housing cooperatives.

Schuko points are normal single phase two pin sockets found in Norway. The earth pins are two flat contact areas on the top and bottom of the plug

(Source:worldstandards.eu).



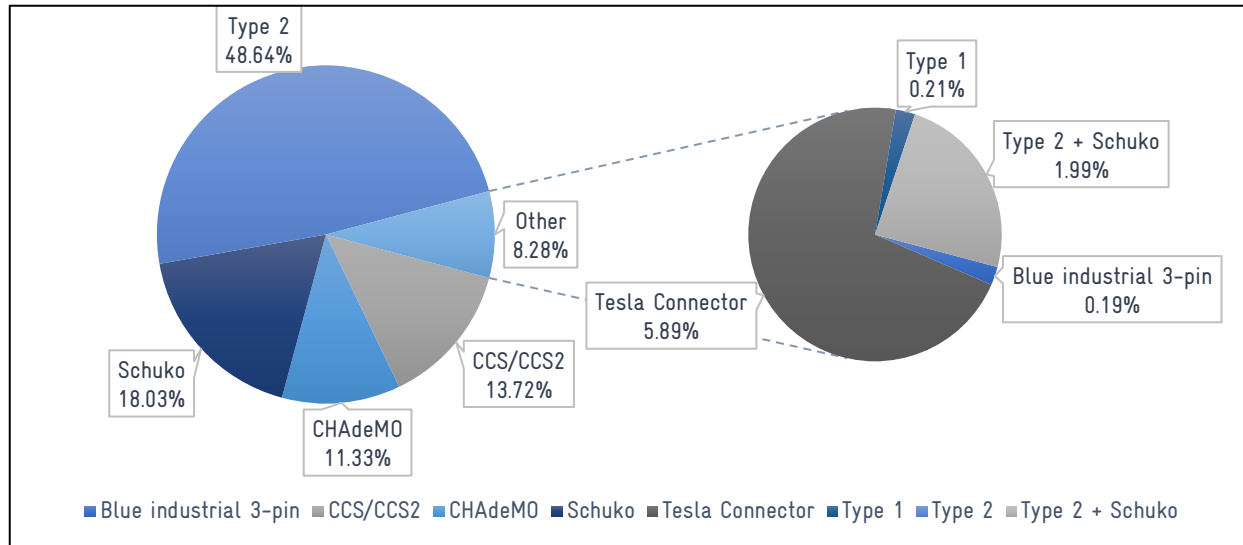

Figure 8.1: Share of connector types among public charging stations in Norway (Statistikk, 2021)

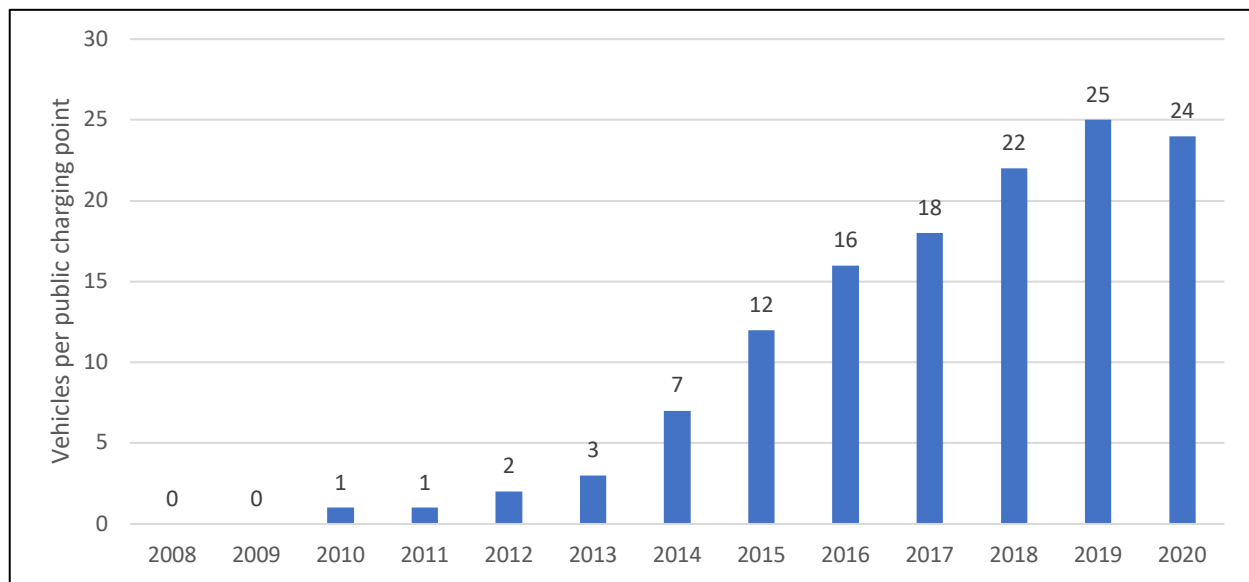

Figure 8.2: Number of EVs per public charging station in Norway (Norway, n.d.)

8.4 EV demand status

Norway is the front runner in terms of share of EV stock. The number of EV's per capita in Norway has been world's highest for several years. The high EV share in Norway can be viewed as a result of national climate policies, as well as Norway's dedication to fulfilling its part of the Paris agreement. Its low EV taxes, toll road exemptions access to bus lanes for EVs, has resulted in Norway having the highest market share of EV worldwide.

Since 2010, Norway has seen a steady rise in sales of EVs, with the sale of battery electric vehicle outpacing that of plugged-in hybrid vehicles as can be observed from Figure 12. By 31st Dec 2020, 346,921 EVs and 142,858 PHEVs have been registered in Norway. With 78,897 more EVs on road in 2020, than in 2019, it gives an increase of around 29.4% for EVs and 23.1% of PHEVs (Haugneland, n.d.). Taking a look at the market share, it can be seen that in 2020, around 54% of all passenger 4W vehicles sold were EVs and 20.4% was a PHEV. Fig.14 shows the sale of BEV/PHEV based on vehicle model. As can be seen the most popular vehicle sold in 2020 was the Audi e-Tron followed closely by Tesla Model 3.

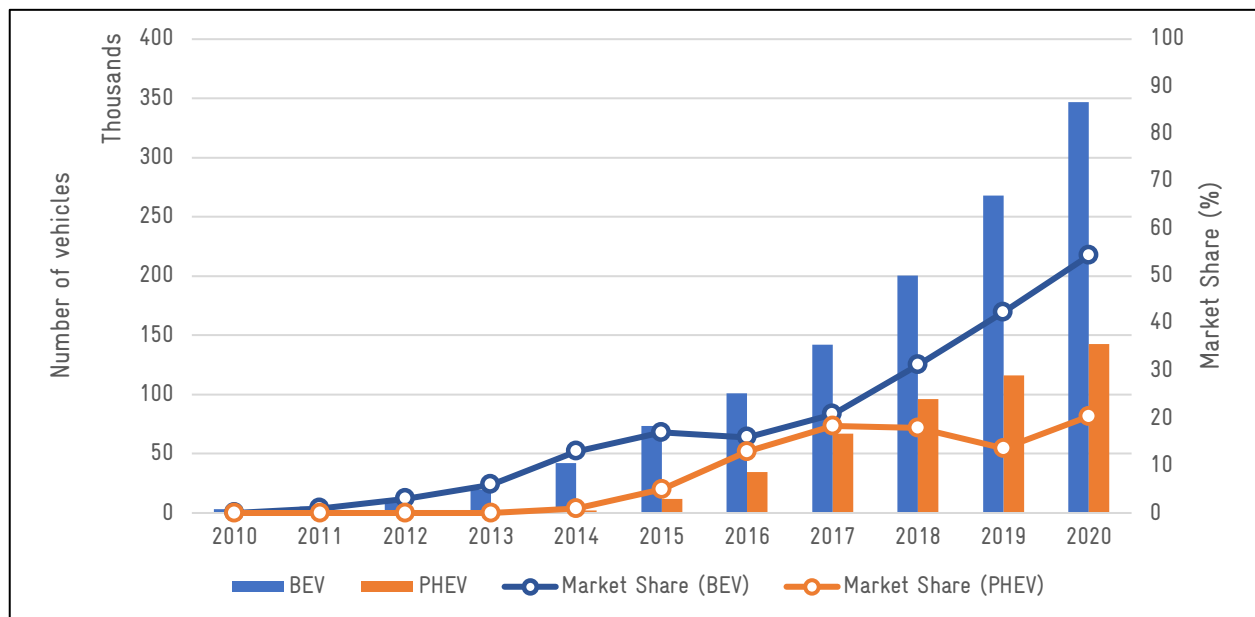

Figure 8.3: Number and Market share of BEV and PHEV in Norway (Number of Electric Cars and Charging Stations in Norway | Norwegian Electric Car Association, n.d.)

Figure 8.3 shows the vehicle stock in Norway, which has been categorized by chassis type and the fuel type. For 2 wheelers and trucks, the market is still dominated by traditional fuel sources, as compared to 4 wheelers. The passenger vehicle stock as per fuel type up to December 2020 is shown in Figure 8.4, and it can be observed that even though diesel and gasoline powered vehicles still has the highest stock at 43% of all vehicles, the electric vehicle segment also has significant penetration as compared to the rest of the countries. The sale of BEV/PHEV in 2020 based on manufacturer make and model is given in Figure 8.5.

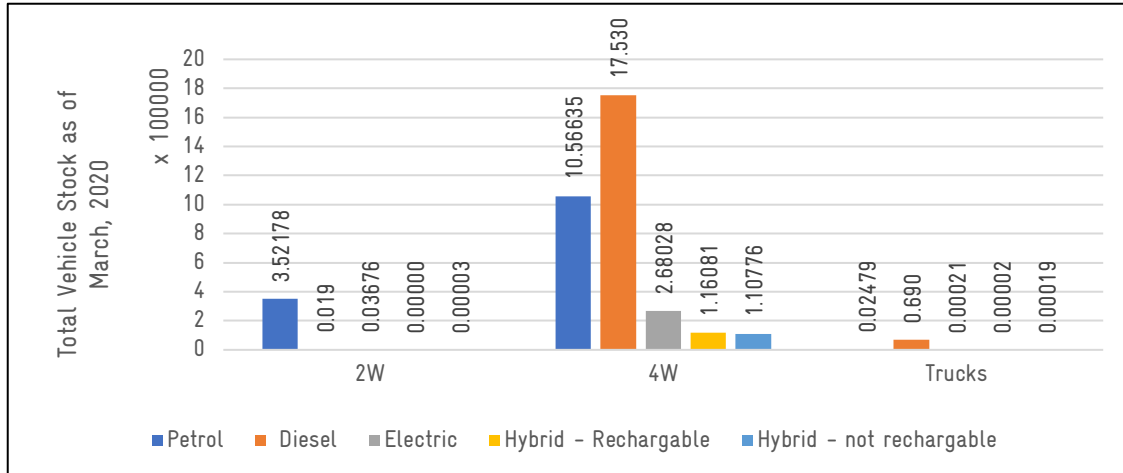

Figure 8.4: Vehicle stock categorized by chassis and fuel type (*Bilparken, n.d.*)

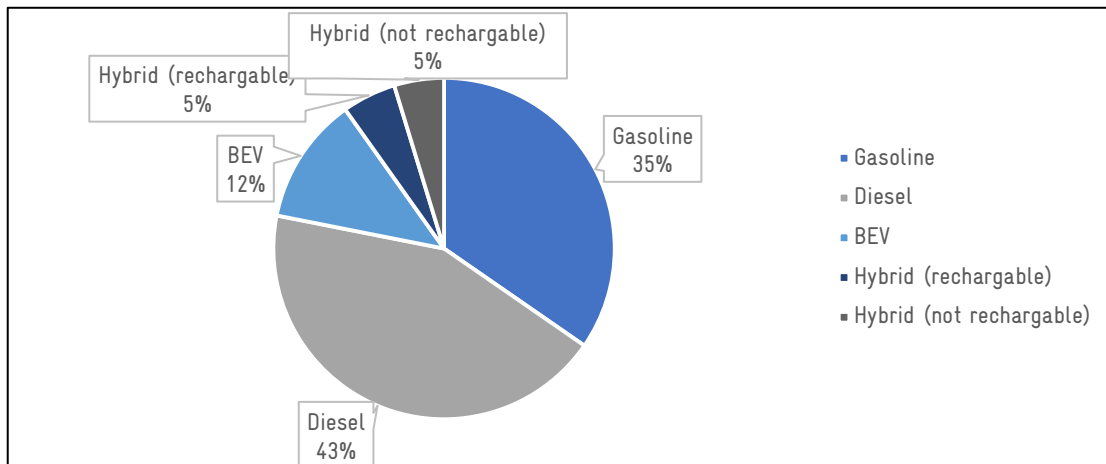

Figure 8.5: Stock of Personal 4 wheeler vehicles by type of fuel till 2020, shown in percentage of total vehicle stock (*Haugneland, n.d.*)

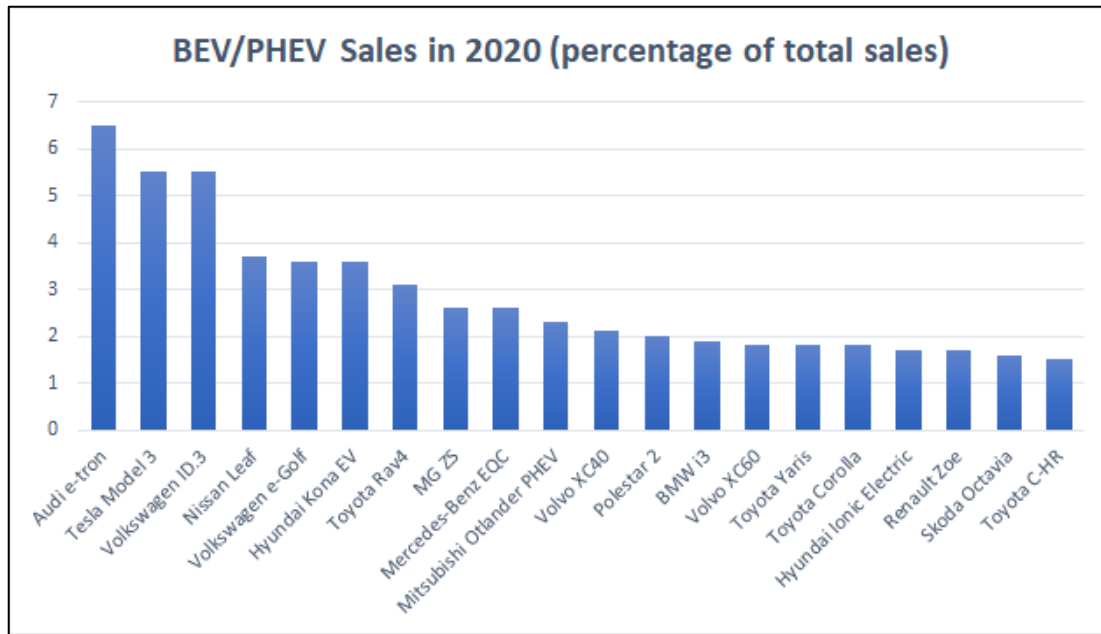

Figure 8.6: BEV/PHEV sales in 2020 based on vehicle make and model (*Number of Electric Cars and Charging Stations in Norway / Norwegian Electric Car Association, n.d.*)

8.5 EV integration

The first roadblock in EV integrations is the increased consumption during EV charging, and its impact on the distribution and transmission network. In 2017, the electricity demand due to EVs in the Nordic countries was 500 GWh, which was negligible compared to its total annual electricity demand (393 TWh in 2018). In Norway, the demand from EV only accounted for 0.14% of the country's annual electricity demand in 2017. If all of 2.7 million passenger electric vehicles were to be electrified, the additional energy demand in the system due to vehicle charging requirements would be about 6.5 TWh, which is 6% of the country's total demand (*Nordic EV Outlook 2018, 2018*).

Currently, in the Nordic region, no significant impact on the transmission level due to EV uptake has been reported, however, some issues in the distribution grid have been reported. In Norway, most individual residential buildings are provided with a 9-15 kW power connection. Since the home charger provided with the newer EVs have a power rating of 3-7 kW, addition of an EV charger for each individual household strains the power connections, unless it is effectively managed. In a typical summer day, the peak demand is generally within the power connection level as shown in Figure 8.7, however, during colder days, the peak demand increases due to utilization of weather specific appliances, such as space heaters, water heaters etc. The use of

EV charger, while other high-power appliances are also being used can exceed the power connection limits. EV owners at home have in fact experienced issues during home charging, with 17% of BEV owners and 31% of PHEV owners experiencing insufficient power for charging. Moreover, 2% of the respondents also experienced a 'burned charge socket', which is a serious fire hazard (*Nordic EV Outlook 2018*, 2018).

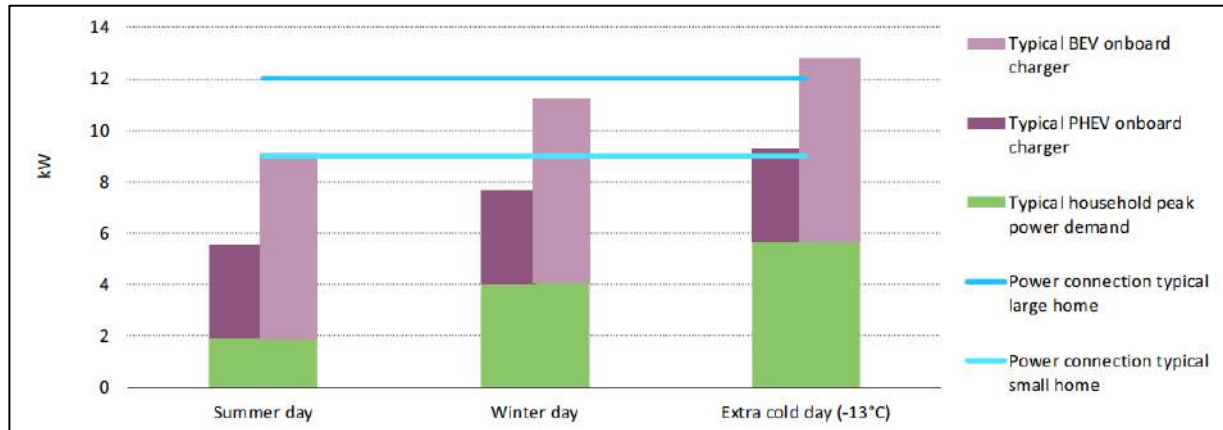

Figure 8.7: Peak electricity demand of detached Norwegian houses with home charging

Norwegian Water Resources and Energy Directorate (NVE) has reported that although a few percent of the transformers are currently operating at the margins or slightly overloaded, an increase in power consumption by 1-2 kW per household would lead to overload in nearly 10% of all transformers. Further, if the average power added to each household is 5 kW, then over 30% of the transformers and 10% of high voltage cables would be overloaded (Jonassen, 2016).

8.5.1 Tariff Structure and Proposed Changes

As per current regulations, the average household in Norway pays approximately one third of its electricity bill as fixed charges for network costs and the remaining two thirds for actual energy usage costs. Thus, the households have a volumetric tariff design and lack incentives regarding reduced capacity utilization. However, network capacity must be dimensioned to handle transmission of electricity during the peak load hours. Higher peak load implies higher investments for network strengthening, which should be reflected in the electricity bill of the consumer (Eriksen & Mook, 2020).

The rapid electrification of the transport sector has changed the consumption pattern as shown in Figure 8.8. If the average EV is charged during the afternoon peak, the national electricity consumption during that peak period increases to almost 18GWh/hr. Here it has been considered that the home charging is conducted at 7kW, which is the standard today.

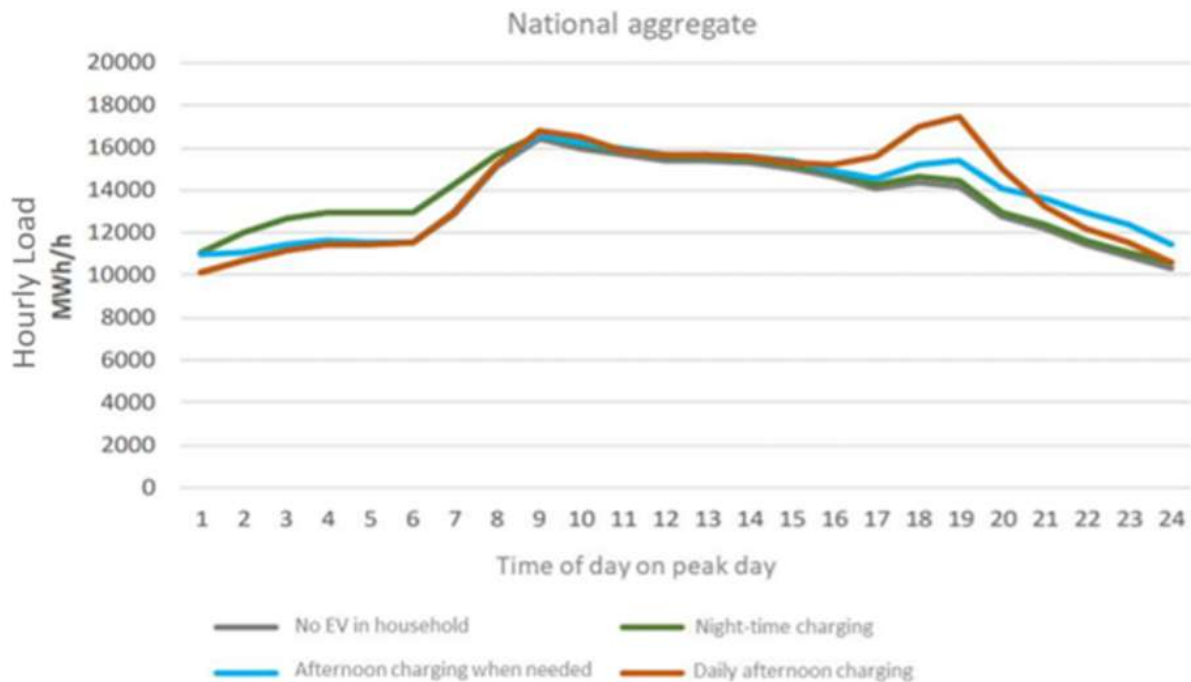

Figure 8.8: Changes in electricity consumption for different scenarios (Eriksen & Mook, 2020)

Three principles for tariff redesign have been proposed taking into consideration the change in consumption pattern.

1. *The energy charge shall be equal to the cost of marginal losses when there is excess capacity in the grid.*
For households, the average charge is INR 1.76 (EUR 0.02), while the cost of marginal losses in the network is approximately INR 0.44 (EUR 0.005¹⁵). This reduction will incentivize home charging in hours with available capacity.
2. *The price of utilizing the network should be higher than the cost of the marginal losses when capacity is constrained.*

¹⁵ Network losses are calculated with the function $f(x)=x^2$, where x is the amount of electricity transported through the network. Marginal losses = $2x$, and the cost of marginal losses is the losses multiplied by the market price of electricity.

When capacity is constrained, the marginal cost, does not reflect the cost of utilizing the network and so, the price of utilizing the network should be higher than the estimated cost of the marginal losses.

3. *Network tariff design should provide a reasonable distribution of fixed network costs, through a differentiation of fixed costs based on the customer's demand for capacity.*
As the energy charges are reduced, so additional fixed or capacity changes can be introduced to recover the income cap.

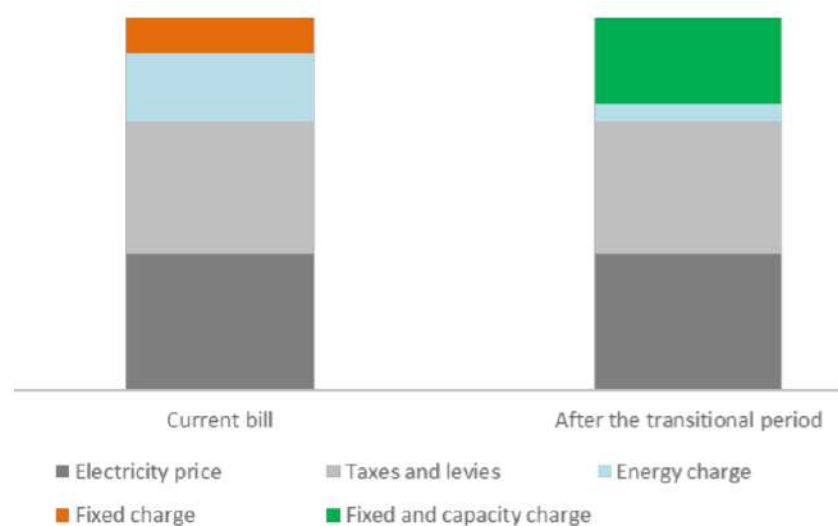

Figure 8.9: Current and proposed changes in structure of electricity bill (Eriksen & Mook, 2020)

Based on the above principles the following tariff designs have been proposed.

1. **Measured Capacity**

In this approach, the network costs are mainly differentiated based on customer's daily peak. The daily peak is priced through capacity charge, where the price each consumer pays is the sum of the daily peaks over the period in question.

2. **Subscribed capacity**

In this approach, the fixed charge is divided into several subscription levels. The subscription is decided based on the consumer's preference or through their historical consumption.

3. **Fuse size**

In the fuse size approach, the subscription level is determined by the customer's fuse size, including both physical and virtual fuse sizes in smart meters.

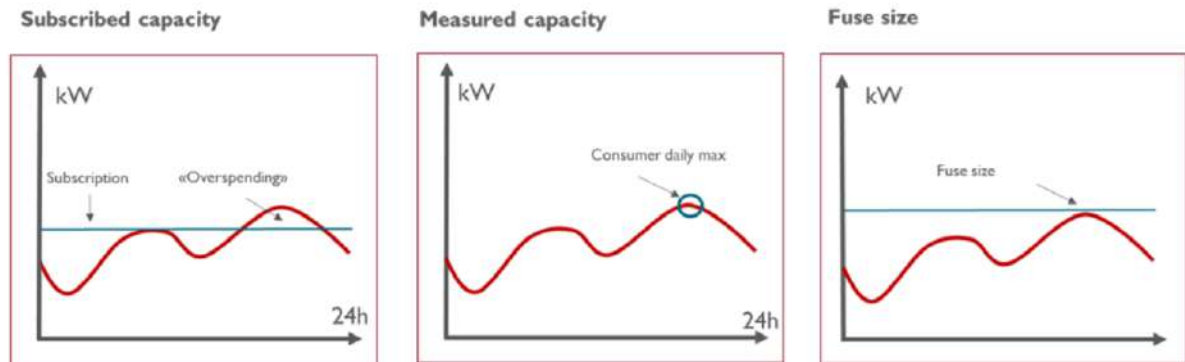

Figure 8.10: Three main models of tariff structure

8.6 Case Studies

8.6.1 INVADE

Project Category: Large scale European trial with pilots in 5 countries (Lloret & Olivella, 2018)

Project Aim: The primary goal of the Norwegian pilot in the INVADE project was to investigate the intersection between V2H/ loads/ PV, effect-based tariffs and energy management in private homes and buildings.

Project Duration: 2017-2020

Summary: For providing bidirectional charging in the INVADE project, Nissan Leaf was procured. The V2H support was integrated into the SMARTLY platform, which in itself is a company that provides solutions for energy management to housing companies and businesses.

INVADE is a multinational project that seeks to solve the issues of system resilience and flexibility due to increased penetration of renewable technologies, EV, and battery storage, using existing technologies. The Norwegian pilot focuses on end-customers, on how by controlling the loads, EV charging, V2H, the grid infrastructure investment may be avoided/postponed. The three services that are specified for the pilot are

- Optimized energy consumption based on hourly energy prizes i.e., low priority loads at peak hours will be disconnected
- Optimized energy consumption based on power-based tariffs.
- Optimized utilization of self-generated PV production.

Lyse, a power company in Norway plays the role of flexibility operator (FO) as shown in Figure 8.11. The sequence of operation for the pilot is given below, Figure 8.11

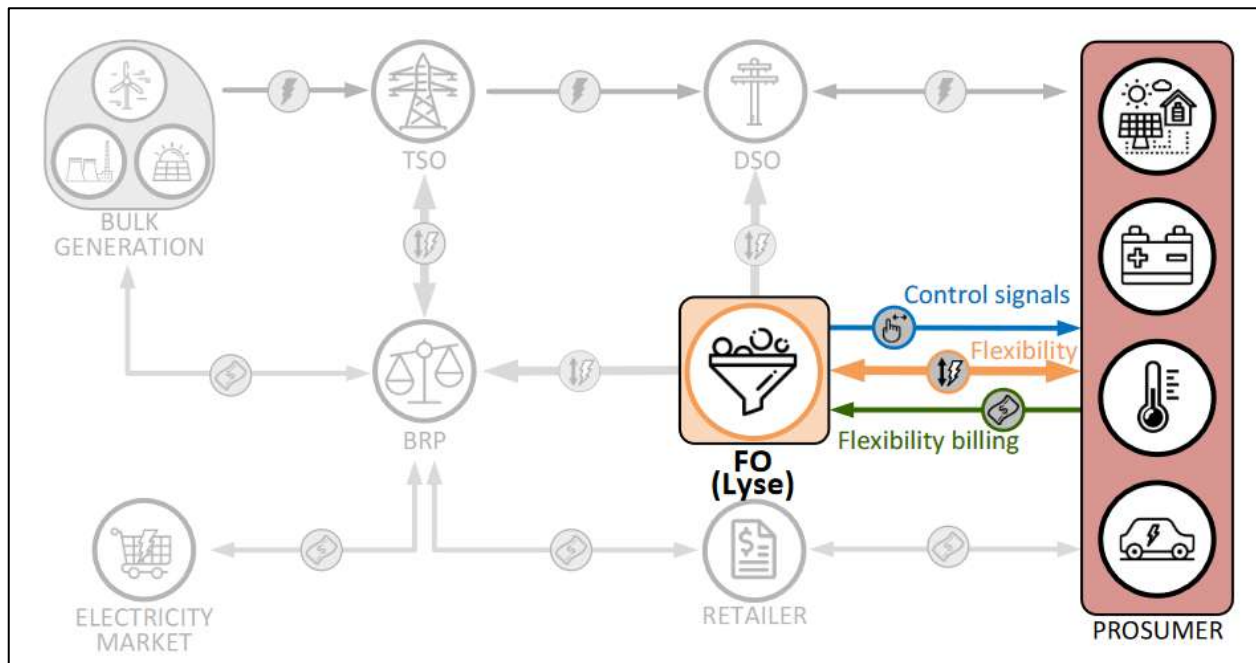

Figure 8.11: Interaction diagram of the Norwegian pilot (Lloret & Olivella, 2018)

- Depending on the energy consumption, status of flexible resources, and forecast, the INVADE platform creates the flexibility plan with the optimized consumption profile of all sources
- The FO sends the control signals to the Smartly hub, for the entire planning horizon prior to the actual delivery time.
- During the settlement process, the FO uses the metered values to calculate the flexibility activated by the FO in comparison to the forecasted baseline.

The final results of the pilot have not been published yet.

8.6.2 Electrical Infrastructure for Good transport (ELinGO)

Project Category: R&D Project

Project Duration: 2016-2018

Project Aim: The project explored various technological solution to electric roads and analyzed the economical, societal and climate impact associated with the realization of such solutions.

Project Summary: In order to realize Norway's ambitious targets of EV penetration, the government sought out new technological solutions to ease the range anxiety associated with EV use. One such solution is the electrification of the road network. However there are various technical solutions for the electrification of the road network as listed below (Langhelle et al., n.d.)

- Overhead lines over the roads
- Rail in the roadways
- Wireless transmission

The three different E-road technologies have been described below

Overhead lines

Overhead lines are one of the more developed technologies as this mode of electrification has been in use extensively for trains, trams etc. The benefit of this technology is that it can be easily installed as it is a well-known solution however, passenger cars and other light duty vehicles will not be able to utilize this technology.



Figure 8.12: Overhead lines in use for road electrification

Rail

Different variants of this technology have been in the pilot phase. This technology works by the conductive transmission of power from the roadways to the vehicles. The benefit of this technology is that it can serve vehicles of different sizes and different power requirements. But its drawbacks are the maintenance of the rails, ignoring the weather conditions like snow, rain, and the isolation of the rail if not in use, so that if walked over it does not electrocute any human/animal.



Figure 8.13: Electrified rails

Inductive

This is the newest technology for the electrification of highways and is currently being tested in various pilots, particularly in Sweden. However, costs of implementation of this technology are significantly higher as the inductive coils have to be placed under the road asphalt. But this technology nullifies the drawbacks of the other two technologies for road electrification.

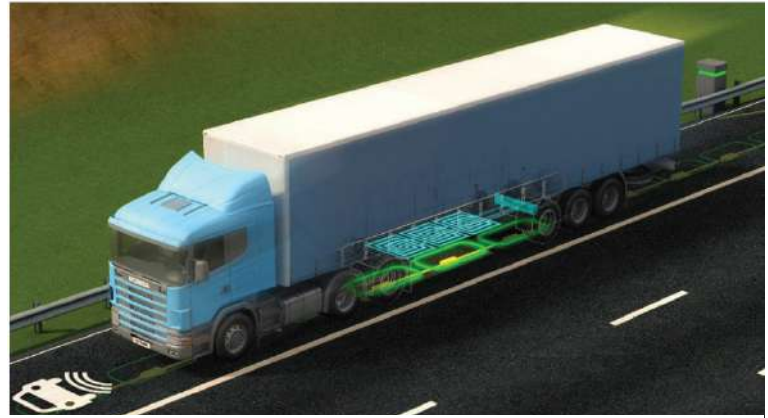

Figure 8.14: On road inductive charging

Figure 8.15: Route E39 from Trondheim to Kristiansand (Langhelle et al., n.d.)

Life Cycle Analysis

The life cycle analysis calculates the total emissions from all subprocesses in the value chain of the technology. To perform the life cycle analysis, it has been assumed that route E39 has been electrified using the technologies mentioned. The installation has been assumed to be done in 2020 due to which the carbon footprint of the technologies has been high for 2020. Furthermore, it has been assumed that 40,000 vehicles travel on E39 between Stavanger and Bergen and the yearly growth rate of vehicles has been set at 2% till 2050. It has also been assumed that after a period of 4.5 years from the installation date of the technologies the heavy vehicles would start being electric and being completely electric by 2030. As can be seen in Figure 8.16, the annual CO₂ emissions peak in 2020 due to the installation of the technologies but the total CO₂ emissions reduces for the road electrification technologies by 2027-28 when enough heavy vehicles have transitioned from diesel to EV as shown in Figure 8.17.

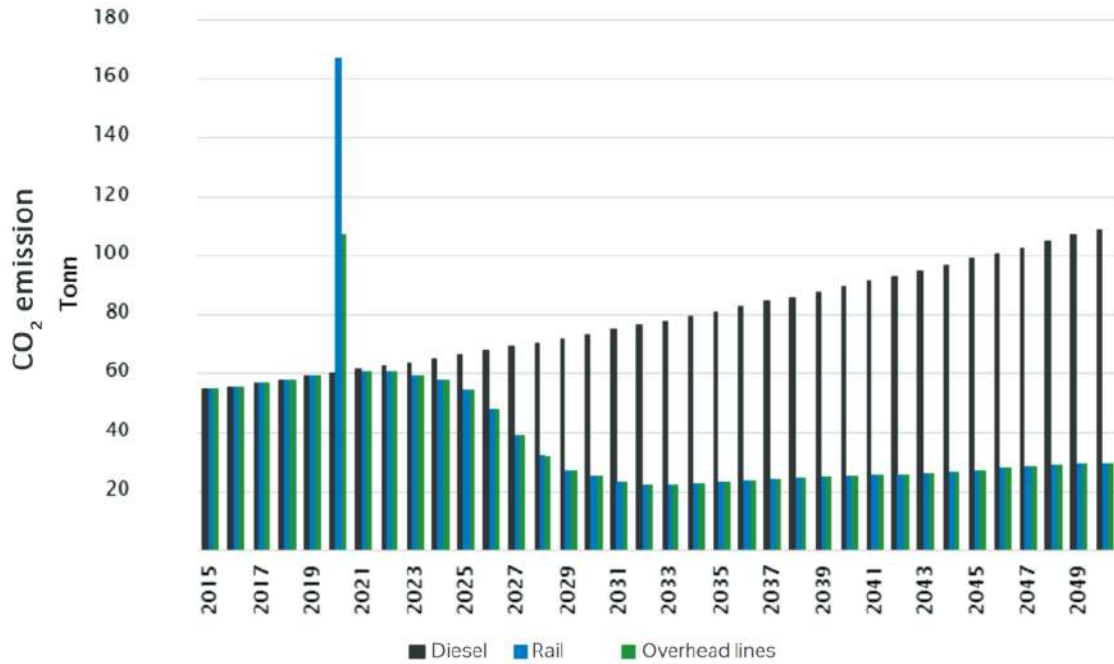

Figure 8.16: Annual CO₂ emissions with diesel and electric roads (Langhelle et al., n.d.)

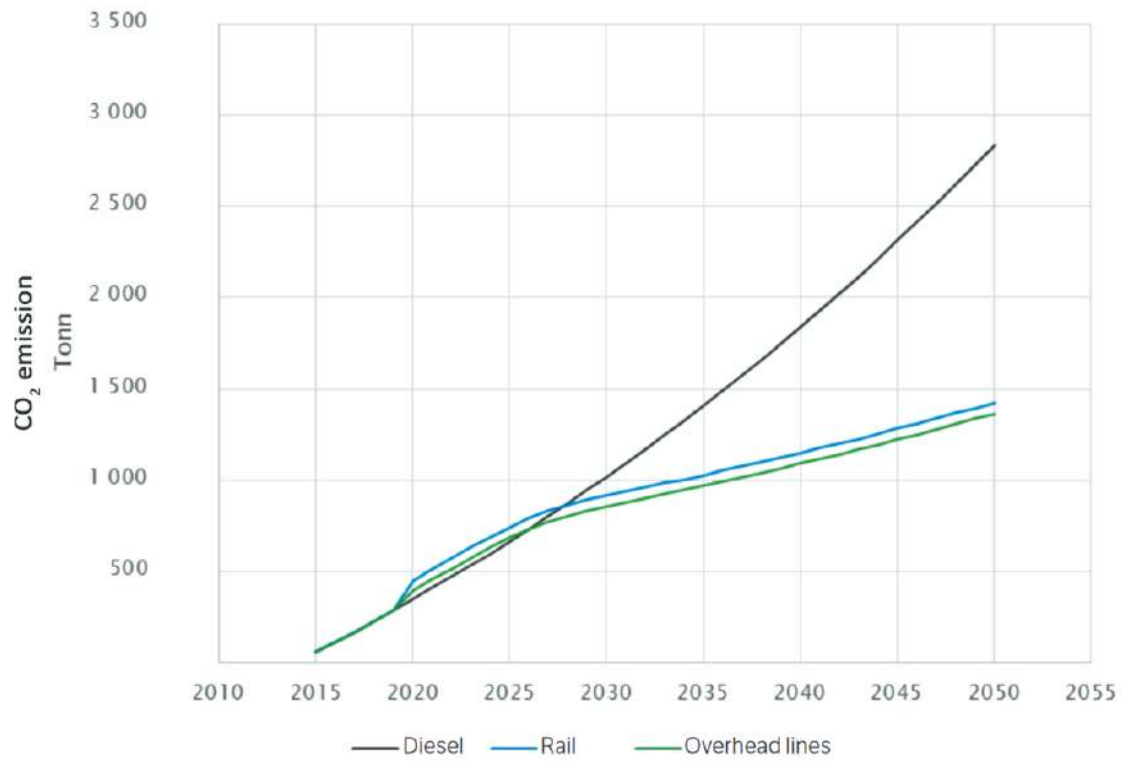

Figure 8.17: Cumulative CO₂ emission (Langhelle et al., n.d.)

Chapter 9. Sweden

9.1 Background for policy making environment

Sweden has been consistently ranked as one of the top ten best-selling plug-in markets, which can be attributed to the active support by the Government of the Kingdom of Sweden. The Swedish government approved an INR 1,73,08,56,600.00 (EUR 19.6 million) program to provide purchase subsidies of INR 3,46,171.32 (EUR 3930.19) per car to electric vehicles or ultra-low carbon emission vehicles, which are defined as vehicles with tail-pipe emission of less than 50g of CO₂ per km of travel in 2011. The government also excluded EV owners from the annual circulation tax for a period of up to five years from their date of purchase. In December 2014, the Swedish parliament approved another INR 1,86,06,70,845.00 (EUR 21.12 million) to further finance the subsidies till 2015. Recently, Sweden introduced a ‘bonus-malus’ system for private car owners, light buses and light lorries. Under this system, starting from 1st July 2018, owners of cars with CO₂ emission between 0 and 60g/km receive a rebate ‘bonus’, which can go up to INR 5,20,542.48 (EUR 5909.87). Vehicles emitting a large amount of CO₂ will be, however, burdened with higher vehicle tax ‘malus’. The CO₂ tax is added onto the base vehicle tax and amounts to INR 711.40 (EUR 8.076)/g of CO₂ if the vehicle emits more than 95g/km and up to 140g/km of CO₂ and INR 928.10 (EUR 10.537)/g if the vehicle emits more than 140g/km.

9.2 EV Charging infrastructure policies and regulations

Policies Enabling EV charging on supply-side		
Element	Policy Instrument	Measures
The incentive for launching the EV charging market		Subsidy for charging infrastructure for electric and hybrid cars (formerly "Klimatklivet") grants up to 50% investment from the government
	Charge the car grant	<ul style="list-style-type: none"> Covers the cost of up to 50% of the cost of EVSE materials, up to a maximum cost per charge point of INR 86,758.37 (EUR 985) INR 87,967 (EUR 1,000) for individuals INR 1,31,950 (EUR 1,500) for companies, municipalities, councils, and foundations.

	Swedish Transport Association Fast Charging Grant	<ul style="list-style-type: none"> Grant for up to 100% of the costs of fast charging public-use EVSE.
Prioritization in terms of EV characteristics and social geography	Stockholm	Free charging of EVs and PHEVs for users who subscribe to a parking space in Stockholm, only pay the parking fee.
Elimination of administrative barriers for establishing charging stations	Gothenburg Car Charging Permit	EV users can apply for a car charging permit for one of the city's many parking facilities by creating an account on the Gothenburg Parkering website, apply for a parking permit, and then a charging permit.
Policies Enabling EV charging on demand-side		
Element	Policy Instrument	Measures
Specification of the use of a wide range of payment methods	Uppsala charge point subscriptions	Subscription allows users to access to available charging points in the city with free parking.
Specification of minimum facilities to be provided at charging stations	Malmö charging point rentals	<p>Parking is free, and electricity costs INR 26.39/kWh (EUR 0.30/kWh).</p> <p>The local government is working to provide 20% of parking spaces with EVSE.</p>

Sweden being the forefront on climate action has been no different on the EV policy front. On the supply side, the government has several incentives, including grants to set up EV charge points, cost reduction on EV charging materials, special cost reductions for fast charging. On the consumer front and demand side, in the city of Stockholm, EV user can use charging for free if they already pay for the parking space. While the reverse is applicable in other cities, EV users can park for free and subscribe to charging. Overall, the country has many different approaches to the utilization of parking spaces and associated fees.

9.3 EV Charging infrastructure

Total public charging stations in the country is 11568 as of Feb, 2021. Home charging dominates other forms of charging. Most home charging takes place at the residence. Very few electric car owners charge their car at a publicly available street parking place near the house. Charging at

work is also relatively common: 35-40% of people surveyed claim to do so daily or weekly (*Nordic EV Outlook 2018*, 2018). In public charging stations, Type 2 connector type dominates with 82% of all charging outlets as shown in Figure 9.1. Among fast DC chargers, 4% of public charging points are a CHAdeMO charger and 5% are a CCS connector.

The evolution of the number of EVs per public charging point in Sweden has been shown in Figure 9.2. Compared to Norway, Sweden has a better ratio of EVs per charging point, which implies a better investment on public charging infrastructure. Even then, more public charging stations are required to cater to the rising EV market as well as bring the ratio to below 10 EVs per public charging point as targeted by the EU.

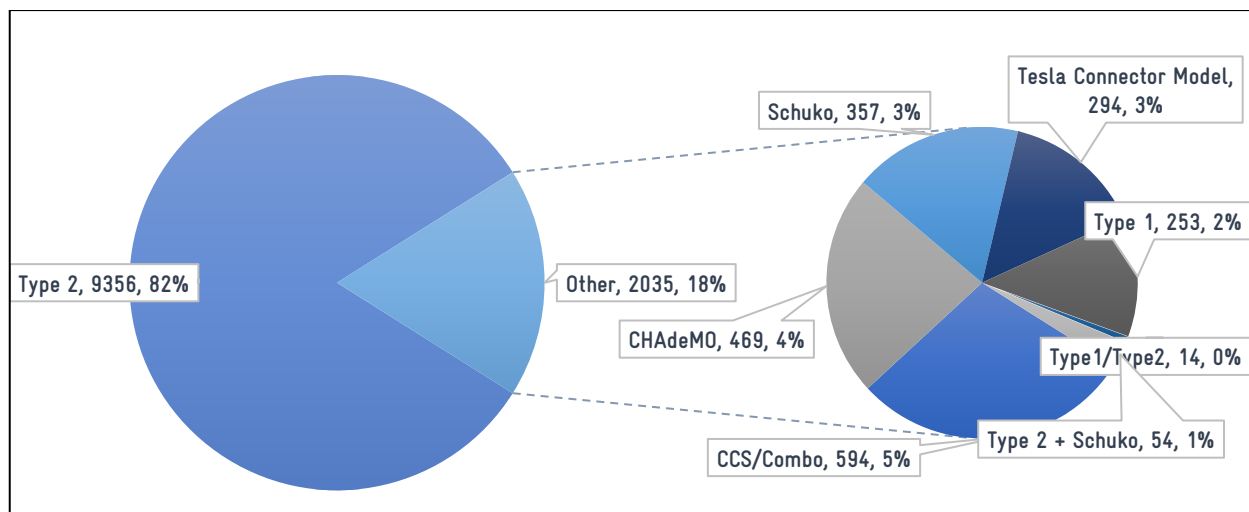

Figure 9.1: Details of Public Charging Stations in Sweden (Statistics 2021)

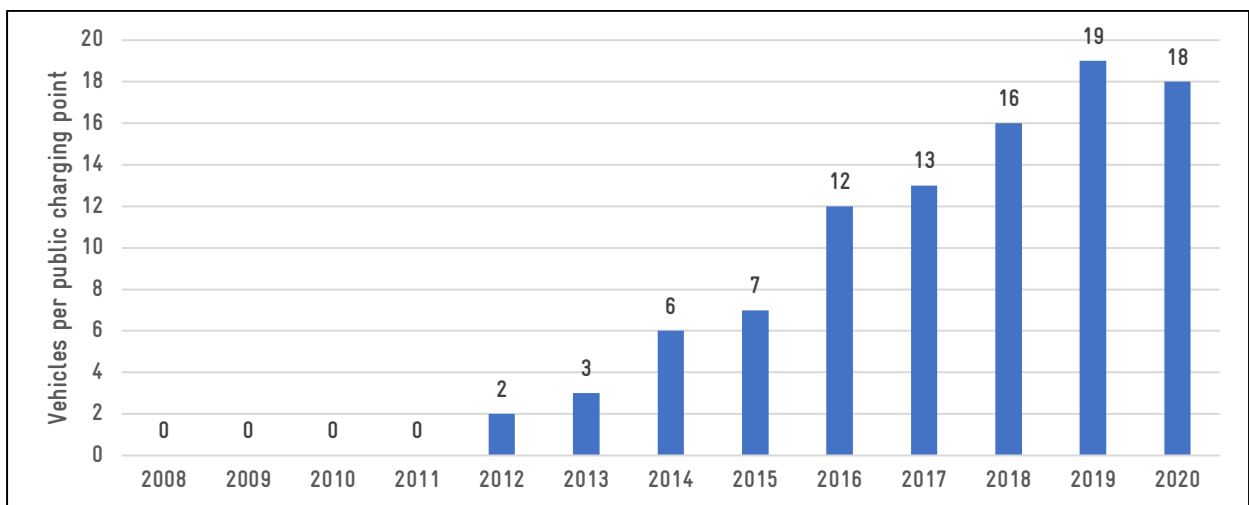

Figure 9.2: Number of EVs per public charging point in Sweden (*Sweden*, 2021)

9.4 EV demand status

By the end of 2019, there were 48,87,904 vehicles registered in Sweden. Of the total vehicle stock, 30,343 are BEVs which is around 0.6% of the total vehicle stock; 66,609 are PHEVs which account for 1.4% of total vehicle stock. In case of light trucks, 3,946 light trucks are battery-powered, 4 light trucks are a PHEV which corresponds to 0.64% of total light truck stock. 268 buses are BEV and 152 are a PHEV, corresponding to 1.8% and 1.0% of total bus stock, respectively. As can be seen in Figure 9.3, the number of hybrid vehicles in Sweden is much higher than the number of battery electric vehicles. Figure 9.4 and Figure 9.5 show the total registered EVs and HEVs in Sweden based on vehicle model and manufacturer. Nissan Leaf is the highest selling EV in Sweden, with a total of 8403 number of Nissan Leaf's, while Volkswagen Passat is the most popular HEV. Comparing Fig. 12 and Fig. 13 it can be seen that Kia Niro which is the 6th most popular HEV in Sweden has higher stock than Nissan Leaf, the highest selling BEV.

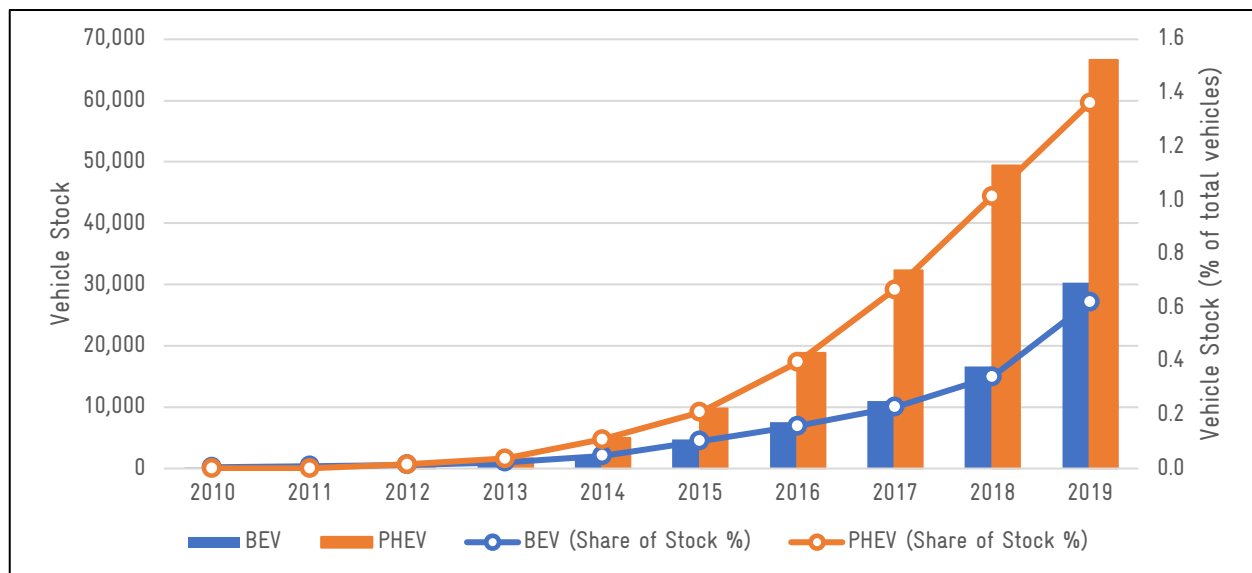

Figure 9.3: Passenger vehicles by fuel type (*Vehicle Statistics, 2020*)

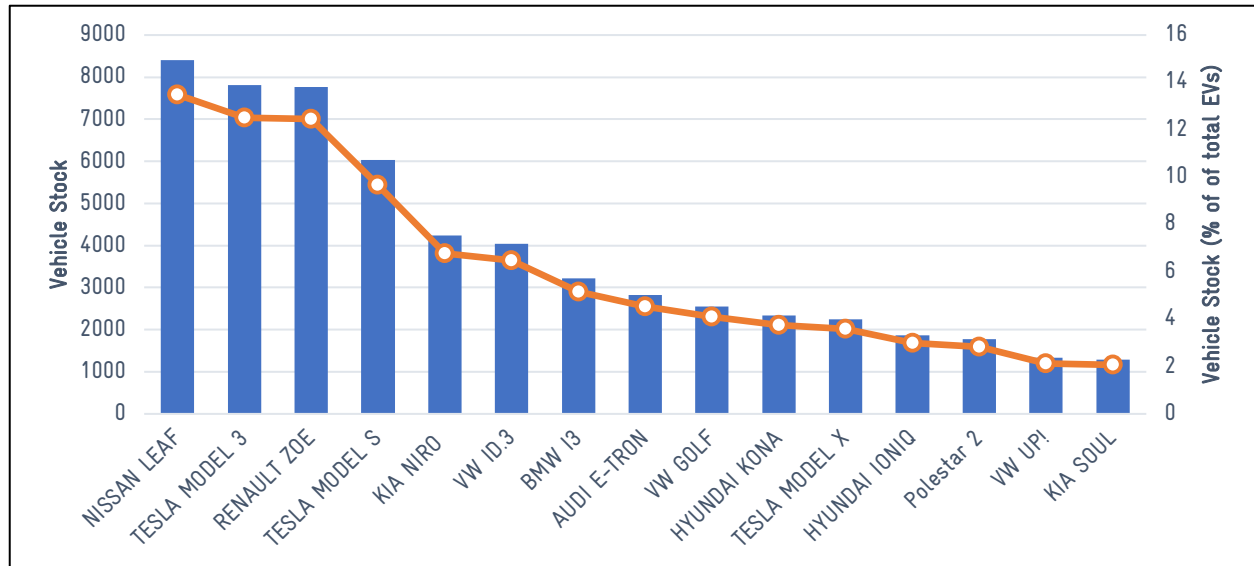

Figure 9.4: BEV sales up to 2021 (Nyregistreringar, 2021)

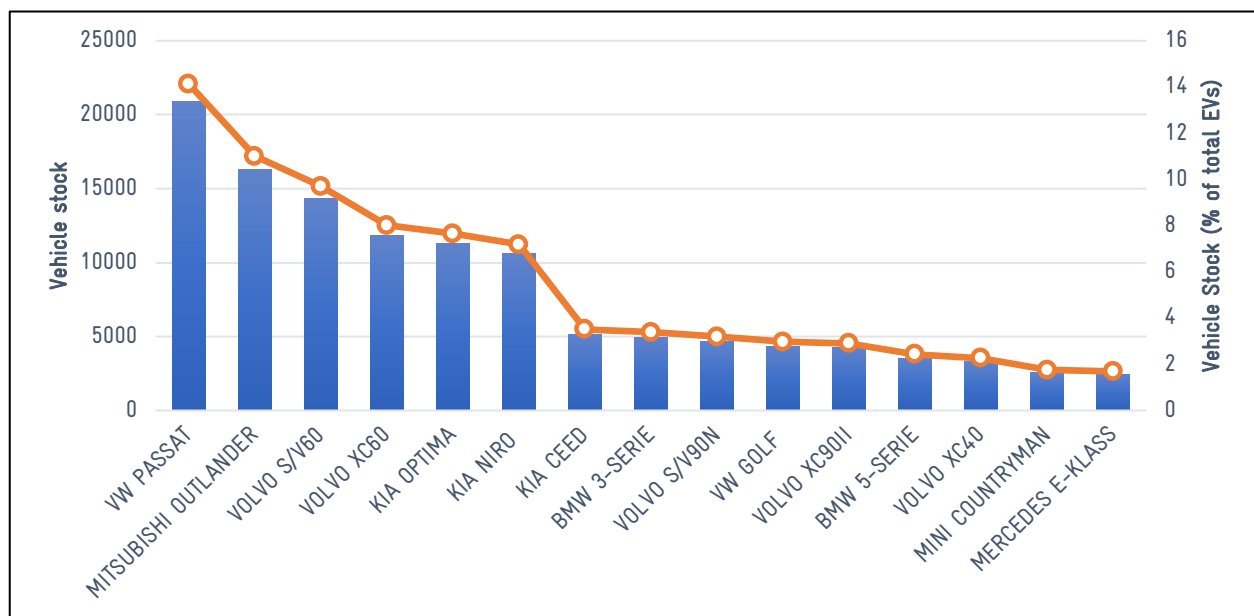

Figure 9.5: PHEV sales up to 2021 (Nyregistreringar, 2021)

9.5 EV integration

To study the impact of high EV penetration on the distribution network, the state-owned research company Energiforsk conducted a simulation study considering different end user scenarios (Sandels & Widén, 2018). Customer and grid data from a rural and an urban low voltage grid in Herrljunga Elektriska’s distribution grid have been used as input for the simulation studies.

The definitions of the different scenarios have been given in Table 9.1.

Table 9.1: Scenario Summary

Scenarios	Rural grid	Urban Grid
Base Case (BC)	18 customers, 8 heat pumps (HP), 0 PVs and 0 EVs	97 customers, 59 HP, 0 PVs and 0 EVs
Energy Efficiency (Eff)	8 HP but better efficiency than BC	59 HP but better efficiency than BC
Electrification (Elec)	18 HP, 18 EV with 3kW chargers	97 HP, 97 EV with 3kW chargers
Small Scale Production (PV)	8 HP, 18 PV of 5 kW	59 HP, 97 PV of 5kW
Flexibility (Flex)	8 HP, space heating and domestic hot water (DHW) flexibility of 1°C and 5 °C	59 HP, space heating and domestic hot water (DHW) flexibility of 1°C and 5 °C
Small scale PV + Electrification (PV+Elec)	18 HP, 18 EV with 3kW charger, 18 PV with 5kW	59 HP, 59 EV with 59kW charger, 18 PV with 5kW
Small scale PV+electrification + digitilization and flexibility (PV+Elec+Flex)	Same as above but with space heating and DHW flexibility and EV charging flexibility with min SOC of 85%	Same as above but with space heating and DHW flexibility and EV charging flexibility with min SOC of 85%
Small scale PV + energy efficiency (PV + Eff)	8 HP but better efficiency than BC, 18 PV with 5kW	59 HP but better efficiency than BC, 59 PV with 5kW

Figure 9.6 shows that the system load is dependent on the ambient temperature with colder days showing higher loads. The voltage variation also shows a linear correlation with the ambient temperature. This can be explained by the increase in load demand for space heating purposes during the colder days leading to voltage degradation in the weak bus.

The results of the various scenarios for the rural grid are given in Figure 9.7. The daily load factor decreased for all scenarios except for electrification which is due to the high EV charging load during the off-peak night hours. Undervoltage issues are also seen for electrification scenarios with the Electrification+PV+Flexibility scenario showing the worst performance, although no overloading issues were observed for the rural distribution network.

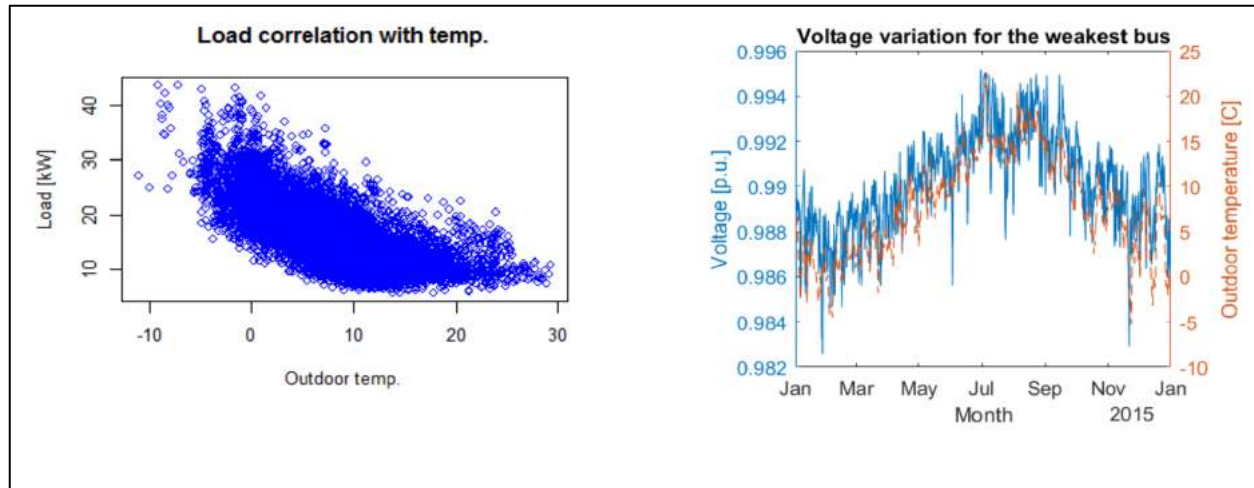

Figure 9.6: Load and voltage variations (Sandels & Widén, 2018)

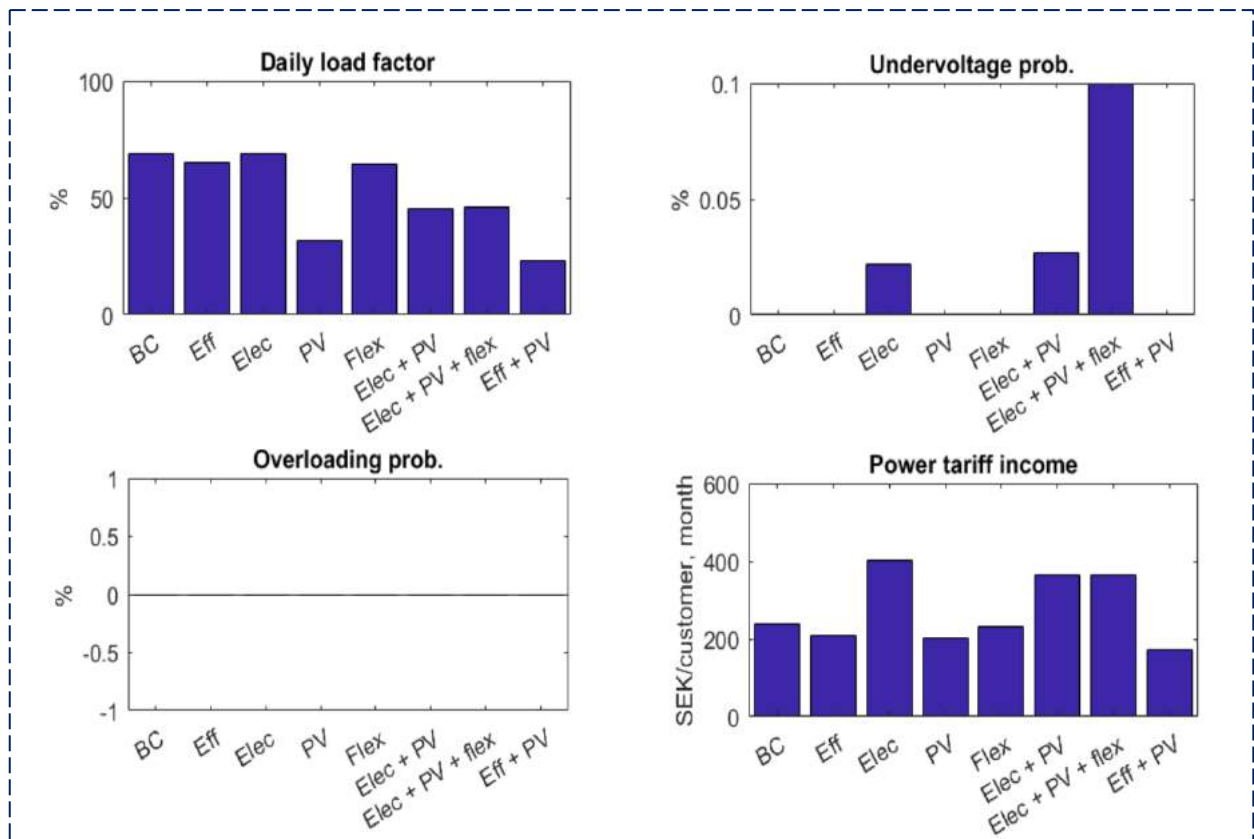

Figure 9.7: Result of different scenarios for the rural grid (Sandels & Widén, 2018)

In Figure 9.8, the difference between urban and rural results for all the scenarios has been shown. As seen the daily load factor is better in the urban grid than the rural grid. The undervoltage issues

are also more severe for the rural grid which is due to the stronger urban grid. The power tariff is also higher for the urban grid except in the Elec+PV scenario.

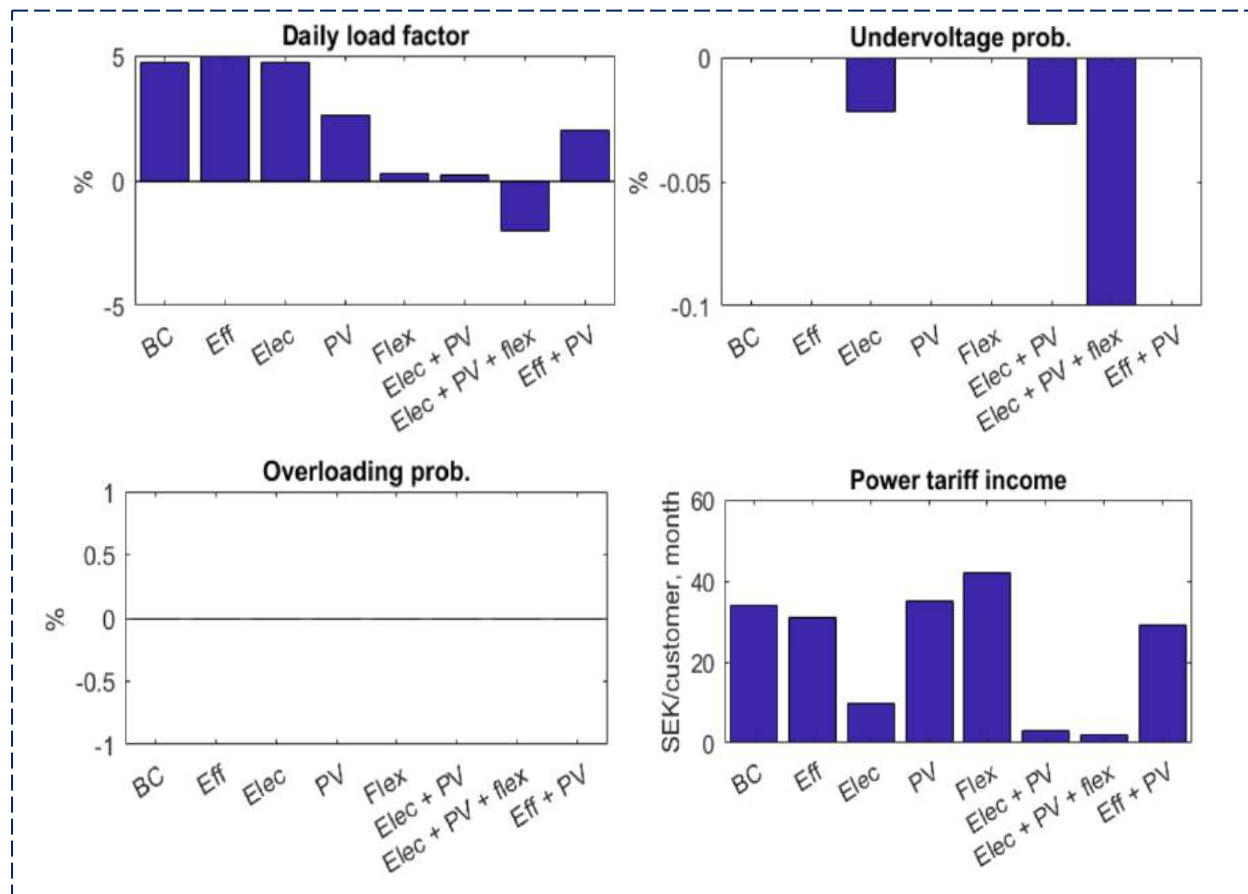

Figure 9.8: Difference between urban and rural results for all the scenarios

Sweden implemented the world's first wireless electric road charging, Smartroad Gotland which is a 1.6km stretch of road (*Smartroad Gotland*, n.d.). The infrastructure lies passive under the road until a vehicle passes over a coil, and the vehicle is certified as a certified receiver of energy. It comprises of the following (*Electreon*, n.d.)

- Under-Road Units which are the copper coils under the asphalt
- Management Unit that transfers the energy from the grid to the road infrastructure and also manages communication with the approaching vehicles
- Vehicle Unit, which are receivers installed on the floor of the vehicle to transmit the energy to the engine/battery

- Central Control Unit, which is cloud based and communicates with all management units and registered vehicles.



Figure 9.9: Installation of coils for wireless energy transfer in the Smartroad Gotland pilot (*Smartroad Gotland*, n.d.)

Its advantages lie in:

- Minimization of battery size
- Increase utilization
- Elimination of range anxiety
- No requirement of charging stations

9.6 Case Studies

9.6.1 eRoadArlanda

Project Category: Demonstration Project

Project Aim: Electrification of road network for conductive charging of electric vehicles

Project Duration: 2011- to date

Summary: A part of the Swedish Transport Administration's pre-commercial procurement of innovation, the eRoadArlanda is the first electrified road in Sweden, located on a ten-kilometre section of Road 893 between Arlanda Cargo Terminal and the Resenberg logistics area, of which two kilometres has been electrified so far. The charging of EV here is based on conductive

charging, using rails installed on the roads. The energy is transferred from the rail to the EV using a movable arm on the EV. The location of the rail is detected by the arm as long as the EV is directly over the rail and the contact is lowered. During overtaking, the contact is raised automatically. The rail is also divided into sections so that each section can be switched on/off individually. When the vehicle stops, the current through that section of the rail is disconnected automatically. The schematic for the EV charging is given in Figure 9.10. The project further proposed that in a road network, instead of electrifying the entire network, the major and the frequently visited roads would be electrified, and in the minor roads, the EV battery would power the vehicle, as shown in Figure 9.11.

Learnings:

- It would cost INR 69,462 crore (EUR 7.8 billion) for the electrification of 20,000 km of roads in Sweden. While current vehicle fuel costs amount to INR 36,478 crore (EUR 4.14 billion) per year and clean electric power would cost about INR 8,687 crore (EUR 0.986 billion) per year, the annual savings would be INR 27,788 (EUR 3.15 billion). Considering smaller battery EVs to cost the same as ICE vehicles, the electrification project would take less than 3 years for a complete return of investment.
- The project has also produced patented solutions on technologies to withstand extreme weather conditions such as snow or heavy rain.

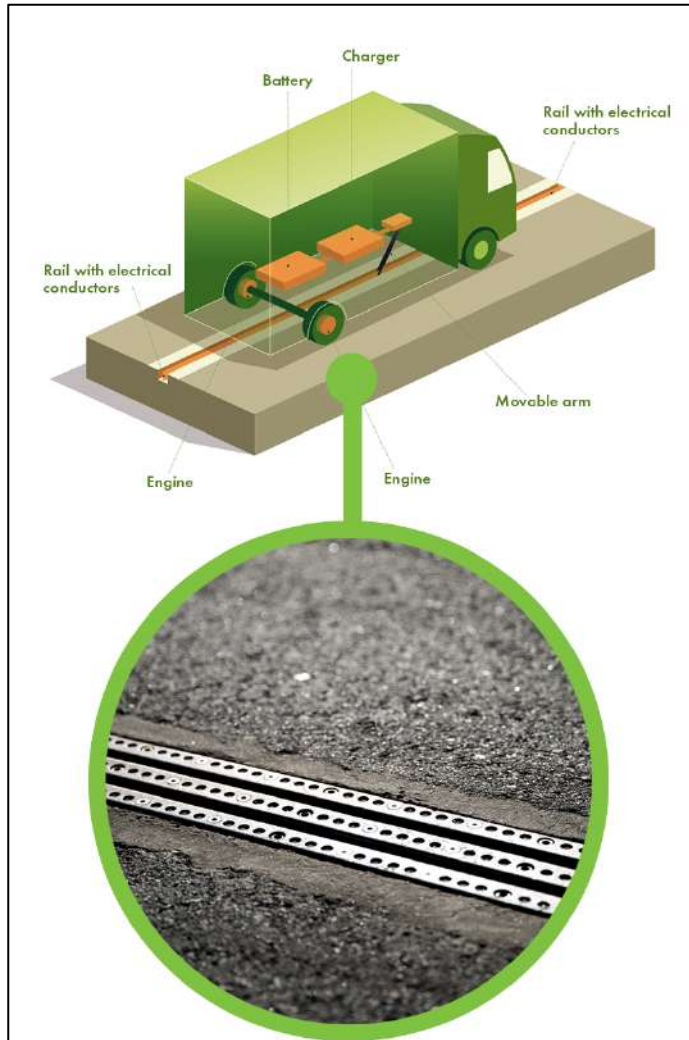

Figure 9.10: A schematic of EV charging in eRoadArlanda project (About the project n.d.)

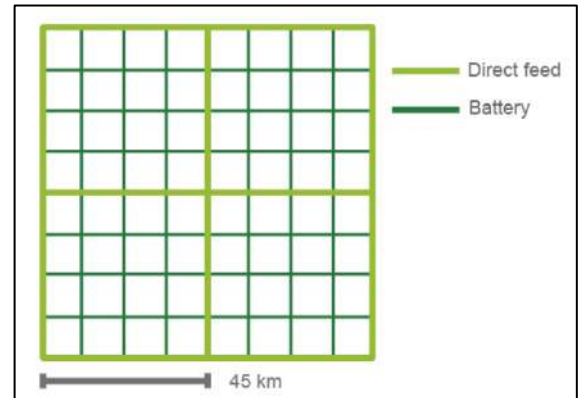

Figure 9.11: Proposed requirement of electrified roads in a road network (ERoadArlanda, n.d.)

9.6.2 Dynamic Wireless Power Transfer Charging Infrastructure for Future EVs: From Experimental Track to Real Circulated Roads Demonstrations

Objectives of the study:

1. Equipment prototype and its instrument description
2. Provide characterization result of the system
3. Analyze technical and economic challenges in inductive WPT and its future
4. Analyze inductive WPT technology as a part of future EV charging infrastructure.

Introduction:

There is a gap between user experience with conventional IC engine vehicles and EVs due to charging time, charging performance, cable handling, etc., and limiting the use of EVs (Stéphane Laporte et al., 2019). Wireless charging offers an alternative to exploring due to recent technology developments .

Electric Road Systems (ERS) with dynamic charging technology can transfer power directly and efficiently to a moving vehicle on the road, saving battery size. The charging technologies like overhead conductive charging and ground conductive charging are not robust or incorporable yet due to viability, infrastructure costs, etc. Wireless charging mitigates the electricity transmission hazards to other objects. The study focuses on resonant inductive wireless power transfer (IPT) for EV charging.

Fundamental Research Background and State of the Art of IPT Applications to Non-Guided Surface Transport

Inductive power transfer has two critical parameters:

1. Power transfer capability improvement with an increase in frequency
2. Effectiveness improvement using capacitors to create a resonant system.

The development of power electronic devices and improved performance at higher frequencies raised interest among researchers in IPT technology. Many projects have demonstrated IPT technology over time for various vehicle types and power ratings with static and dynamic driving conditions. The FABRIC European project assessed the different charging technologies' viability for making way for potential future developments and EV range extension. In the project, the fixed part is integrated with the road environment, and the mobile component is integrated with the vehicle enabling the IPT system.

The opted operating frequency was 85 kHz for the charging system with EMF/EMI standards for charging power up to 20 kW on a 100 m test track. This technology is designed to charge the EV from stationary to a speed of up to 100 km/h on the highway.

The report provides the road infrastructure, equipment integrated into the vehicle, methods, prototype performance, safety assessment, result analysis, gaps to be bridged.

Road Infrastructure:

The power transfer has to be tested over varying speeds and different power levels up to 20 kW. Thus, the test track of 100 m is created with the charging point cabinets were constructed of dimensions ($l \cdot w \cdot d$) 80 cm * 180 cm * 20 cm. The cavity is designed to be accessible quickly and coils close to the surface. The measurements of car position, EMF is taken close to the track for data logging. The covers are made of reinforced glass fibre (3 cm thick) to meet the design constraints.

Electric Infrastructure Integrated with the Dynamic IPT System and Additional Equipment:

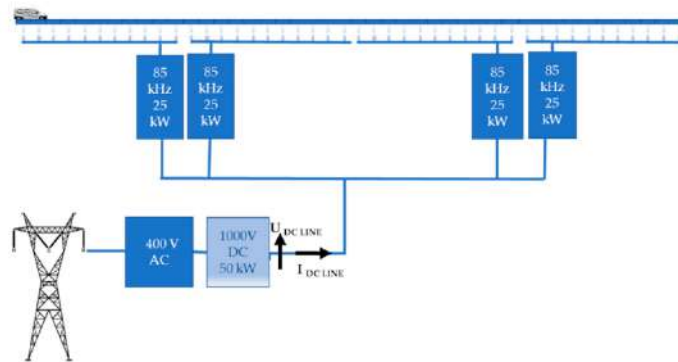

Figure 9.12: Functional schematic of EV charging infrastructure (Stéphane Laporte et al., 2019)

The charging system is supplied with 1000 V, 50 kW DC from 400 V AC supply along the test lane. The transformer, AC/DC converter, and measurement system are enclosed in a transformation cabinet close to the experimental test track.

Serial Vehicle Implemented with Dynamic IPT System and Additional Equipment:

Two extended Kangoos with the secondary coil in the vehicle provide the power to the Qualcomm power converter and battery pack. VEDECOM provides battery charging current and voltage data, misalignment measurement by GPS with navigation sensors, air gap measurement (centimetre-level accuracy) by laser sensors. The car CAN data is recorded with 100 kHz adjustable acquisition frequency via a multichannel data logger.

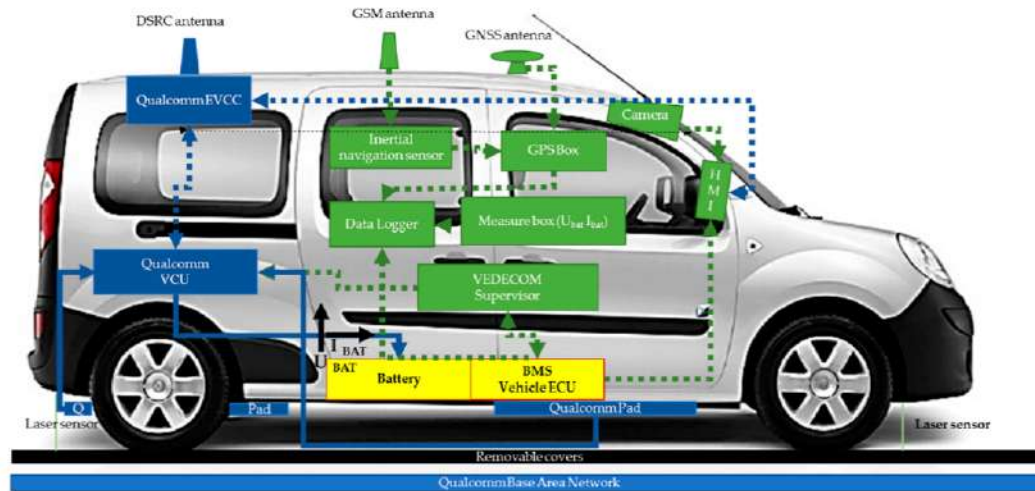

Figure 9.13: WPT components (blue), additional components (green), original (yellow) (Stéphane Laporte et al., 2019)

Direct short-range communication (DSRC) antenna exchanges the charging information with EVSE. The car is equipped with Human Machine Interface (HMI) to display all real-time info. Vehicle verifications with External Power Source are conducted to verify withstanding capability against brutal power variations.

Validation of the Integrated Vehicle and Infrastructure Methodology:

The vehicle battery voltage and current data are recorded (1 kHz sampling frequency), power delivered to the battery is determined, and the efficiency of the overall system is calculated. From the computed data and measured misalignment, it is observed that misalignment impacts the charging system's efficiency. The driving speed and the air gap also influence the efficiency significantly.

Electromagnetic field (EMF) exposure assessment is done inside and outside the vehicle with a wide frequency exposure level tester (1 kHz- 400 kHz) at various measurement points.

Additional System Characterizations Methodologies:

Electromagnetic radiated emissions were tested at 10 m away from the road for 10 kHz to 30 MHz with a magnetic antenna at maximum charging power and analysed. The impact of a dynamic air gap variation on charge performance evaluation methodology is analysed from the measured data.

Public Demonstrations, Validation Result, and Discussions:

According to FABRIC study cases, the demonstrations were done with two prototype cars at various power levels up to 20 kW and speed variations. The battery voltage and current show the pulsated shape for on-road charging and impact the system's efficiency. As regenerative charging improves battery life and battery discharge is not much, WPT charging could mitigate the depth of discharge of the battery and positively impact battery health. The grid to battery efficiency was observed to be around 70 % and can be improved significantly.

The electromagnetic field exposure values were in standard limits, with an average value of around 4 μT and max being 8.5 μT at the front passenger's feet. The radiated emissions were out of the limits specified by EN 50121 standard for frequencies between 150 kHz and 30MHz and confined better to reduce side emissions.

Conclusions:

From the demonstration, system efficiency is addressed, battery current and voltage shapes are analysed, the impact of misalignment and airgap on efficiency is studied, EMF exposure values are analysed. The future Wireless EV charging infrastructure could include bidirectional energy transfer based on WPT.

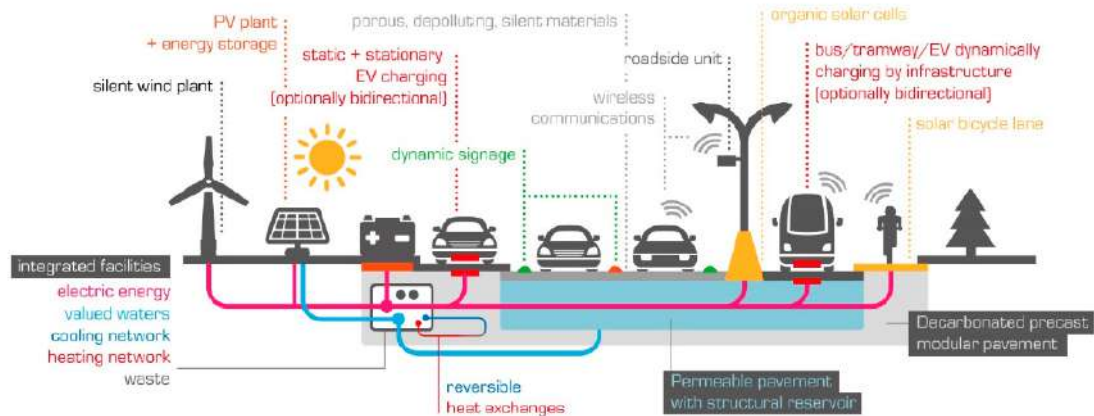

Figure 9.14: Dynamic Bidirectional WPT in a future road infrastructure ecosystem (Stéphane Laporte et al., 2019)

Chapter 10. The Republic of China

10.1 Background for policy making environment

EV charging policy in China has been addressed at both national and provincial levels. The central government has promoted the development of EV charging infrastructure by setting targets, mandating standards, and providing funding through various national policy instruments.

10.2 EV Charging infrastructure policies and regulations

Policies Enabling EV charging on supply-side		
Element	Policy Instrument	Measures
Definition of a fundamental market design framework to limit distortions and entry barriers	Guidance on Accelerating the Construction of EV Charging Infrastructure	<ul style="list-style-type: none"> • Sets target to provide more than 4.8 million decentralized charging stations to meet the expected 5 million EVs by 2020. (Hove & Sandalow, 2019) • Promotes government and social capital cooperation (PPP) models for EV charging infrastructure development. • Local authorities encourage to formulate relevant support policies that are publicly available to society and provide market expectations of policy stability
	Five-Year Plan for New EV Infrastructure Incentive Policies	All provinces mandated to increase support for charging infrastructure development and to establish a reporting system for EV charging infrastructure construction with monthly reports on the number of charging facilities

The incentive for launching the EV charging market	Regional policies	<ul style="list-style-type: none"> • In addition to the national policy measures, over 30 cities in the country offer some financial incentives for private or public EV charging infrastructure. • In Beijing, all new residential developments are mandated to reserve space for EV charging stations while new buildings owned by the government or state-owned enterprises must equip 25% of parking spots with EV chargers. • Shenzhen offers EV users subsidies for installation of EV charging stations while Guangzhou requires all new buildings to either reserve or equip 18% of parking space with EV charging stations (Hove & Sandalow, 2019).
Prioritization in terms of EV characteristics and social geography	Guidance on Accelerating the Construction of EV Charging Infrastructure	<ul style="list-style-type: none"> • Mandates equipping all new residential construction with EV charging. • Mandates installation of EV charging stations in public buildings with a specific mention of parking lots, large malls and stores • Prioritizes construction of urban public EV charging infrastructure as well as the construction of an inter-city fast charging network.
	Notice on Accelerating Residential EV Charging Infrastructure Construction	Sets standards and procedures for residential charging and designates the Jing-Jin-Ji, Yangtze River Delta and Pearl River Delta regions as demonstration zones for the residential charging infrastructure development
Policies Enabling EV charging on demand-side		
Element	Policy Instrument	Measures
Technical standardization of chargers for interoperability	National standards for EV charging interfaces and communications protocols.	The General Administration of Quality Supervision, Inspection and Quarantine, the National Bureau of Standards, the National Energy Administration, the Ministry of Industry and Information Technology, and the Ministry of Science and Technology issued five revised national standards including the charging interface and communication protocol for EVs

The mandate for the development of digital platforms and database management systems	Guidelines for Developing EV Charging Infrastructure	<ul style="list-style-type: none"> • Encourages the provision of intelligent charging such as charging navigation, status inquiry, charging appointments, and bill settlement. • Establishment of a national EV charging infrastructure promotion alliance to facilitate interconnection and conduct inter-operability testing and certification of charging facilities.
Harmonization of cross-border/cross-provider user registration for accessing charging infrastructure	Guidelines for Developing EV Charging Infrastructure	Establishment of a national EV charging infrastructure promotion alliance to facilitate interconnection and conduct inter-operability testing and certification of charging facilities.
The incentive for launching the EV battery swapping market	Guidelines for Developing EV Battery Swapping Infrastructure	<ul style="list-style-type: none"> • Safety Requirements for EV Battery Swapping gives the first set of requirements for EV battery swapping mode requirements by the Electric Vehicle Sub-committee of the Automobile Standards Committee.

The Chinese government has been aggressive in rolling out EV infrastructure by establishing clear roadmap. The government is roping in local authorities and is mandating all provinces to increase their EV charging infrastructure support via the five-year plans. Besides public sector push, there is also encouragement for public-private partnerships initiatives. On the supply side, in addition to the national policy measures, over 30 cities in the country offer some financial incentives for private or public EV charging infrastructure. In Beijing, all new residential developments are mandated to reserve space for deployment of EV charging stations while new buildings owned by the government or state-owned enterprises must equip 25% of parking spots with EV chargers. Shenzhen offers EV users subsidies for installation of EV charging stations while Guangzhou requires all new buildings must either reserve or equip 18% of parking space with EV charging stations (Hove & Sandalow, 2019). On the demand side, the government has issued revised standards that lay out details from connection type to communication protocols. Interoperability and harmonization of charging infrastructure across is facilitated via alliances, including establishment of database management system to indicate charge point availability,

payments etc. The government also has a specific policy in place for battery swapping safety protocols.

In May 2021, it was noted that the registrations for plug-in EVs in China have increased by about 146% over the same period last year, with a total of 190,000 registrations which accounts for 12% of the overall car sales (Mark Kane, 2021). The figure stands as proof now that the proportion of EVs compared to other cars will permanently remain over 10%, with the March and April numbers being 11% and 10%, respectively. Among the plug-in EVs, all-electric battery-EVs remain in the majority with a 9.4% share and expand at over 153% over the same period year-on-year.

In terms of the models that are seeing rapid sales, the Wuling Hongguang Mini EV is the runaway winner in terms of volume of sales, with the Tesla Model Y being in second place, followed by the Model 3 under the same brand. The fourth and fifth places are occupied by the Changan Benni EV and the BYD Han (EV), both coming from Chinese manufacturers.

In China, the city of Lizhou has been setting an example in terms of the promotion of EVs, with almost 30% of cars being sold in 2020 being electric, which is five times the country average. This makes the city with a population of 4 million effectively the biggest EV market in the world (Bloomberg, 2021). This rapid growth came as a result of the thrust from the city authorities to make Lizhou a manufacturing hub for EVs and long-running programs by the manufacturer for the public to address their concerns over range, reliability and battery safety. SAIC-GM-Wuling Automobile Co., one of the leading makers for cheap EVs in China and a joint venture between US giant General Motors and state-backed SAIC Motor Corp. and Guangxi Automobile Group Co., is headquartered in the city. The company had been giving out a series of incentives, ranging from extensive test drives to free parking and ample charging points, to change people's perception in favour of EVs. This certainly sets an example for the billion-dollar valued car makers worldwide who are betting high on an electric future and governments who have been providing financial incentives but have seen only a gradual rise in the sale of EVs. With the target of meeting the needs and driving habits of the residents, SAIC-GM-Wuling had brought out the small-sized two-seater model, Baojun E100 and have upgraded it further to tailor as per the city's requirements. Thereby, it has seen a massive surge in sales eclipsing Tesla Model X as the top seller in the country by a mile.

Further drivers are also being rewarded with cash prizes for achieving particular annual mileage, which has furthered sparked people's interest in EVs. The city has invested massively in creating a widespread network of charging points (around 30,000) and parking spots (15,000). One of the

key points that set the transition apart from the ones in the west was the motivation to strengthen the local automobile industry, the leading industry in the region. With China already prioritising the nationwide expansion of EVs on a war footing, the government of Lizhou found it very suitable to make the best use of funding opportunities for its auto industry and steam ahead in the EV market. It certainly puts up a great example that other nations can take ample inspiration from and can take away a few learnings from it as a whole.

10.3 EV Charging infrastructure

Structural reforms on the energy supply side and emission reduction continue to play a key role in the rapid growth of EV charging infrastructure in China. China has approximately 807,000 public charging points that are operational across the country, among which 498,000 are AC chargers, 309,000 are DC chargers, while 481 come equipped with both AC and DC capabilities ¹⁶

Table 10.1: EV charging in China¹⁷

	Year	
Total Public + fleet charging points	2018	330,000
	2017	210,000
Annual growth rate of public + fleet charging points	2017-2018	43%
Number of charging stations	2018	70,000
	2017	50,000
DC fast charging market share	2018	36%
	2017	24%

The growth of public EV charging points in China have been given in Figure 10.1.

¹⁶ China Electric Charging Infrastructure Promotion, 2020

¹⁷ Source: China EV Charging Infrastructure Promotion Alliance

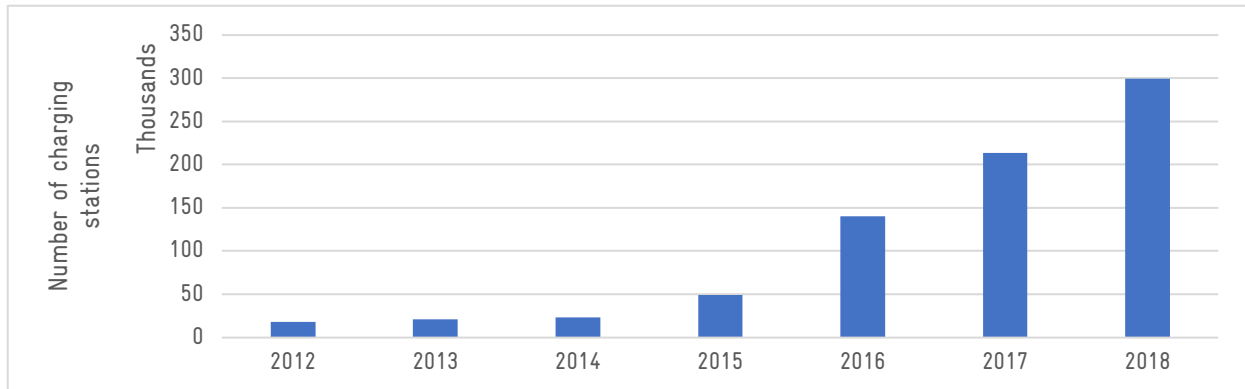

Figure 10.1: Growth of public charging points in China(Hove & Sandalow, 2019)

In China, the top tier cities have taken a lead in installation of public charger installations. At the end of 2018, Beijing, Shanghai, and Guangdong Province accounted for just under 40% of charging posts nationwide.

The annual installation of charge points have been shown in Figure 10.2. It shows that there has been a major push towards widespread deployment of EV chargers in 2019 and 2020, with approximately 115,000 chargers deployed in December 2020 itself as shown in Figure 10.3

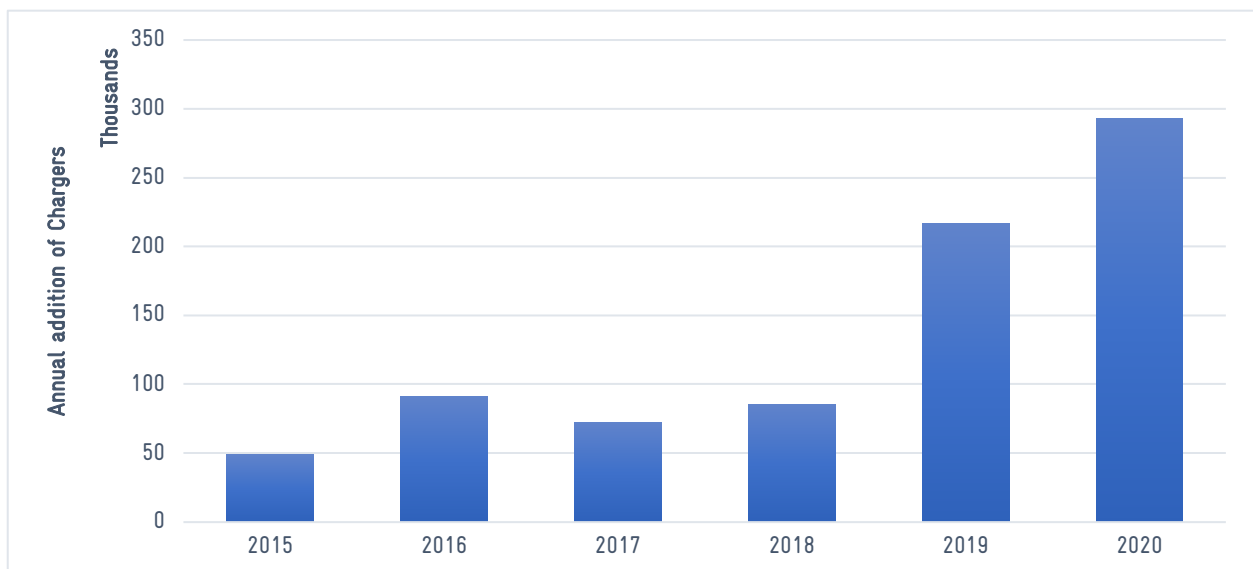

Figure 10.2: Annual installation of public chargers in China (based on Bloomberg data)

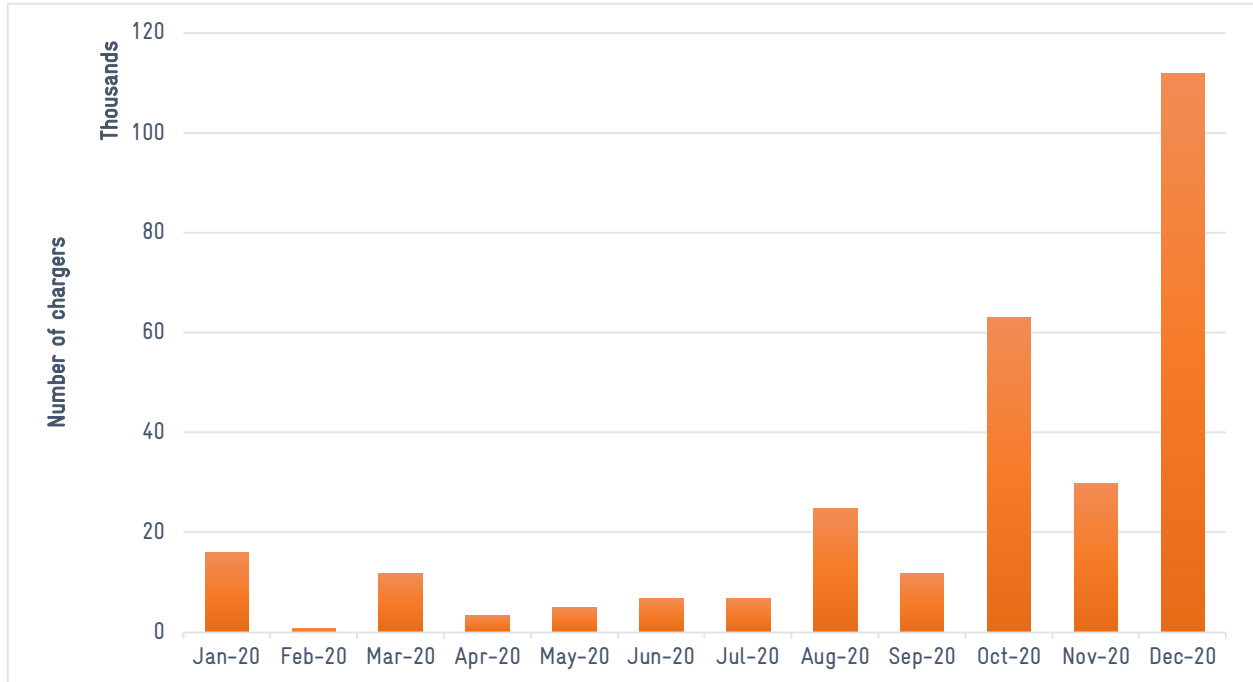

Figure 10.3: Monthly installation of chargers in 2020 in China (based on Bloomberg data)

Looking at the operators, T Good, Star Charge and State Grid operate almost 74% of all charging points in China, with a significant portion of them added in 2020 itself, Figure 10.4. Also, Star Charge has the highest share of fast DC charging points followed by T Good and State Grid, Figure 10.5.

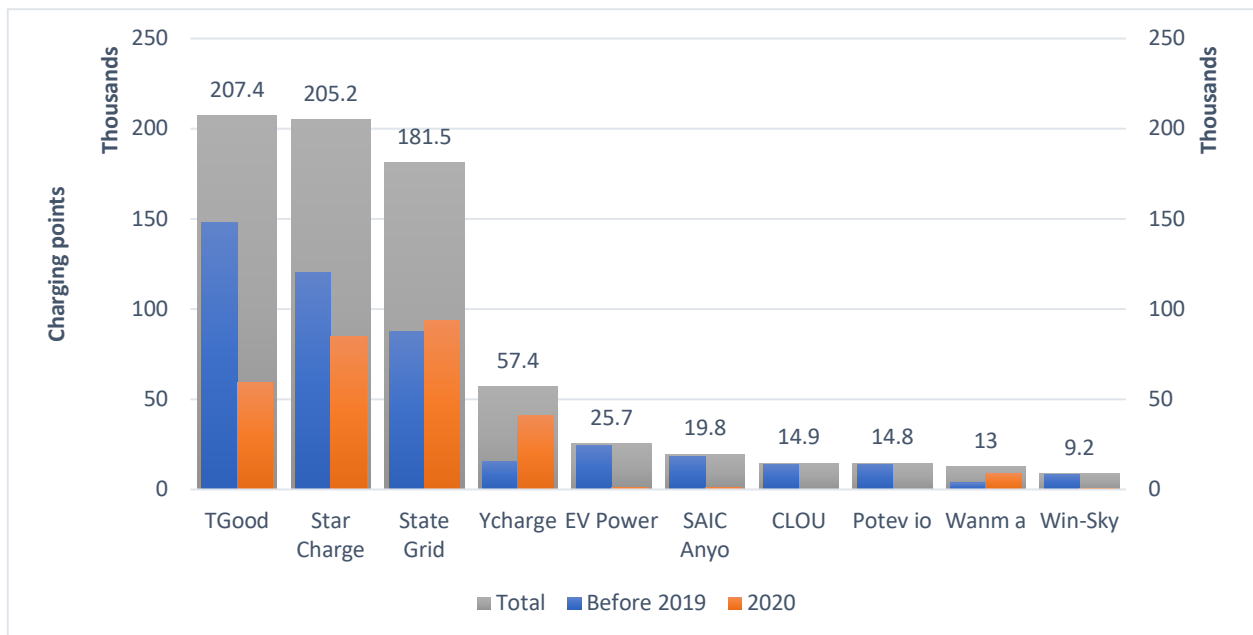

Figure 10.4: Share of charging points in China by operator (based on Bloomberg data)

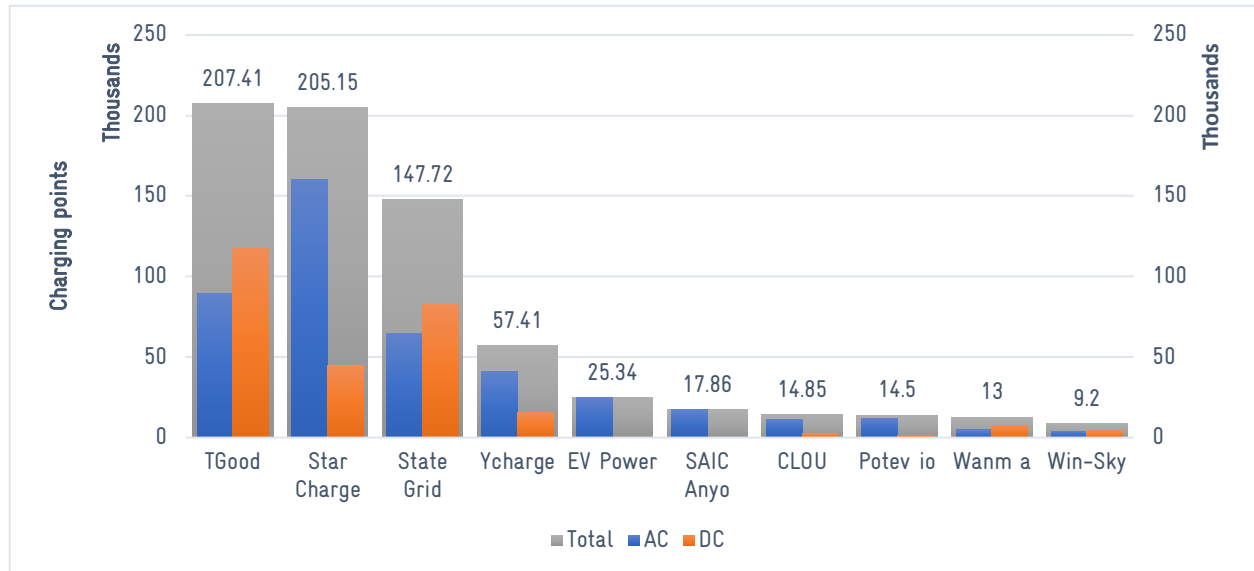

Figure 10.5: Share of charging points in China by charger type and operator (based on Bloomberg data)

In China the top tier cities have taken a lead in installation of public charger installations. At the end of 2018, Beijing, Shanghai and Guangdong Province accounted for just under 40% of charging posts nationwide.

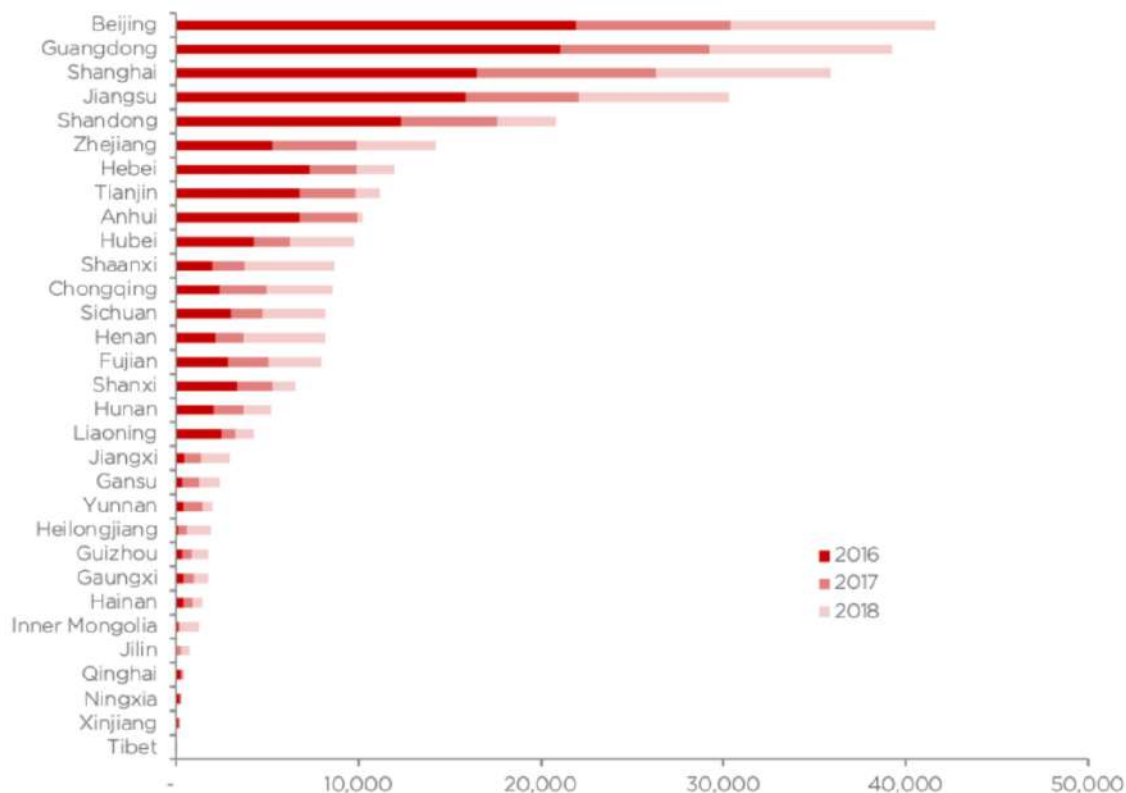

Figure 10.6: Number of public and dedicated fleet chargers per city/province (Hove & Sandalow, 2019)

China has also extensively put charging stations in all of its major highways as shown in Figure 10.7. Most of the highways to China's major cities have now been provided with EV charger. The usage of these chargers is heaviest on weekends and major public holidays.

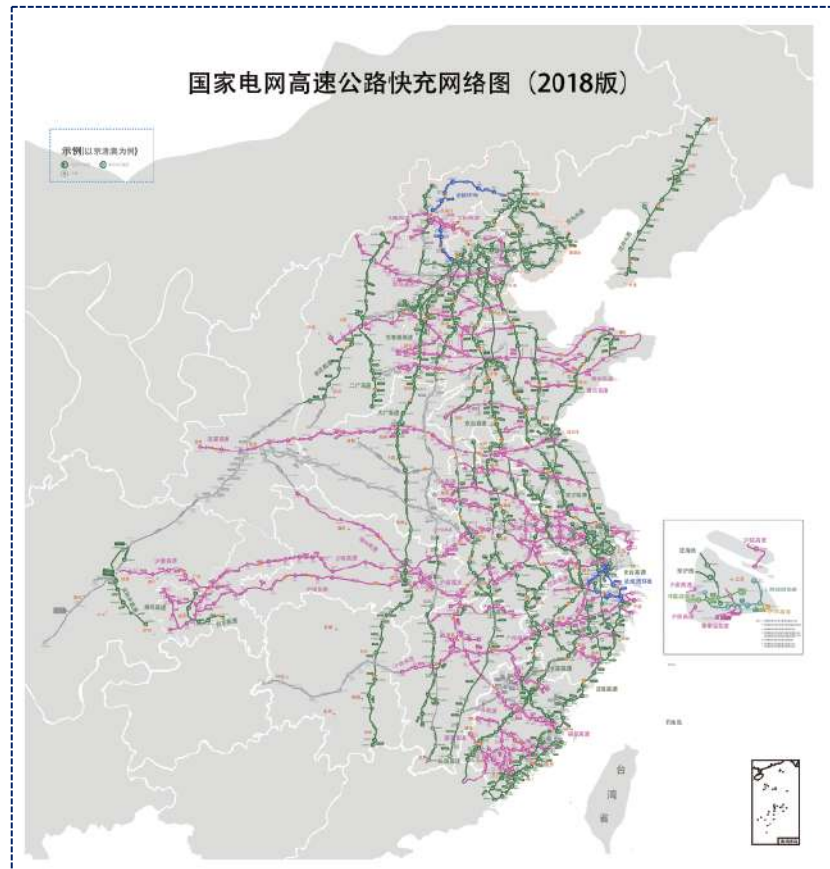

Figure 10.7: China State Grid highway charging corridor (early 2018) (Hove & Sandalow, 2019)

Unlike the rest of the world, China has its own charging standard called GB/T which was released in 2015. It has now been mandated for all EVs sold in China to be compatible with this standard. GB/T allows fast charging up to a maximum of 237.5 kW at 950 V and 250 A (Hove & Sandalow, 2019).

CHAdeMO along with China's GB/T released the new ChaoJi plug. It follows the protocol of CHAdeMO 3.0 which was released on 24th April 2020, allowing current flow of up to 600A. The latest version of the CHAdeMO protocol allows fast charging at 500kW while making the connector lighter than the earlier CHAdeMO connector with bi-directional support. The protocol also ensures the backwards compatibility of other DC fast charging standards (CHAdeMO, GB/T and also possible CCS) (CHAdeMO, n.d.).

10.4 EV demand status

The Chinese EV market has experienced a compound annual growth rate of 114% between 2012 and 2017. In 2015 China surpassed the US in total EV sales, and in 2017 it was responsible for 48% of worldwide electric light-duty vehicle sales. China accounted for 51% of global EV sales in 2018 (Hertzke et al., 2019) and the share of EVs in China is growing. The Chinese government has offered direct monetary incentives to support the purchase of EVs, including one-time subsidies and purchase tax exemptions, as well as non-monetary incentives, such as restrictions on registrations for ICE vehicles. As part of a gradual phase out of direct incentives set out in 2016, China reduced EV purchase subsidies in 2019. In 2019, BEVs accounted for 3.9% of the country's total market share and PHEVs accounting for 1.1% (IEA, 2020). Figure 10.8 illustrates China's EV stock by engine type.

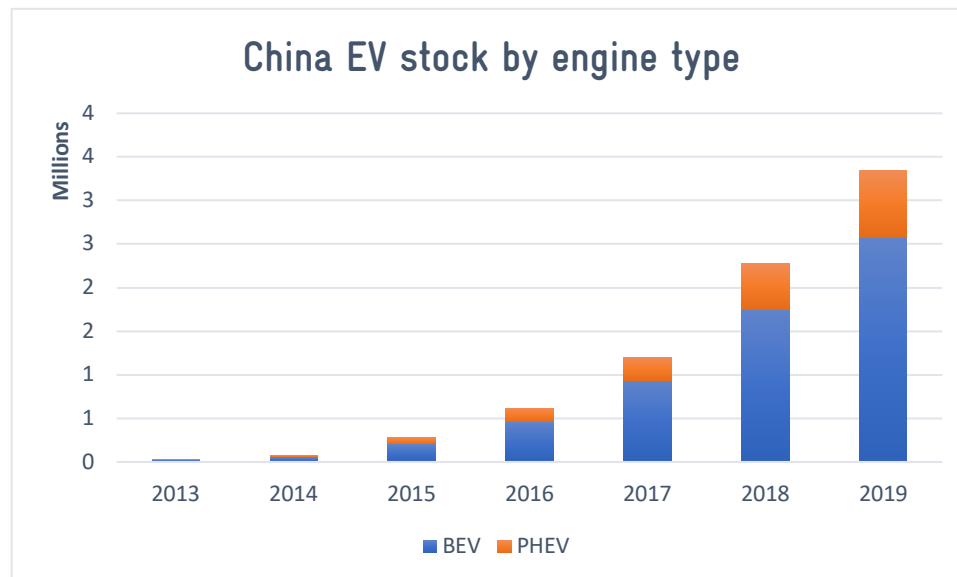

Figure 10.8: China EV stock by engine type,(IEA, 2020)

10.5 EV integration

The New Energy Vehicle Industry Development Plan for 2021 to 2035 targets a reduction of average power consumption EVs from 15kWh/100km to 12.0 kWh/100 km while EV sales are expected to increase from 5% to 20% of total new car sales (ICCT, 2021). The State Grid Corporation of China (SGCC) plans to deploy 300,000 EV smart charging stations as part of its smart charging network and has the world's extensive smart charging network linking charge point operator with EV users (Shumin, 2020). The network is connected to around one million charging

stations and serves 5.5 million EV users, 93% of China's public charging infrastructure and 43% of China's private charging stations. The open access platform uses smart grid technology to guide EV users to charge during off-peak hours at cheaper tariffs.

Time-of-use tariffs can significantly reduce peak demand by coordinating charging windows among EVs that charge in the evening and night periods can moderate risks of grid congestion as shown in Figure 10.9 which shows the contribution of EVs to hourly peak demand across various regions.

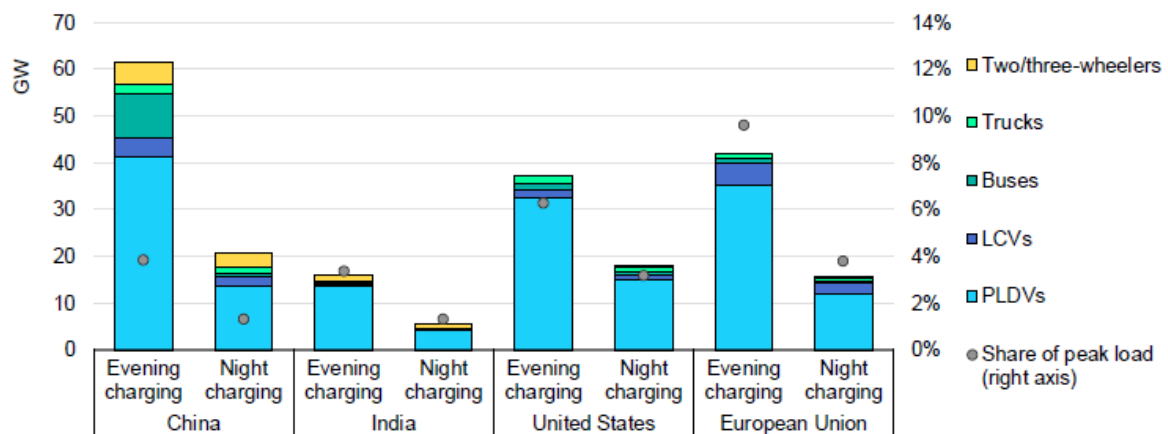

Figure 10.9: Contribution of EVs to hourly peak demand by country/region in the evening (IEA, 2020)

To defer grid upgradation requirements, the authorities in Beijing conducted an analysis to quantify the impact of V2G on the distribution network. As per their analysis, a typical residential quarter in Beijing considering 100% residences having an EV would have a peak load of around 4200 kW. Using, ToU charging, this peak load could be reduced to 3700 kW (considering 100% EV are responding to ToU signals) as well as shift the peak load to different time periods. With managed smart charging the peak load can be further reduced to 2274 kW, with just 75% of participation. However, if V2G is provided by just 20% of EV users then the complete EV load can be managed without adding to the residential load.

Impact of EV charging on GHG emissions under different scenarios of RE generation and charging methodologies

In this study the environmental impacts of fast and slow charging have been explored under different penetration cases of wind energy (Chen et al., 2018). The Chinese EV market has seen rapid growth due to the active role played by the Chinese government and this growth has been seen among all types of vehicles

(2W, 3W, 4W, buses). However, the steady rising growth of EVs in China is also going to increase the annual generation. The impact of EVs to reduce global greenhouse gas (GHG) emission will be dependent on the source of this power. If thermal generating stations are used to power the EVs then the expected benefit of EVs reducing GHG emissions may not be achieved. Increased investment in wind could have an important influence on the impact of EVs in China. ~

In this study, the field investigations were performed to determine the driving patterns for buses, taxis, and light duty vehicles in China. These driving patterns were then used to estimate a probabilistic charging behavior for vehicles of different fleets under different charging conditions as shown in Figure 10.10. The projection for the number of buses, taxis and LDV were 30,000, 66,000 and 5.6 million, respectively. Each vehicle type also has its own associated projected distance travelled annually. It has been estimated that LDVs, taxis and buses travel 18,000, 58,000 and 126,000 km/year/vehicle on an average. Based on the distance travelled the charging needs of each vehicle type have also been estimated accordingly

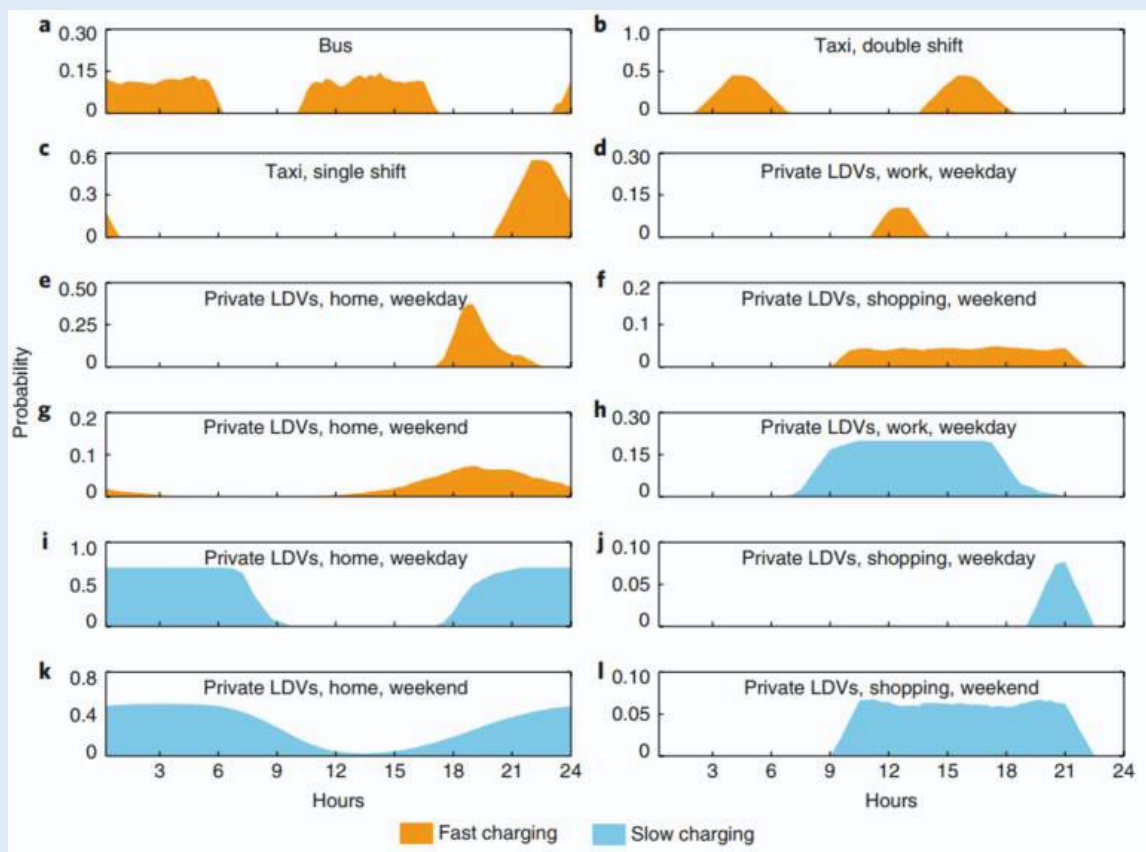

Figure 10.10: Probability of charging for different vehicle types with different charging options (Chen et al., 2018)

To meet with the load, the network is equipped with thermal generating stations and wind power plants. The details of the generating units have been taken from the Jian-Jing-Tang region that covers Beijing and

its surrounding areas. Based on the hourly load and the simulated EV load created using Monte-Carlo simulation, the different penetration of wind power, an energy optimization model has been designed to optimally schedule the generation of the power plant. The objectives of the optimization problem are the reduction of operational cost, reduction of wind curtailment and reduction of emissions.

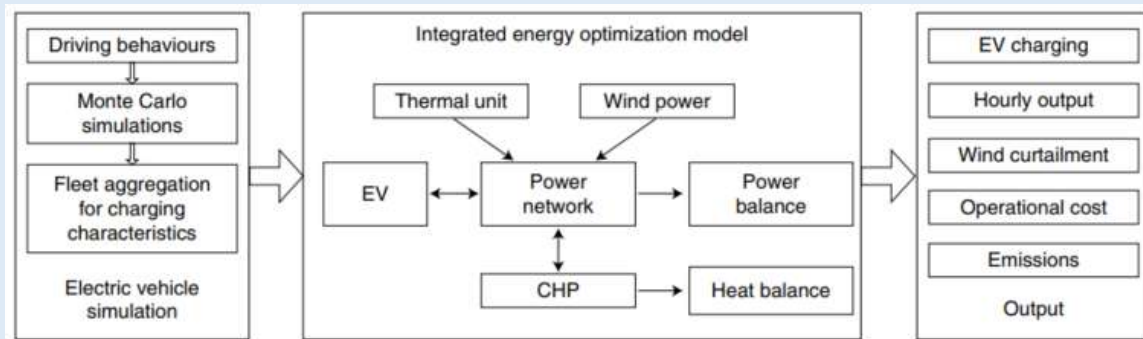

Figure 10.11: Modelling framework of the energy system optimization(Chen et al., 2018)

Different scenarios have now been considered to study its impact as shown in Table 10.2. The wind penetration has also been varied from 0% wind to 40% wind penetration.

Table 10.2: Scenarios considered

Scenario	Fleet Type	Fuel Type	EV charging method
BAU	Bus	Diesel	-
	Taxi	Gasoline	-
	Private LDV	Gasoline	-
Pub-f	Bus	Partly electric	Fast charging
	Taxi	Electric	Fast charging
	Private LDV	Gasoline	-
Prv-f	Bus	Diesel	-
	Taxi	Gasoline	-
	Private LDV	Partly electric	Fast charging
Prv-s	Bus	Diesel	-
	Taxi	Gasoline	-
	Private LDV	Partly electric	Slow charging
Cmb-f	Bus	Partly electric	Fast charging
	Taxi	Electric	Fast charging
	Private LDV	Partly electric	Fast charging
Cmb-s	Bus	Partly electric	Fast charging
	Taxi	Electric	Fast charging
	Private LDV	Partly electric	Slow charging

The reduction of GHG emission for the different scenarios have been given Table 10.3. As seen, without wind energy, the CO₂ emission has seen an increase,

BAU	0	10	19	25	29	0	5	9	12	14
Pub-f	-0.2	10	19	25	30	10	15	19	22	24
Prv-f	-3.2	5	12	16	19	0.5	5	7	10	11
Prv-s	-2.7	8	18	25	30	0.7	6	10	14	16
Cmb-f	-3.4	6	12	17	20	11	15	18	20	22
Cmb-s	-2.7	8	18	26	31	11	16	21	24	27

10.6 Case Studies

10.6.1 UK/China Project on Battery Characterization and Management.

Project aim:

The project aims to determine the anticipated patterns of battery cycling associated with vehicle use and provision of ancillary services including frequency support and peak shaving. Second, the study investigates the impact of V2G operation on the battery cell, module and pack cycle life, failures, and thermal behavior. Furthermore, the study investigates the communication and control temporal and physical information requirements from the battery management system (BMS) to the grid control system.

Project Overview: The project is supported by Engineering and Physical Sciences Research Council (EPSRC) in the UK and National Natural Science Foundation of China (NSFC) and investigates lithium battery cell development and degradation under Vehicle to Grid (V2G) operation. The study also explores grid scale energy storage, from a battery perspective and demonstrates V2G operation within distinct UK and Chinese environments and employs the BMS software with cycling/thermal control, and improved SoC/SoH prediction.

Key Learnings: The dual use of electric vehicle energy storage, V2G operation encompasses the aggregated use of battery elements on BEVs and PHEVs as a grid scale storage. V2G has many technical challenges to overcome as well as requiring careful cost benefit analysis of the effect of increased charge/discharge cycling of the battery, and associated degradation, versus the grid support benefits achieved.

Chapter 11. Comparative Analysis

This chapter provides a comparative analysis of the charging infrastructure among the different countries and the impacts of integration of the charging infrastructure with the power grid.

11.1 EV Charging Infrastructure

For comparative analysis, charging points have been categorized based on their power output as given below.

- Slow Chargers (<7 kW)
- Fast Chargers (7 -22 kW)
- Moderate chargers (0 - 22 kW)¹⁸
- Rapid Chargers (> 22 kW)

Figure 11.1 and Figure 11.2 gives a comparative analysis of charging infrastructure and the chargers per EV across all 8 selected countries. Undoubtedly China has the most extensive EV charging infrastructure with a strong emphasis on public rapid chargers along with moderate chargers.

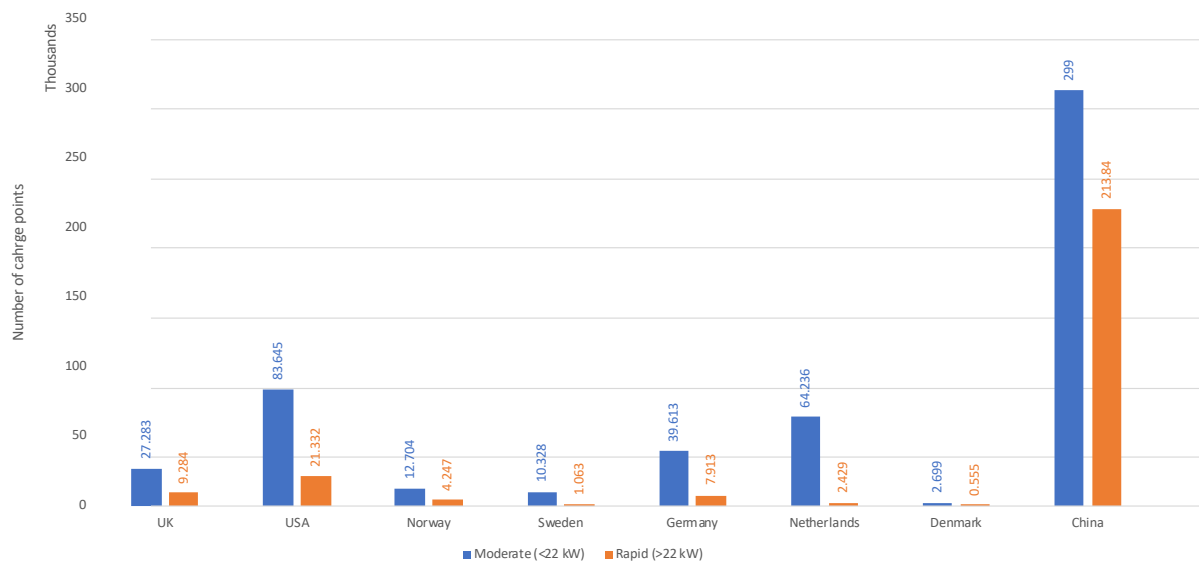

Figure 11.1: Public charge points based on power rating among different countries¹⁹

¹⁸ This particular category has been added as some of the countries present their charging infrastructure based on just two categories, i.e. chargers with power rating less than 22 kW and chargers with power rating more than 22 kW.

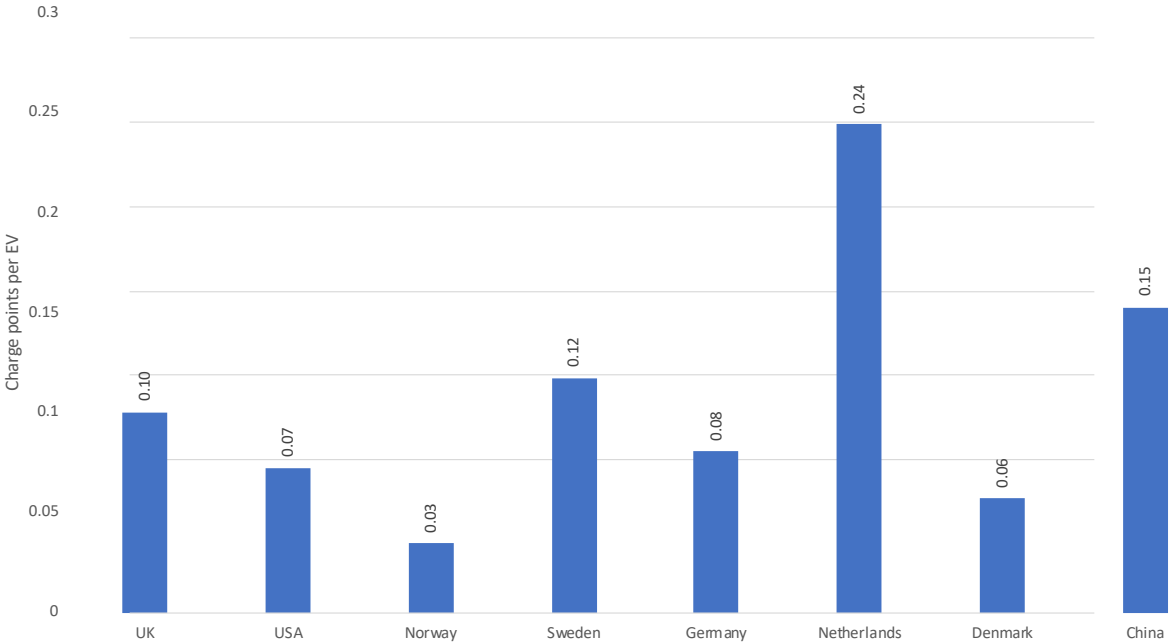

Figure 11.2: Charge points per EV in the different countries ¹⁹

The number of charging points and the percentage share of each charger type for UK, USA, Norway, Sweden, and Germany are shown in as shown in Figure 11.3. and Figure 11.4 respectively²⁰. It is evident that fast chargers are the most prevalent public EV charger category followed by rapid chargers, while slow chargers constitute the least share in the public charging infrastructure.

For the information depicted from Figure 11.3 to Figure 11.14, IIT Bombay had undertaken research and the data has been collected from different sources including international agencies, government statistics, relevant official websites, utilities and stakeholder consultation. Due to insufficient data available from a few countries, the analysis has been restricted to only select 5 countries: UK, USA, Germany, Norway and Sweden.

¹⁹ Source: IIT Bombay research. The data has been collected from different sources including international agencies, government statistics, relevant official websites, utilities and stakeholder consultation.

²⁰ The data for number of chargers and number of EVs in UK, USA, Norway and Sweden are as of Feb, 2021, while the data for Germany is as of 2019.

The number of EVs for each of the 5 target countries is given in Figure 11.5. Comparing the number of EVs to the number of publicly available chargers, the number of slow, fast and rapid charger per EV are shown in Figure 11.6, Figure 11.7 and Figure 11.8 respectively. Although the number of EVs in USA is the highest, its charging infrastructure has grown enough to have a higher number of public fast and rapid chargers available per vehicle compared to Norway which has the second highest number of EVs. However, comparatively UK has the best rapid charger network, as it has the highest number of rapid chargers per EV. The ranking of each country for the three main categories of the chargers (slow, fast and rapid) are given in Figure 11.9. Among the 5 countries, UK has the maximum slow and rapid charging infrastructure with approximately 50 and 56 EVs per rapid and slow charger respectively, while Sweden has the best fast charging infrastructure with 10 EVs per public fast charging outlet.

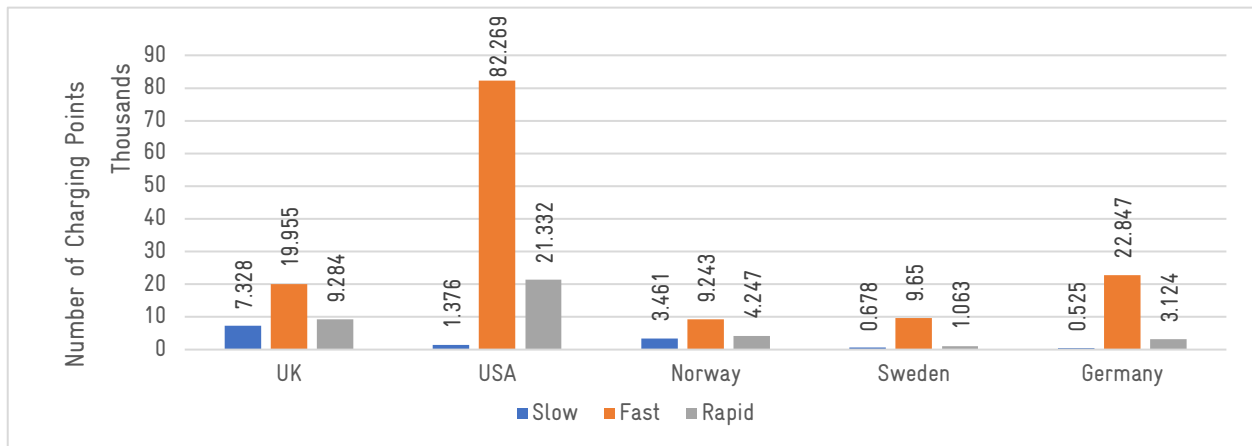

Figure 11.3: Public charging infrastructure in different countries¹⁹

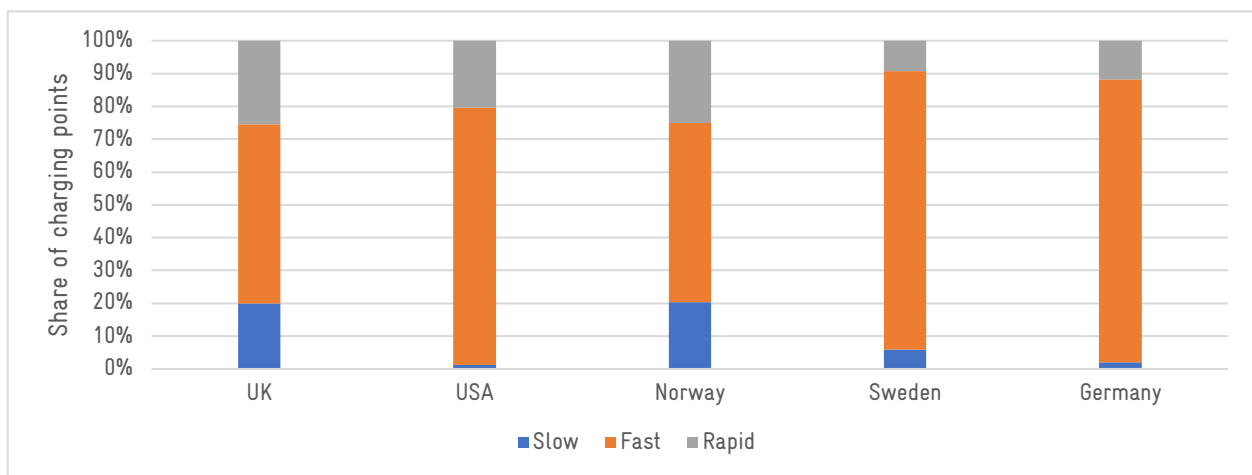

Figure 11.4: Charger power ratings in public charging station for each country ¹⁹

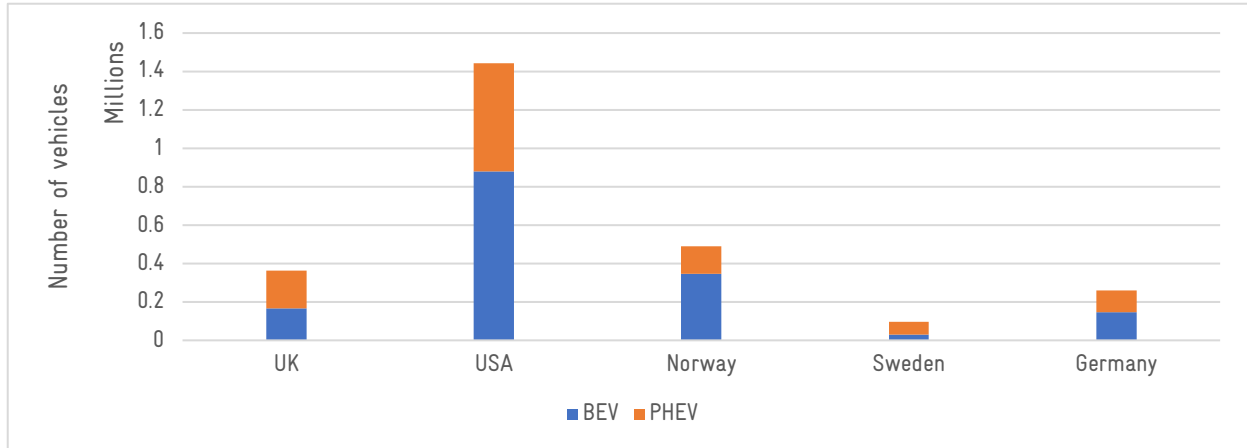

Figure 11.5: Number of EVs in the different countries ¹⁹

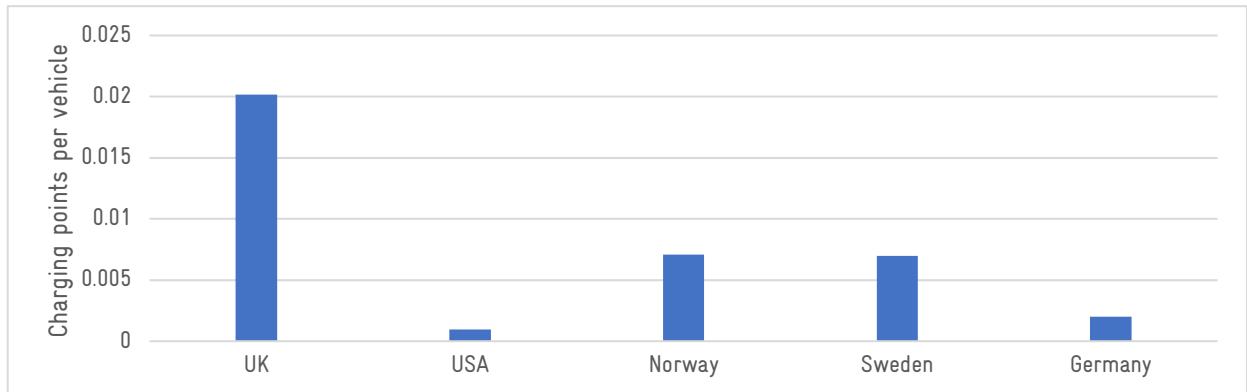

Figure 11.6: Number of public slow charging points per EV (higher is better) ¹⁹

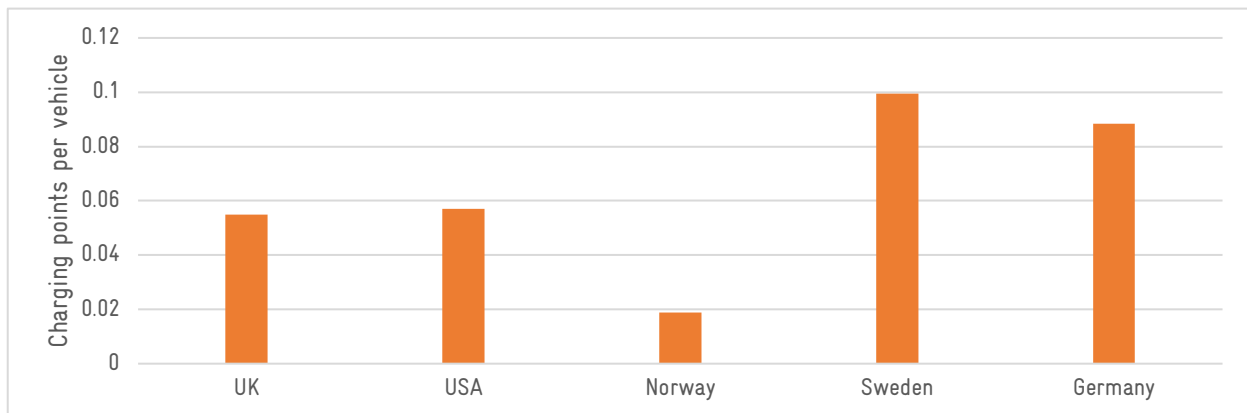

Figure 11.7: Number of public fast charging points per EV (higher is better) ¹⁹

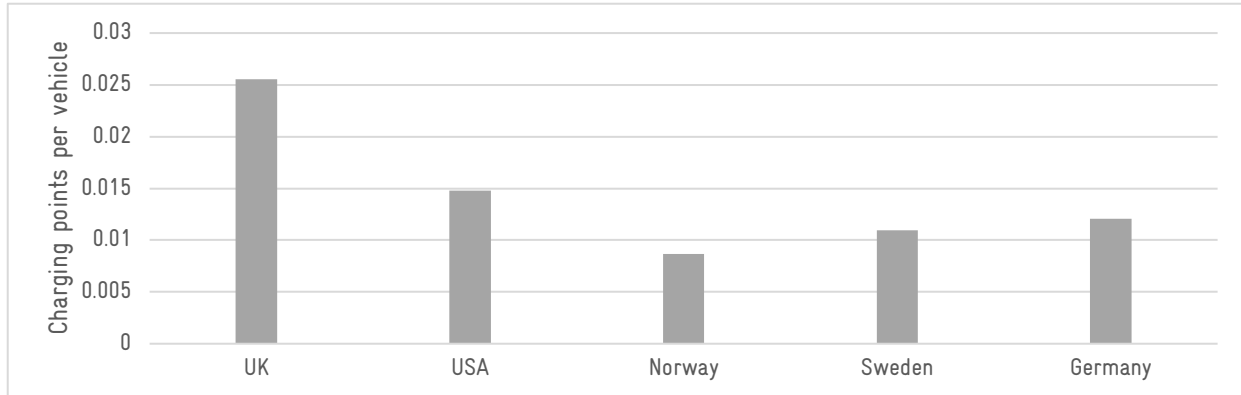

Figure 11.8: Number of public rapid charge points per EV (higher is better) ¹⁹

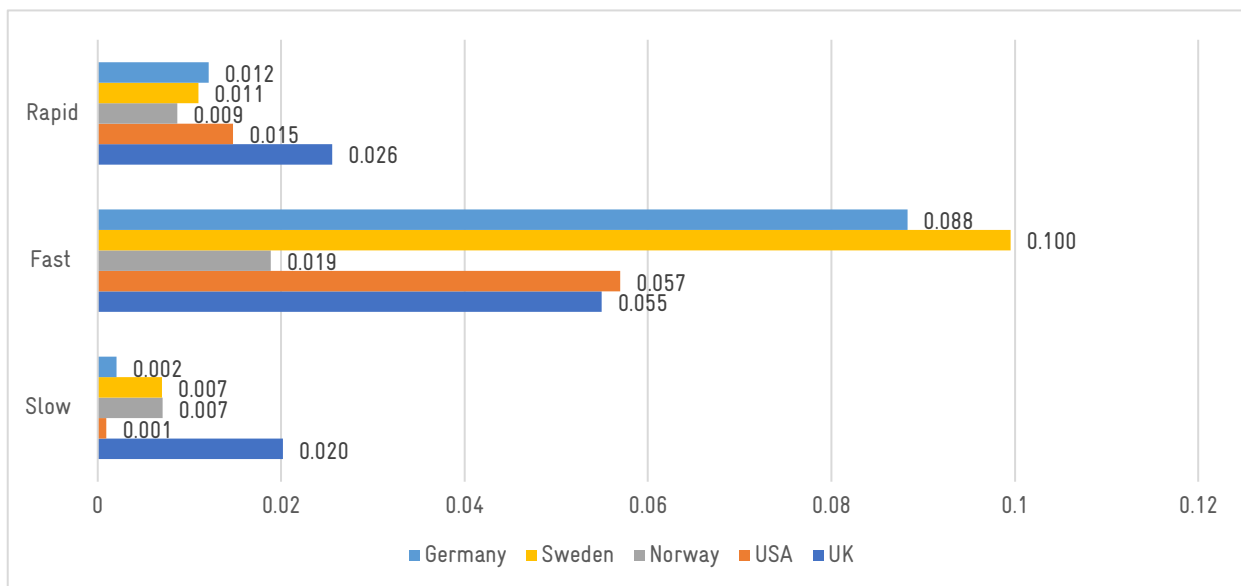

Figure 11.9: Comparison of number of charge points per vehicle among the 5 countries ¹⁹

In regard to private charging, as analyzed by IEA, there are 1.1 private chargers for each private EV. These private chargers are provided by the respective EV manufacturer and can be installed at either the residential premises of the user or in the workplace or both. The number of private chargers for EV have already been given in Figure 1.5. Besides the private chargers, it is also important to analyze the public charging infrastructure in comparison with private vehicles. The number of private vehicles per slow, fast, rapid and total public chargers for the different countries are given in Figure 11.10, Figure 11.11, Figure 11.12 and Figure 11.13. Here too it is seen that, among all the countries slow chargers form the weakest public charging infrastructure. Figure 11.14 shows the preference of the charger types used in public charging infrastructure in the

different countries which shows that, globally fast chargers (between 7 kW and 22 kW) is the most preferred. Although the share of slow and rapid chargers is comparable, it needs to be mentioned that slow chargers were deployed during the earlier years when the EV proliferation was still minimal, but rapid chargers have witnessed a rapid growth in the past 4-5 years.

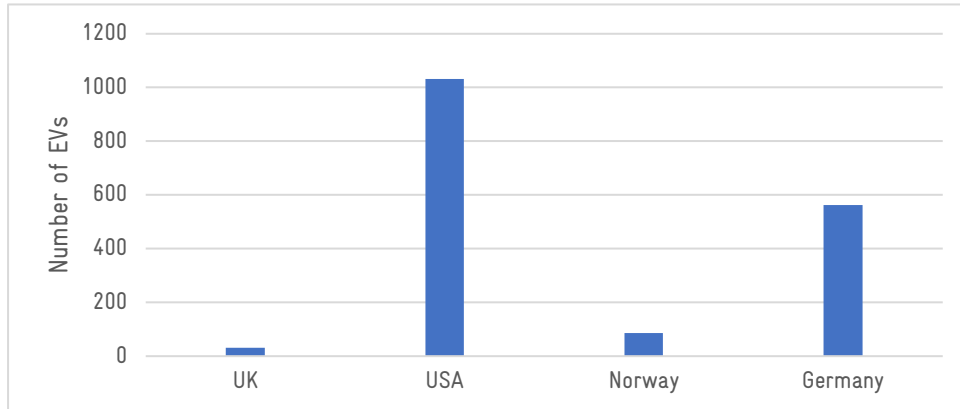

Figure 11.10: Number of private EV per public slow charger ¹⁹

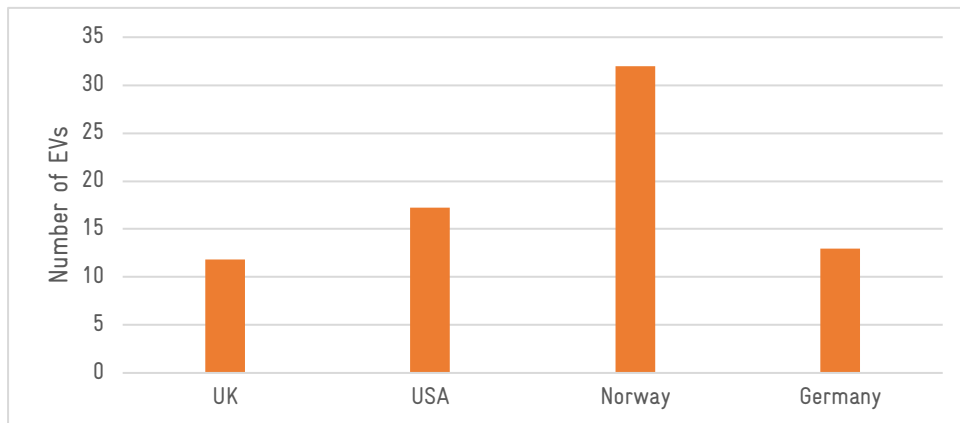

Figure 11.11: Number of private EV per public fast charger ¹⁹

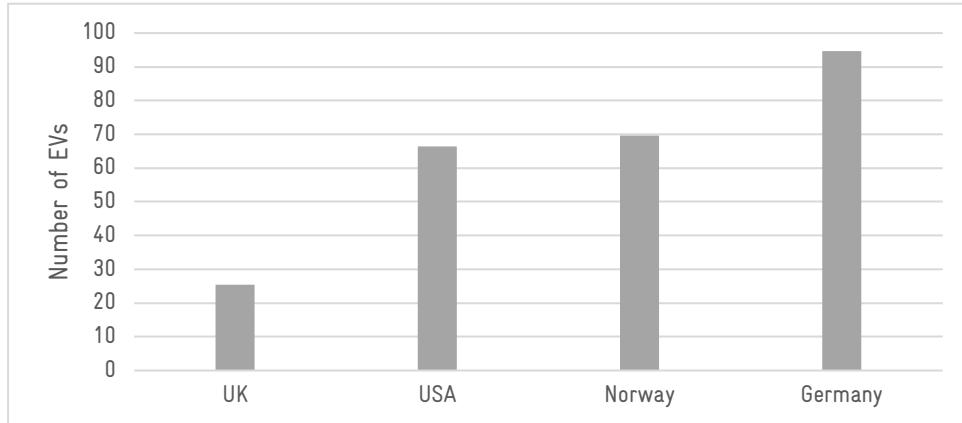

Figure 11.12: Number of private EV per public rapid charger ¹⁹

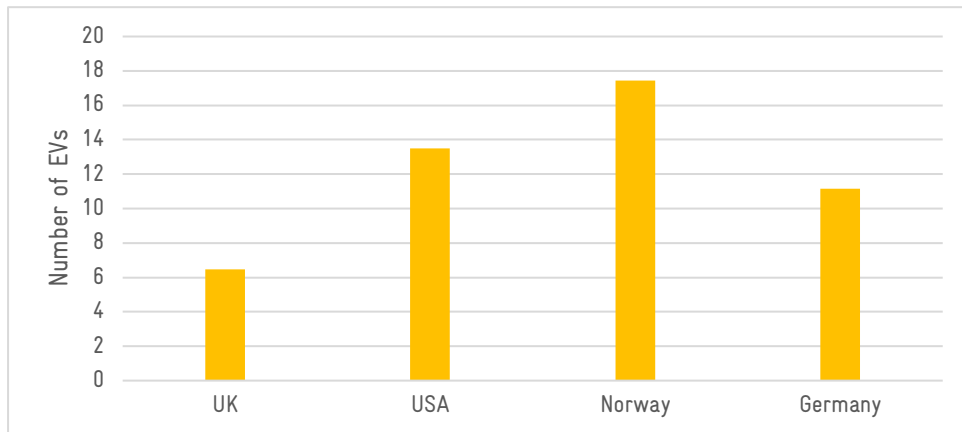

Figure 11.13: Number of private EV per public charger ¹⁹

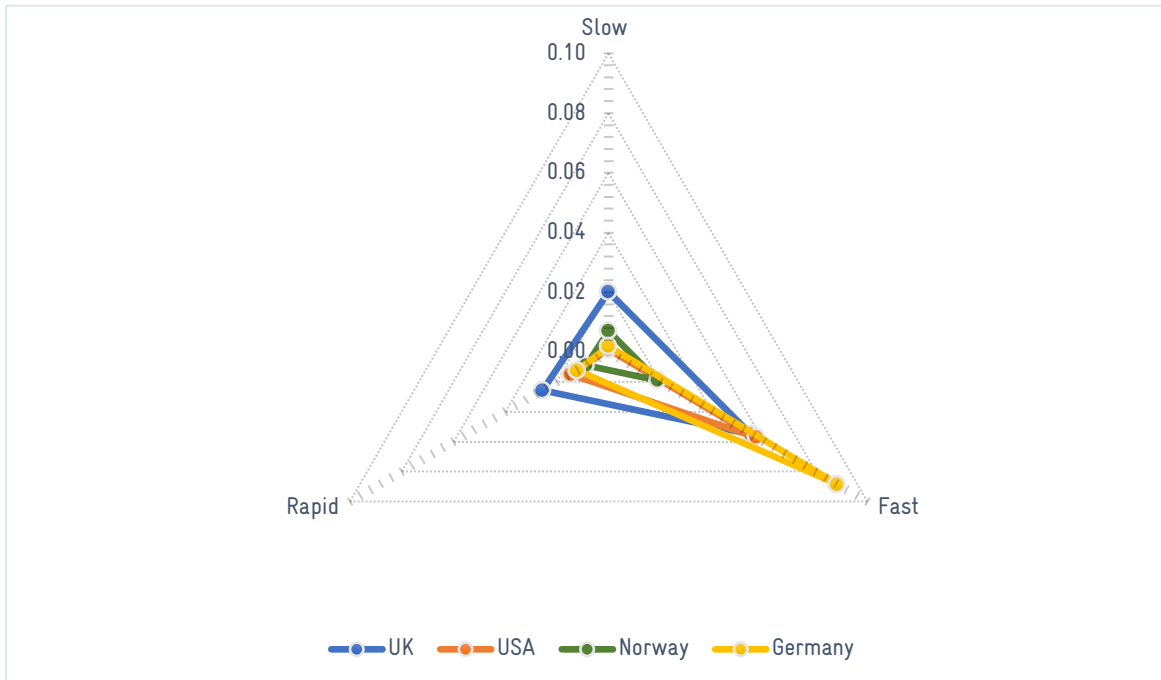

Figure 11.14: Radar map showing the number of chargers per vehicle for the different charger types i.e., the preference of charger types for each country ¹⁹

It is important to note that 6 of the top 10 countries that have invested in EV charging infrastructure are from Europe. In fact, most of the Europe has experienced a rapid growth of EV charging infrastructure as shown in Figure 11.15

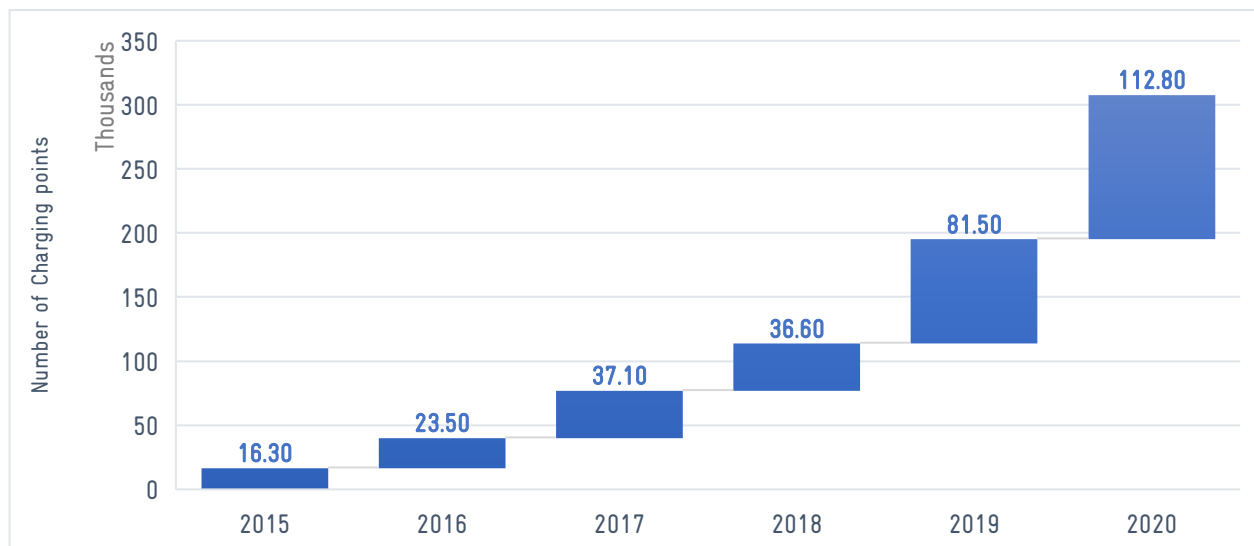

Figure 11.15: Annual public connector installations across Europe (based on Bloomberg’s data)

Figure 11.16 shows the distribution of chargers in Europe based on their charging power and connector type. It can be observed that 22 kW is the most popular charging point power rating in

Europe. Moreover, it can be observed that up to 43 kW charger rating, all the chargers utilize a Type 2 connector. In the 50 kW bracket, the connector types are almost equally shared between CCS and CHAdeMO. The 150 kW chargers either utilize a CCS connector or are Tesla Superchargers.

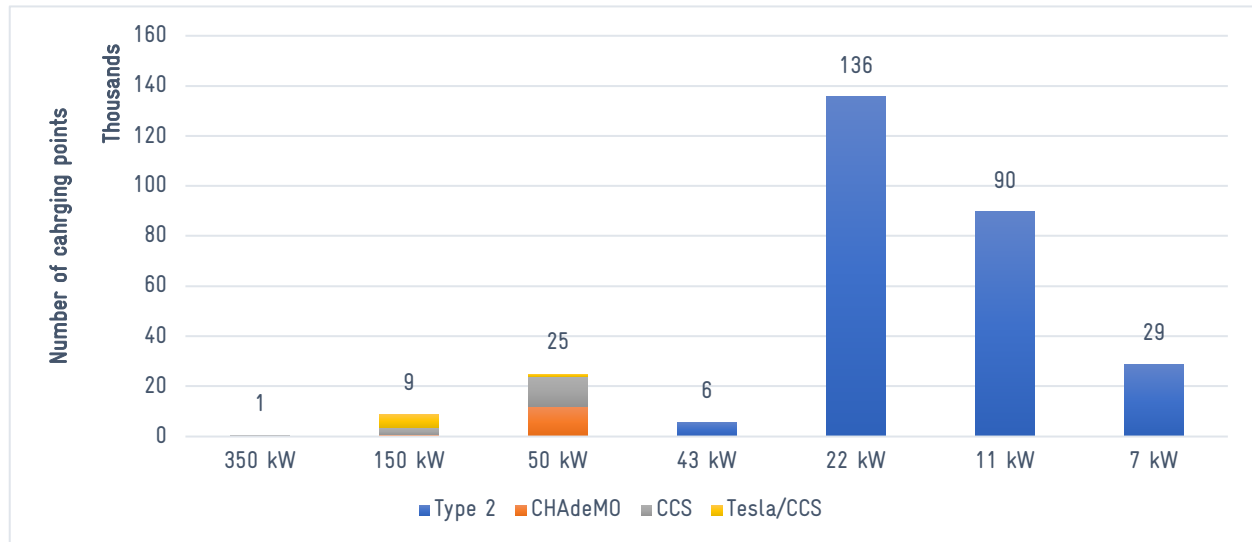

Figure 11.16: Public charging points in Europe as per charging power and connector type (based on Bloomberg's data)

11.2 EV Charge Point Operators

With the increase in the number of public charging points, it would also be prudent to understand the level of competitiveness of the EV charging business in these regions. Figure 11.17 and Figure 11.18 shows the number of operators with at least 3000 public charging points and 1000 public fast or ultra-fast charging points respectively. Europe has the most competitive market with the highest number of large charge point operators, but looking specifically at fast and ultra-fast charging networks, China has the higher share of operators. Therefore, it can be inferred that China has a more developed fast charging network, while in Europe only a limited share of operators are involved with fast and ultra-fast charging.

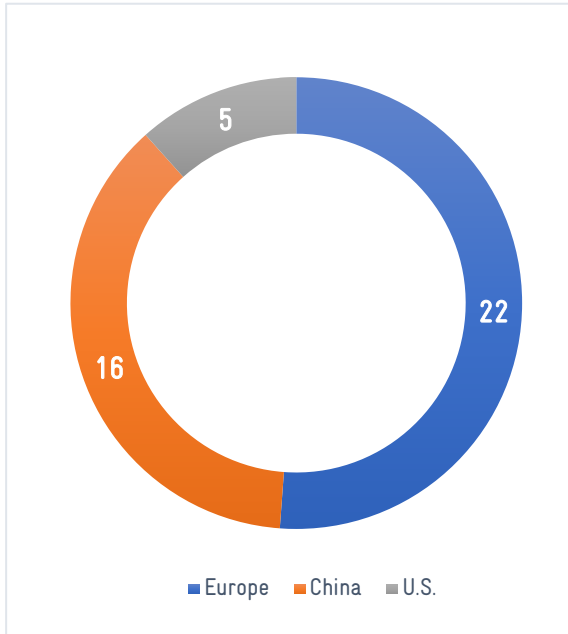

Figure 11.17: Number of operators with over 3,000 public charging connectors by region (based on Bloomberg's data)

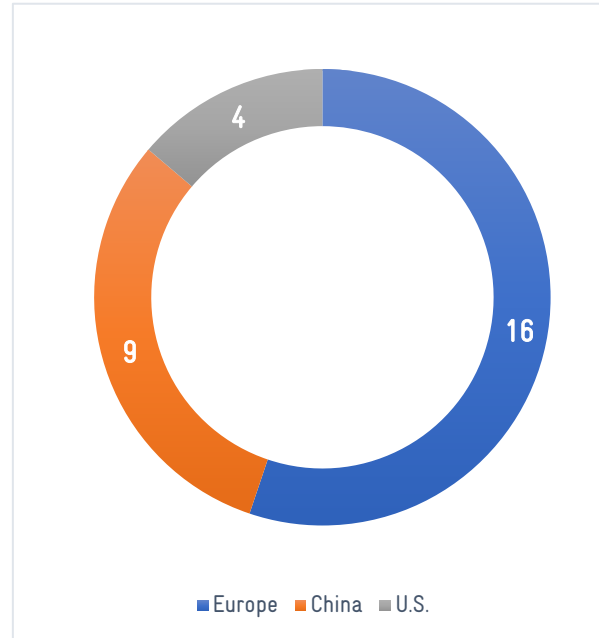

Figure 11.18: Number of operators with over 1,000 public fast or ultra-fast charging connectors by region (based on Bloomberg's data)

Looking at the key charge point operators in the different regions, it can be seen that overall Europe has a highly competitive market as no single operator has a significant share given in Figure 11.21 and Figure 11.22. While in USA, ChargePoint is the dominant player while taking all charging points into consideration. However, looking at fast and ultra-fast charger segment, Tesla has more than 50% market share given in Figure 11.19 and Figure 11.20.

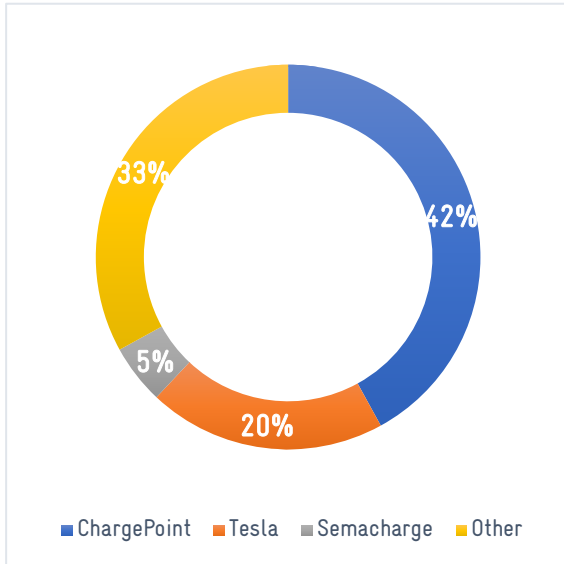

Figure 11.19: Market share of public charging operators in USA across all charger types (based on Bloomberg's data)

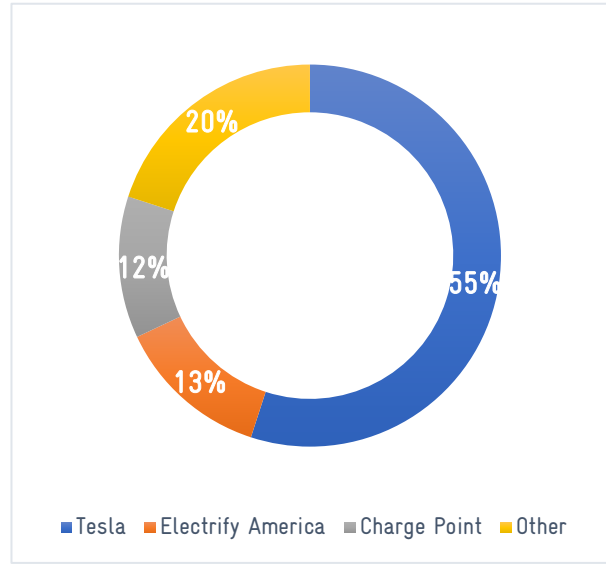

Figure 11.20: Market share of public charging operators in USA across fast and ultra-fast charger types (based on Bloomberg's data)

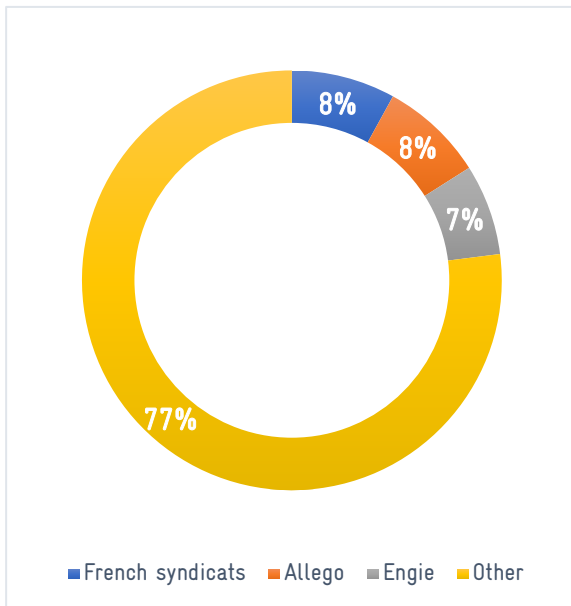

Figure 11.21: Market share of public charging operators in Europe across all charger types (based on Bloomberg's data)

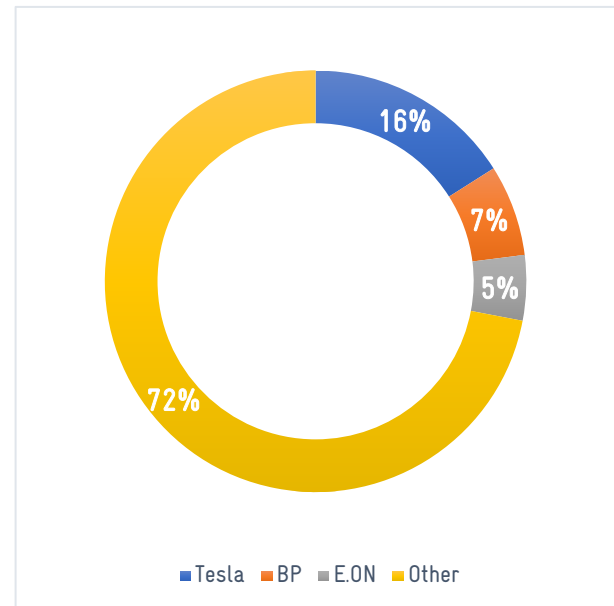

Figure 11.22: Market share of public charging operators in Europe across fast and ultra-fast charger types (based on Bloomberg's data)

In China, there are three major players, TGood, Star Charge and the State Grid (Chinese state-owned electricity utility) with an almost equal share of charger points, with TGood having a higher share for fast and ultra-fast charging points as given in Figure 11.23 and Figure 11.24.

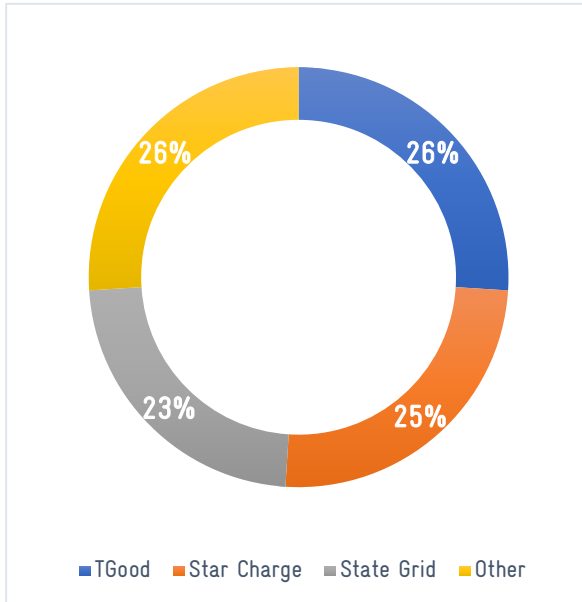

Figure 11.23: Market share of public charging operators in China across all charger types (based on Bloomberg's data)

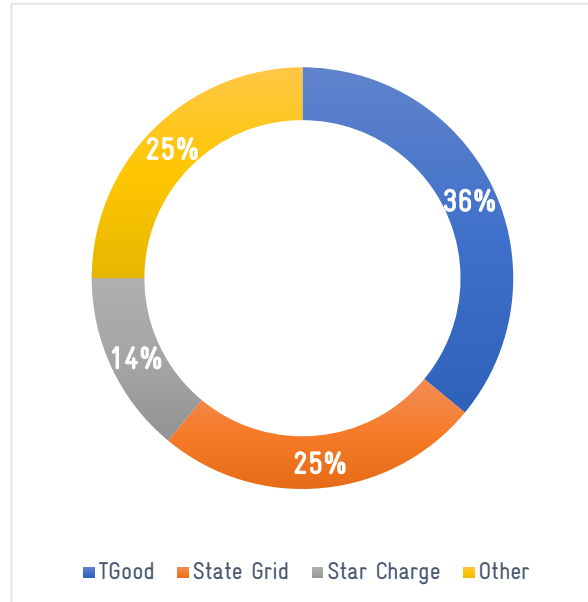

Figure 11.24: Market share of public charging operators in China across fast and ultra-fast charger types (based on Bloomberg's data)

Figure 11.25 shows the average electricity delivered by each charger per day for the different charge point operators and also the average utilization of these chargers. It can be observed that the charge point operators with DC chargers have a higher daily energy throughput per charger. However, the utilization of these chargers is still quite low at less than 10% for most charge point operators, except Volta which has seen average utilization of 21%. In comparison, in China the average utilization is a bit higher at more than 10% as given in Figure 11.26. Winline which is a charge point operator with primarily DC chargers have seen average utilization factor of 38%.

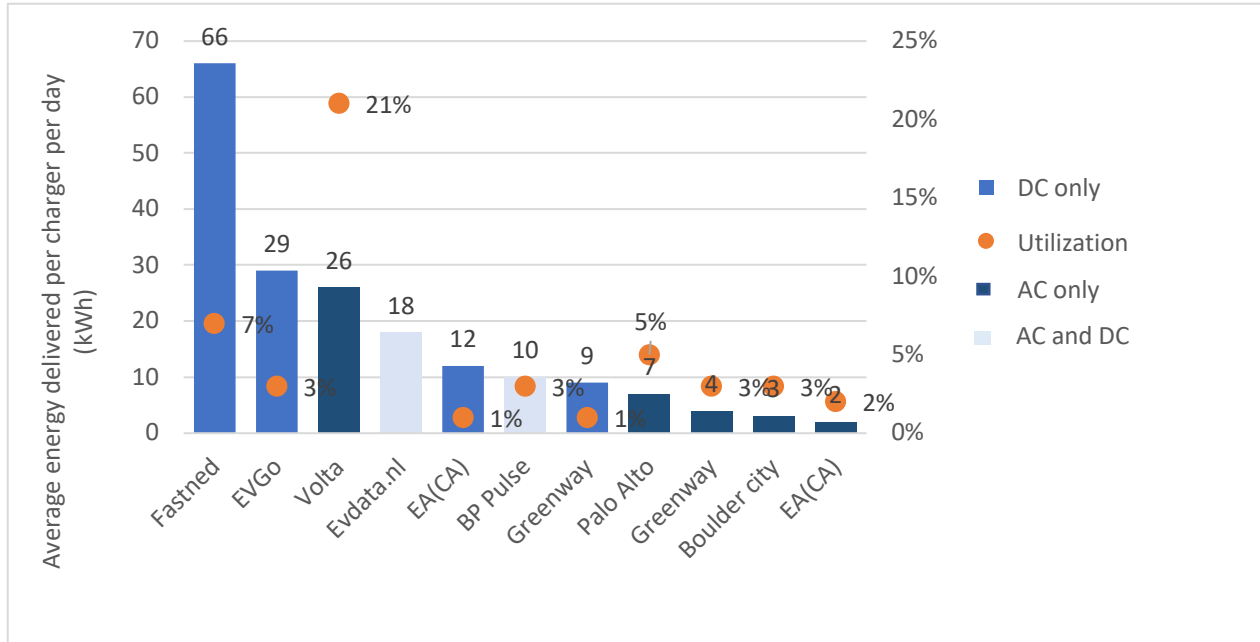

Figure 11.25: Average energy delivered per day per charger by different charge point operators in USA and Europe along with their utilization (based on Bloomberg’s data).

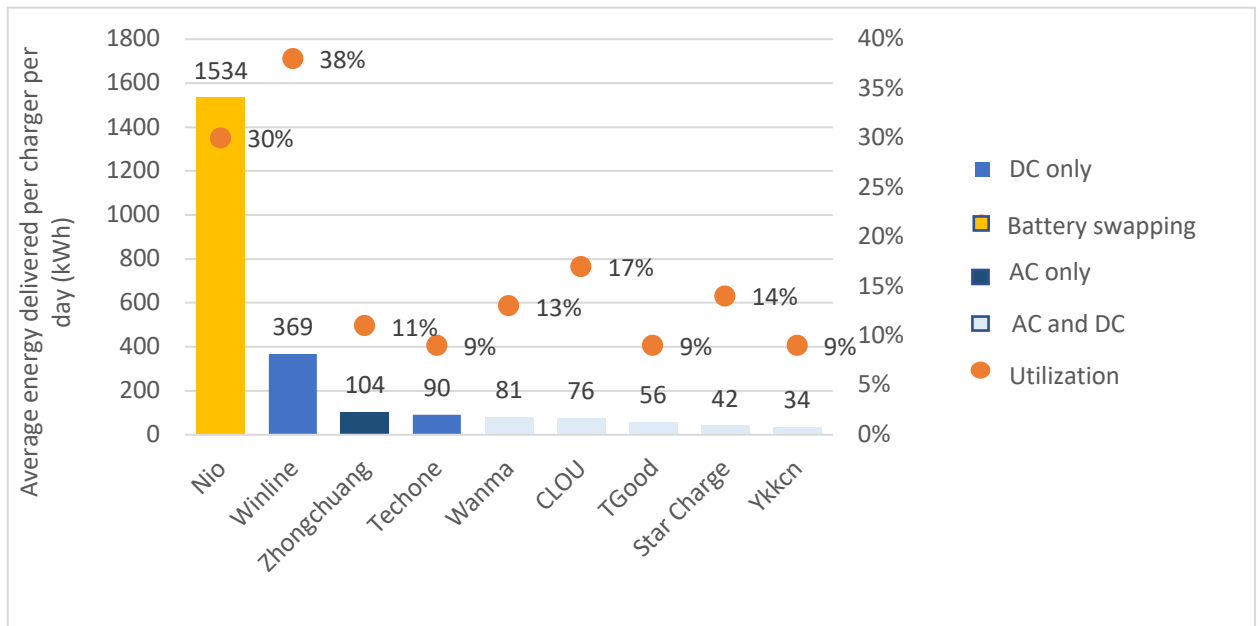

Figure 11.26: Average energy delivered per day per charger by different charge point operators in China along with their utilization (based on Bloomberg’s data).

With the rapid growth of EV charging seen above, it is important to analyze the energy consumption by EV charging load. It is expected that energy required for EV charging would rise

up significantly in the next 10 years, as shown in Figure 11.27. With an expected rise of public chargers by 167%, 317% and 872% in China, Europe and US by 2030 over 2020, the energy required is expected to rise by 1592%, 2477% and 2194% respectively.

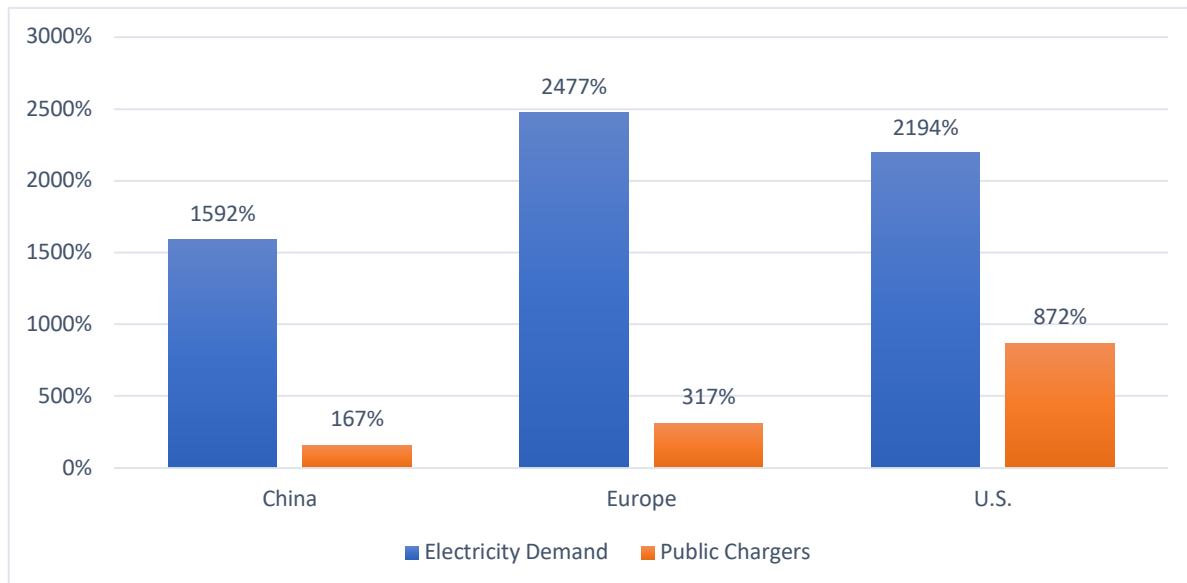

Figure 11.27: Growth of electricity demand and number of public chargers by 2030 compared to 2020 (based on Bloomberg's data).

With the increase in power requirements for EV chargers, there is a need for investment in grid reinforcements and grid management. Integration of EV charging infrastructure with the power grid has many challenges and it is important to address them for successful deployment of EV charging infrastructure.

11.3 Policies for EV Charging Infrastructure

The deployment of EV charging infrastructure over the past decade was mostly driven by ambitious policies and goals. A few key policies have been described below.

11.3.1 China

The Chinese government has been aggressive in rolling out EV infrastructure by establishing clear roadmap. The local authorities across provinces are being mandated to increase their EV charging infrastructure support via the five-year plans. Besides public sector push, there is also encouragement for public-private partnerships initiatives. On the supply side, in addition to the national policy measures, over 30 cities in the country offer some financial incentives for private or public EV charging infrastructure. For example, Shenzhen provides INR 4,600/ kW (EUR 52.2/kW) as subsidy for DC chargers. In Beijing, all new residential developments are mandated

to reserve space for EV charging stations while new buildings owned by the government or state-owned enterprises must equip 25% of parking spots with EV chargers. Shenzhen offers EV users subsidies for installation of EV charging stations while Guangzhou requires all new buildings to either reserve or equip 18% of parking space with EV charging stations (Hove & Sandalow, 2019).

11.3.2 European Union

The European nations have their own policies in place for EV charging infrastructure, that have been designed in accordance to the targets of the European Union (EU). The Alternative Fuels Infrastructure Directive (AFID) has set EV charging infrastructure deployment targets for publicly accessible chargers for 2020, 2025, and 2030, with an indicative ration of 1 charger per 10 EVs.

EU has also rolled out stricter building byelaws on new and renovated buildings to have adequate EV charging infrastructure as described below.

Building byelaw of European Union

EU has established building byelaw for all the member states. However, every member state has to establish its own building code by 2025 (Hall & Lutsey, 2020). European Energy Performance of Building Directive (EEDBD) provided the EU building code in 2020. According to the building code given in 2020, a new residential building with more than ten parking spaces should be 100% EV ready. Spaces with cable routing and the mandate of charge point are not applied on residential buildings. The norm for new non-residential building with more than ten parking spaces states that the building should have at least one charging point and 20% EV ready parking spaces.

The Netherlands, being the member country in European Union, follows the building bye-law provided by EEDBD in 2020 as discussed above (NEA, n.d.).

Following the EU building directive, **Denmark** building regulation says that from 2023 all buildings with more than ten parking space should have at least one charging point (U. Andersen, n.d.).

Sweden introduced a modified building code in 2019 which states the minimum requirement of EV charging infrastructure at new buildings. Norm state that new residential building and renovated building with more than ten car parks should set up the electric wiring infrastructure such as ducts for electric cable in each car parking. This building should set up at least one charging point for each charging space. Local buildings with more than 20 car parks should establish one charging point per car park. This norm for the local (existing) building will be effective from 1st January 2025 (Boverket, 2019).

United Kingdom

The UK introduced new building bye-laws in July 2019 to address the increasing necessity and requirement of electric vehicle charging infrastructure (GOV.UK, 2019). The EU Energy Performance of Buildings Directive (EPBD) has issued the new building byelaws to make the building ready with EV charging infrastructure. This modified norm considered a new residential building, non-residential building, and existing non-residential building. Proposed building byelaw for various types of building is given further.

Residential Building: According to the norm, every new residential building with an associated parking space should have a charging point. This norm is also applicable to the building undergoing material changes to create a dwelling. Another part of the norm for existing residential building with more than ten parking spaces undergoing renovation says that cable-routing should be present at every parking space for EV charging point.

In a dwelling, the number of parking spaces with EV charging points should be at least a minimum of the total number of parking spaces and total dwelling served by the car park.

New Non-residential building: According to the norm, any new non-residential building and existing non-residential building with more than ten parking spaces undergoing major renovation should have one charging point and cable routes for one in five parking spaces.

A major renovation is defined as a change where more than 25% of the building area is changing. This definition of major renovation is in line with EPBD and building regulation. For considering change as a major renovation, 25% of it must lie in the category of car parking and electrical infrastructure associated with car parking.

Existing non-residential building: Norm states that existing non-residential building with more than 20 parking spaces should have at least one charging point from 2025.

11.3.3 United States of America

The United States of America has been one of the market leaders in the EV space, and has a dense EV charging network. Fueled by federal and state policies, different private players have emerged in the US to install EV charging stations. The US Congress in 2019, extended tax credit, covering up to 30% of the installation cost of an EVSE (capped at INR 74,400 (EUR 845)) till 2020. Besides, federal policies, different states have their own individual policies to boost the EV charging infrastructure.

The Los Angeles Department of Water and Power (LADWP) provides rebates to commercial customers toward the purchase of Level 2 or direct current (DC) fast EVSE. Commercial customers who purchase and install EVSE for employee and public use can receive up to INR 3,70,720 (EUR 4,210) for each Level 2 EVSE. The Los Angeles Department of Water and Power (LADWP) offers a discount of INR 1.85 (EUR 0.02) per kilowatt-hour for electricity used to charge PEVs during off-peak times. Residential customers who install a separate time-of-use meter panel will also receive a credit of INR 18,536 (EUR 210) (Afdc, 2021). In Colorado, a legislation has been passed that allows the electric public utilities to install EV charging stations as a regulated service, as this would enable the electric utilities to recover the costs incurred (State of Colorado, 2019). The different U.S. state level policies promoting infrastructure for alternative fuels have been presented in a hyperlinked map by the Centre for Climate and Energy Solutions (C2ES) (C2ES (The Center for Climate and Energy Solutions), 2019).

Building byelaws of United States of America

San Francisco, in California, USA, introduced a building code in 2018. As per the code, all new building and major renovations should be 100% EV-ready by cable routing and ducting or by using one fast charger for every 5 EV ready spaces.

The United States of America also has building bye-laws that differ as per the municipality in a state. More information of various building codes in the United States is given in Table 11.1.

Table 11.1: Building bye-law in different states of United States (SWEEP, n.d.)

Municipality	State	Year	Independent house / Single-family occupancy	Apartment/multifamily occupancy	Non-residential/Commercial buildings
Avon	CO	2021	Minimum 1 EV ready space per home.	For more than seven parking spaces, 5% spaces should have installed charging point setup, 10% spaces should be EV ready with cable routing, and 15% EV-Capable	For more than ten parking spaces, 5% spaces should have installed charging point setup, 10% spaces should be EV ready with cable routing, and 15% EV-Capable
St. Louis	MO	2021	Minimum 1 EV ready space per home.	2% spaces should have installed charging point setup, 5% spaces should be EV ready with cable routing (increases to 10% by 2025)	2% spaces should have installed charging point setup, 5% spaces should be EV ready with cable routing
Madison	WI	2021	-	2% spaces should have installed charging point setup, 10% spaces should be EV ready with cable routing (increases by 10% every 5 years)	1% spaces should have installed charging point setup, (increases by 1% every 5 years), 5% spaces should be EV ready with cable routing (increases by 10% every 5 years)
Washington DC	DC	2021	-	20% spaces should be EV ready with cable routing	-
Summit County	CO	2020	Minimum 1 EV ready space per home.	5% EV-Installed, 10% EV-Ready, 40% EV-Capable (10+ spaces)	5% EV-Installed, 10% EV-Ready, 40% EV-Capable (25+ spaces)

Dillon	CO	2020	Minimum 2 EV ready space per home.	5% EV-Installed, 10% EV-Ready, 40% EV-Capable (10+ spaces)	5% EV-Installed, 10% EV-Ready, 40% EV-Capable (25+ spaces)
Breckenridge	CO	2020	Minimum 3 EV ready space per home.	5% EV-Installed, 10% EV-Ready, 40% EV-Capable (10+ spaces)	5% EV-Installed, 10% EV-Ready, 40% EV-Capable (25+ spaces)
Frisco	CO	2020	Minimum 4 EV ready space per home.	5% EV-Installed, 10% EV-Ready, 40% EV-Capable (10+ spaces)	5% EV-Installed, 10% EV-Ready, 40% EV-Capable (25+ spaces)
Salt Lake City (Pending)	UT	2020		20% EV-Capable	
City of Boulder	CO	2020	Minimum 1 EV ready space per home.	5% EV-Installed, 15% EV-Ready, 40% EV-Capable (25+ spaces)	5% EV-Installed, 10% EV-Ready, 10% EV-Capable
Denver	CO	2020	Minimum 1 EV ready space per home.	5% EV-Installed, 15% EV-Ready, 80% EV-Capable	5% EV-Installed, 10% EV-Ready, 10% EV-Capable
Honolulu	HI	2020	Minimum 1 EV capable space per home.	25% EV-Ready (8+ spaces)	25% EV-Ready (12+ spaces)
Chicago	IL	2020		20% EV-Ready (5+ spaces)	20% EV-Ready (30+ spaces)

11.4 Grid integration of EV charging infrastructure

11.4.1 Installation of an EV charger

For connecting EV chargers to the distribution grid, most of the countries analyzed under this study follow similar procedures. Installation of EV chargers is generally not allowed without prior analysis and approval from the relevant DSO/DNO. Different distribution utilities in UK, USA, Netherlands, and Germany have similar procedures for installing private EV chargers, which requires a competent authority first to assess the residential electrical infrastructure and notify the required upgradation/modifications to both the customer and the distribution utility. After the necessary upgrades to the residential electrical connection are made, the DSO would permit EV charger installation.

Different distribution utilities in the UK have are also maintaining a publicly available database on the available margin in the distribution transformers. Prospective EV users and CPOs can utilize this data to plan the location for the installation of EV chargers.

As the increased EV charging load can also warrant upgradation in the distribution grid, different avenues need to be explored for financing these distribution grid upgradations. In this respect, Norway has proposed a plan to modify its existing tariff structure so that the upgradation cost is distributed among the different users under the distribution utility's jurisdiction, as described in Section 8.5.1.

11.4.2 Impact of EV charging on the grid

It has been largely concluded that the impact of EV charging on the annual energy demand would be minimal. However, the impact on the local distribution grid is more prominent.

In USA, considering an optimistic scenario with 15% of the total passenger fleet electrified by 2030, the annual electricity energy required for charging the EV fleet is around 26 TWh as given in Section 3.5. Comparatively the total annual electricity consumed by USA is around 4,194 TWh in by the end of 2019 (IEA, n.d.). Similarly, in Norway, the demand from EVs only accounted for 0.14% of the country's annual electricity demand in 2017. If all of 2.7 million passenger electric vehicles were to be electrified, the additional energy demand in the system due to vehicle charging requirements would about 6.5 TWh, which is 6% of the country's total demand (*Nordic EV Outlook 2018*, 2018). The growth of electricity demand due to EV charging across China, USA and Europe has been given in Figure 11.29, showing that China has a much higher annual electricity demand for EV charging compared to USA and Europe. However, looking at the vehicle segment wise

categorization of charging demand as given in Figure 11.28, the demand to 4W Evs is highest in Europe, followed by USA and then China. The aggressive electrification of the bus fleet in China, has exponentially increased the electricity demand.

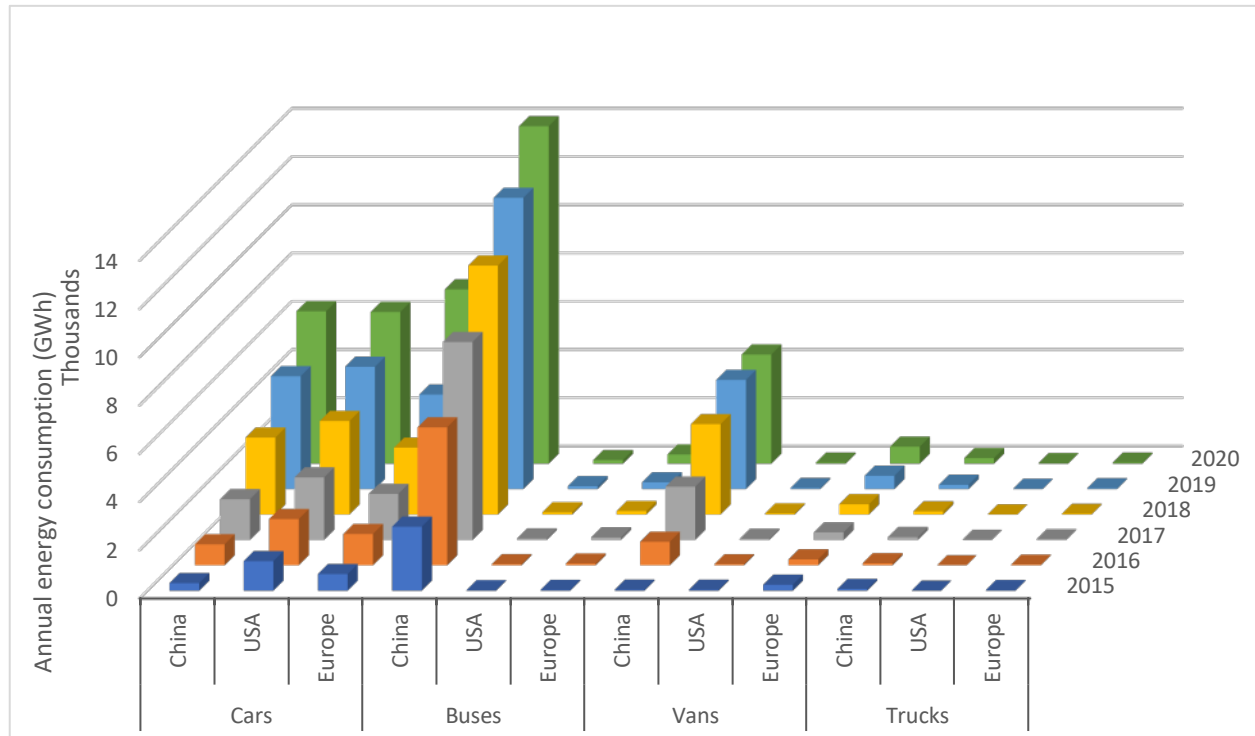

Figure 11.28: Annual electricity demand for EV charging across vehicle segments (IEA, 2021b)

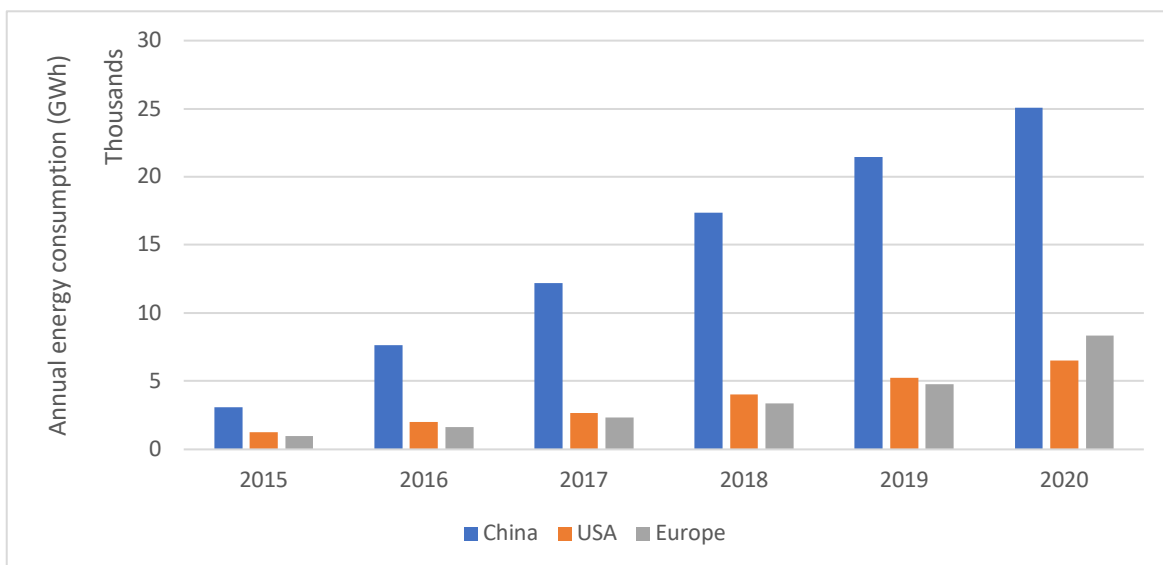

Figure 11.29: Total annual electricity demand for EV charging (IEA, 2021b)

Grid congestion, undervoltage issues, thermal overloading, phase imbalance, harmonic injection are few of the major challenges presented by EV integration to the distribution grid. The severity of the impact is dependent on the number of EVs charging simultaneously as well as the prevalent grid conditions. Some of the impacts of EV integration on distribution system reported in different countries have been summarized below.

- The Norwegian Water Resources and Energy Directorate (NVE) has reported that although a few percent of the transformers are currently operating close to their rating or slightly overloaded, an increase in power consumption by 1-2 kW per household would lead to overload in nearly 10% of all transformers (Jonassen, 2016). Further, if the average power added to each household is 5 kW, then over 30% of the transformers and 10% of high voltage cables would be overloaded (Jonassen, 2016).
- Western Power Distribution (WPD) in UK estimates that most of its larger local transformers will be able to accommodate a 35 kWh charge every 5 days, for each customer connected to it. However, if the requirements exceed this range then alternative solutions would be necessary such as smart charging or grid upgradation (*Electric Vehicle Strategy*, 2020).
- Different pilots and demonstration projects were conducted in the UK, to have a detailed understanding on the impact of EV charging on the distribution grid. One such project is 'My Electric Avenue' project which utilized the real-world usage of 100 volunteers with EV to understand their driving needs and how the distribution grid is impacted during charging periods, as described in Section 2.6.1. The study concluded that the residential EV charging coincides with the traditional evening peak and that increasing penetration of EVs on LV feeders result in both thermal and voltage issues (*My Electric Avenue - Project Close-Down Report*, 2016).
- The RECHARGE project led by the National Renewable Energy Laboratory, in partnership with Sandia National Laboratory and Idaho National Laboratory performed a detailed assessment of EV impacts on the distribution networks of Minneapolis and Atlanta. As per the analysis, EV hosting capacity vary by location as well as feeder type. Distance from the substation is also a key metric in the determination of hosting capacity. Line congestion has been observed as the most common limiting factor which is followed by under-voltage issues (Meintz, 2020).
- To study the impact of high EV penetration on the distribution network, the Swedish state-owned research company Energiforsk conducted a simulation study considering different

end-user scenarios (Sandels & Widén, 2018). This study too, reported undervoltage issues for high EV penetration levels.

11.4.3 Smart Charging, Ancillary Services and RE integration

Smart charging has been widely recognized as a key way forward to not only accommodate higher EV penetration in the distribution system with minimum need for grid upgradation, but it is also being considered as solution to address several issues, such as congestion, voltage issues etc. Moreover, smart charging allows to exploit the potential of underlying battery storage for various grid support services and increased uptake of renewable energy. In light of the importance of smart charging, UK has started rolling out plans and policies in a phased manner to mandate the incorporation of smart charging functionality for all residential chargers. This would enable the DSO or the central management system in coordination with the DSO to control the EV charging load in response to the grid operational parameters. Stromnetz Berlin (grid operator in Berlin) in Germany has devised different charging management systems to coordinate the EV charging load, so that the distribution grid infrastructure is not stressed during peak load periods as described in Section 6.5.3. The State Grid Corporation of China (SGCC) plans to deploy 300,000 EV smart charging stations as part of its smart charging network and has the world's extensive smart charging network linking charge point operator with EV users (Shumin, 2020).

On the other hand, different CPOs and eMSPs in the Netherlands have used smart charging to increase the RE-usage in EV charging. These charging management systems are integrated with the balancing market and, by using the forecast of RE generation, control the EV load to maximize the RE usage. In the past decade, California has seen a massive surge in the rooftop PV sector, which has resulted in the well-known duck curve. To address this issue, the DSOs of California have created time-based tariffs to incentivize EV users to charge their EVs during mid-day when the PV generation is the highest. California also has stand-alone EV chargers that are powered solely by PV without any grid connection. These chargers have been deployed primarily in rural areas to make EVs more attractive to the local population.

Due to their fast response, EVs have been recognized as an ideal source for the provision of ancillary services. Although most countries do not have regulations in place to use EVs as a source of ancillary services, Denmark recently allowed the participation of an aggregated EV fleet to participate in its ancillary services (specifically FCR-N). A few independent system operators (ISO) in the USA have also allowed the participation of EV fleets in its ancillary market. Besides

these, different pilot projects are being carried out in the USA, Denmark, UK, Germany to provide ancillary services from EVs.

11.4.4 Vehicle-to-grid (V2G) application

Several V2G commercial products have been launched in the USA and UK, however, there is a need for conducive regulations for widespread adoption of V2G technology. These include technical regulations on the requirements for bidirectional power flow to the grid from the EV and commercial regulations regarding battery warranty issues, etc. In 2019, Germany announced regulations (VDE-AR-N 4100, VDE-AR-N 4110 and VDE-AR-N 4120) for connecting EV charging facilities to the grid and these regulations included both charging and discharging (feeding power into the grid i.e., V2X applications) of the charging stations.

Different commercial and demonstration pilots are being conducted in UK, USA, Netherlands, and Denmark. A draft regulation for V2G services has also been released in the Netherlands. Different V2G demonstration/pilot projects across the world are marked in Table 11.2

Table 11.2: V2G pilot projects throughout the world (V2G Hub, n.d.)

Country	Few examples
USA	INVENT Los Angeles Air Force Base V2G
UK	Project Sciurus, Electric Nation V2G, e-flex Powerloop
The Netherlands	Amsterdam V2G, Direct Solar DC V2G Hub, City-Zen Project
Denmark	Parker Project
Germany	Redispatch V2G, Vehicle-to-Coffee

Chapter 12. Conclusion and Way Forward

In 2020, the global electric vehicle stock touched the milestone of 10 million which is an increase of 43% over 2019. Although the automobile sector was affected due to economic repercussions of COVID-19, about 3 million electric cars were registered globally (IEA, 2020). This rising number of EVs is a result of various policy measures undertaken by Governments to transition towards cleaner and more sustainable forms of energy for transportation as well as stringent CO₂ emission standards. Parallely, growth in installed power capacity of renewable energy signifies that the world is moving towards decarbonization of the power sector. It must be noted that in 2020, electricity supplied by renewables was the only source of power generation to grow, showing greater resilience than other fossil fuels (REN21, 2021).

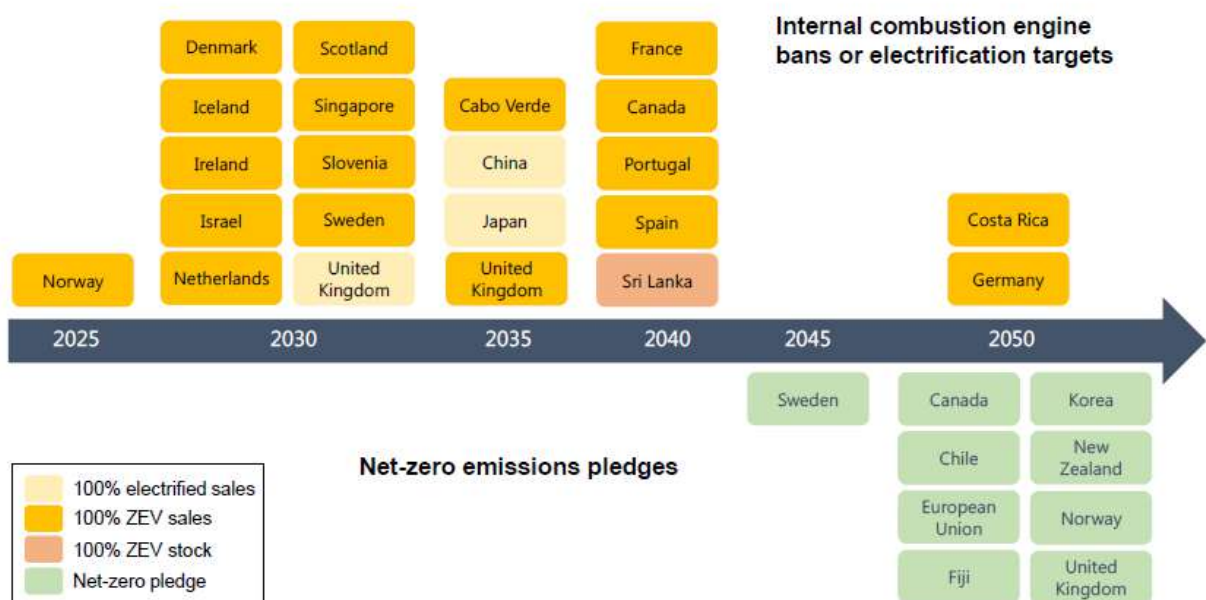

Figure 12.1: Summary of electrification targets, ICE bans and net-zero emissions pledges (IEA, 2021a)

It is imperative to achieve mass adoption of EVs in the next few years to unleash the full potential of electric mobility and build a thriving ecosystem. In this regard, more than 20 countries have electrification targets or ICE bans for cars, while 8 countries and the European Union have announced net-zero pledges (IEA, 2020). This aspect is summarized in the Figure 12.1.

Robust networks of EV charging infrastructure must be developed across the world to cater to the ever-growing number of EVs. Countries across the globe have announced various fiscal and non-fiscal incentives to augment larger interconnected networks of EV charging infrastructure. In most countries, the EV charging infrastructure started with slow EV chargers with lower power

capacities. However, this was because when these charging infrastructures were installed, the availability of EV models with fast charging capability was limited due to technical limitation. With development in battery technology, high energy and power density batteries are being used in the recent EV models. This resulted in the rapid growth of the fast-charging infrastructure internationally. In the studied countries, it has been observed that chargers rated 7-22 kW have been the most prevalent till date. But, since the last few years, rapid chargers with rated power of above 50 kW have also seen high growth levels.

Although the electricity for charging EVs accounts for only about 1% of current electricity total final consumption worldwide, integration of EV charging infrastructure with the power grid entails many challenges. These challenges are more pronounced for the distribution system. Network congestion, voltage issues, increase in peak load, phase imbalance issues are just a few of the many different challenges that have been witnessed by distribution utilities with high EV loads. Further, installation of these high-power chargers may warrant upgradation of the distribution infrastructure, which may significantly increase the capital expenditure. In this respect, implementation of smart charging is a key enabler to ensure EV uptake is not constrained by grid capacity. Smart charging would enable the distribution utility to control the EV load, thereby helping them shift the charging load to off-peak periods, which could help in deferring grid upgradation requirements. Along with leveling the load, smart charging would help in increasing the utilization of renewable energy for EV charging.

It is estimated that presently, BEVs provide lifecycle GHG emissions reductions of about 20-30% as compared to ICE vehicles on a global average. These reductions are more pronounced in countries where power generation mix is rapidly decarbonizing (IEA, 2020). With more renewable power being added to the grid annually in the past seven years, than the combined total of power produced from fossil fuels and nuclear power, we can see that we are positively heading towards decarbonizing the power sector (IRENA, 2021). With e-mobility paving the way for effective sector coupling between the transport and the energy sector, this synergistic approach is leading the world towards a decarbonized future.

India had pledged to reduce its carbon footprint by 33-35% by 2030 below 2005 levels at COP21 summit and also pledged to increase the share of non-fossil fuels-based electricity to 40% by 2030. At this juncture, we can see that Government of India has taken crucial steps towards faster adoption of EVs through policy and regulatory measures. In this light, the aim of this report is to provide insights to Policy makers, Regulators, Utilities, OEMs and other value chain players on the global best practices which could help them in formulating customized solutions for the

challenges faced in integrating EVs with the grid in India. Without directly emulating the practices followed in international countries, it is important for the stakeholders to take inspiration from them and formulate policies and regulations which are most suited for the Indian EV ecosystem. The next report in this series “*Report-3: Status Quo of Electric Vehicle Charging Infrastructure and Grid Integration in India*” would disseminate knowledge on status quo analysis of EV charging infrastructure, its grid integration, policy and regulatory aspects, and EV charging tender analysis in India.

References

- 3connect. (2021). <http://www.3connect-projekt.de/home/>
- A suitable connection for electric driving. (n.d.). Liander. <https://www.liander.nl/consument/aansluitingen/elektrisch-rijden>
- ABB. (n.d.). *European Long-distance Electric Clean Transport Road Infrastructure Corridor (ELECTRIC)*.
- Afdc. (2021). *Alternative Fuels Data Center: Electric Vehicle Charging Station Locations*. US Department of Energy - Alternative Fuels Data Center. https://afdc.energy.gov/fuels/electricity_locations.html#/find/nearest?fuel=ELEC
- Alternative, E., & Observatory, F. (2018). *The evolution of public EV charging*.
- Andersen, P. B., Toghroljerdi, S. H., Meier, T., Christensen, B. E., Christian, J., Lodberg, M., Olesen, O. J., & Due, A. (2019). *Parker Project Final Report. Energy Technology Development and Demonstration Program (EUDP)*.
- Andersen, P. B., Toghroljerdi, S. H., Sorensen, T. M., Christensen, B. E., Høj, J. C. M., Lodberg, J. R., & Zecchino, A. (2019). *The Parker Project: Final report appendices*. <https://parker-project.com/#downloads>
- Andersen, U. (n.d.). *In three years buildings shall be made ready for charging electric cars*. Energy City, Frederikshavn Municipality. Retrieved April 16, 2021, from <http://energycity.dk/news/three-years-buildings-shall-be-made-ready-charging-electric-cars>
- Arias, N. B., Hashemi, S., Andersen, P. B., Traholt, C., & Romero, R. (2018). V2G enabled EVs providing frequency containment reserves: Field results. *Proceedings of the IEEE International Conference on Industrial Technology, 2018-Febru, 1814–1819*. <https://doi.org/10.1109/ICIT.2018.8352459>
- Bass, R. B., & Zimmerman, N. (2013). *Impacts of Electric Vehicle Charging on Electric Power Distribution Systems*. Portland State University Library. <https://doi.org/10.15760/trec.145>
- BBC News. (2014, June). *Only 3% of mayor's target met on electric vehicles*. <https://www.bbc.com/news/uk-england-london-27955893>
- Bhagwat, P. C., Hadush, S. Y., & Bhagwat, S. (2019). *Charging up India's electric vehicles: Infrastructure deployment and power system integration*. European University Institute.
- Bilparken,. (n.d.). Statistik Sentralbyra. Retrieved February 15, 2021, from <https://www.ssb.no/transport-og-reiseliv/statistikker/bilreg>
- Binding, C., Gantenbein, D., Jansen, B., Sundström, O., Andersen, P. B., Marra, F., Poulsen, B., & Træholt, C. (2010). Electric vehicle fleet integration in the Danish EDISON project—A virtual power plant on the island of Bornholm. *IEEE PES General Meeting, PES 2010*. <https://doi.org/10.1109/PES.2010.5589605>
- Black, D., Macdonald, J., Deforest, N., & Gehbauer, C. (2018). *Los Angeles Air Force Base Vehicle-to-Grid Demonstration* (Issue October).
- Bloomberg. (2021, June 27). *China's electric car capital has lessons for the rest of the world*. Hindustan Times Auto News. <https://auto.hindustantimes.com/auto/news/chinas-electric-car-capital-has-lessons-for-the-rest-of-the-world-41624767968331.html>
- Boverket. (2019). *New requirements for charging infrastructure for charging vehicles*. <https://www.boverket.se/sv/om-boverket/publicerat-av-boverket/publikationer/2019/nya-krav-pa-laddinfrastruktur-for-laddfordon/>

- Bundestag, G. (2019). Smart Charging System for Electric Vehicles. In *National Conference on Innovation in Electrical Power and Energy Systems (NCIEPES-19)*, M.Kumarasamy College of Engineering and Technology, Karur.
- C2ES (The Center for Climate and Energy Solutions). (2019). *US State Clean Vehicle Policies and Incentives*. <https://www.c2es.org/document/us-state-clean-vehicle-policies-and-incentives/>
- Calvillo, C. F., & Turner, K. (2020). Analysing the impacts of a large-scale EV rollout in the UK – How can we better inform environmental and climate policy? *Energy Strategy Reviews*, 30(December 2019), 100497. <https://doi.org/10.1016/j.esr.2020.100497>
- Cazzola, P., Gorner, M., Scheffer, S., Scuitmaker, R., & Tattini, J. (2018). *Nordic EV Outlook 2018: Insights from leaders in electric mobility*. International Energy Agency. <https://webstore.iea.org/nordic-ev-outlook-2018>
- CCET. (2015). Technology Solutions for Wind Integration in ERCOT. In *U. S. Department of Energy (DE-OE0000194)*. Center for the Commercialization of Electric Technologies (CCET). https://www.smartgrid.gov/files/documents/CCET-SGDP-FTR_Feb_2015.pdf
- Cenex. (2021). *Project Sciurus trial insights: Findings from 300 domestic V2G units in 2020*. <https://www.cenex.co.uk/app/uploads/2021/05/Sciurus-Trial-Insights.pdf>
- CHAdEMO. (n.d.). *CHAdEMO 3.0 released: The first publication of ChaoJi, the new plug harmonised with China's GB/T – Chademo Association*. <https://www.chademo.com/chademo-3-0-released/>
- Charging management system*. (n.d.). Stromnetz Berlin. <https://www.stromnetz.berlin/en/electric-mobility/charging-management-system>
- Charles Morris. (2021, June 29). *California Needs 1.2 Million Public Chargers by 2030, According to New Electric Vehicle Report*. EVANNEX Aftermarket Tesla Accessories. <https://evannex.com/blogs/news/california-will-need-1-2-million-public-chargers-by-2030-says-a-new-report>
- Chen, X., Zhang, H., Xu, Z., Nielsen, C. P., Mcelroy, M. B., & Lv, J. (2018). Impacts of fleet types and charging modes for electric vehicles on emissions under different penetrations of wind power Xinyu. *Nature Energy*, 3(May 2018). <https://doi.org/10.1038/s41560-018-0133-0>
- Christensen, B. E. (2018). We Make Electric Vehicles Greener ... and less expensive. *INVENT*.
- Coignard, B. J., & Macdougall, P. (2019). Will Electric Vehicles Drive Distribution Grid Upgrades? *IEEE Electrification Magazine*, June 2019, 46–56.
- Coignard, J., Macdougall, P., Stadtmueller, F., & Vrettos, E. (2019). Will electric vehicles drive distribution grid upgrades? *IEEE Electrification Magazine*.
- Consultation, A., Accessibility, P., & Metropolitan, A. (2016). *C-198 Electric Transport Green Deal 2016-2020*. 1–12.
- Cui, H., Hall, D., & Lutsey, N. (2020). *Update on the global transition to electric vehicles through 2019*. ICCT. <https://theicct.org/sites/default/files/publications/update-global-EV-stats-20200713-EN.pdf>
- DBI. (2021). *De danske bilimportorer*. <https://www.bilimp.dk/omdbi/>
- Denning, L., & He, E. (2021). *When the Electric Car Is King, Less Energy Is More*. Bloomberg. https://www.bloomberg.com/graphics/2021-opinion-renewables-will-power-future-of-us-energy/?cmpid=socialflow-facebook-business&utm_medium=social&utm_source=facebook&utm_content=business&utm_campaign=socialflow-organic

- DG-IPOL. (2018). *Research for TRAN Committee—Charging infrastructure for electric road vehicles*.
- EAFO. (2021). *European Alternative Fuels Observatory | Germany*.
<https://www.eafo.eu/alternative-fuels/electricity/charging-infra-stats#>
- ElaadNL. (2019a). Charging Stations: Requirements for bidirectional systems. In *ElaadNL* (Issue december). <http://electricvehicles.caa.ca/types-of-electric-vehicles/charging-stations/>
- ElaadNL. (2019b). *Security architecture for electric vehicle charging infrastructure*.
- Electreon. (n.d.). Retrieved February 19, 2021, from <https://www.electreon.com/technology>
- Electric Nation. (n.d.). *Powered up: Charging EVs without stressing the electricity network*.
<https://www.electricnation.org.uk/wp-content/uploads/2019/10/Electric-Nation-Powered-Up-Report-WEB.pdf>
- Electric Nation: Vehicle to Grid*. (n.d.). Retrieved February 17, 2021, from <https://electricnation.org.uk/>
- Electric Program Investment Charge (EPIC) Submetering for EVs to Increase Customer Billing Flexibility*. (2019). Pacific Gas and Electric Company.
- Electric Vehicle Smart Charging*. (2019). HM Government Department for Transport.
<https://www.gov.uk/government/consultations/electric-vehicle-smart-charging>
- Electric vehicle strategy* (Issue April). (2020).
- Electric Vehicles*. (n.d.). San Diego Gas & Electric. <https://www.sdge.com/residential/lovelectric>
- Elfrink, F., Eijdsen, B. van, Oudshoorn, Q., Pierik, S., Channoullis, G., & Papadopoulos, N. (2017). *Final report Pilot Wireless Charging—Rotterdam*.
- EPRI. (2016). JUMPSmartMaui Demonstration Project Phase 1 Assessment. In *Electric Power Research Institute* (Issue March).
- Eriksen, A. B., & Mook, V. (2020). *Proposed changes to the design of network tariffs for low voltage grid users in Norway*. The Norwegian Energy Regulatory Authority (RME).
https://publikasjoner.nve.no/rme_rapport/2020/rme_rapport2020_02.pdf
- ERoadArlanda. (n.d.). *About the project*. Retrieved February 25, 2021, from <https://eroadarlanda.com/about-the-project/>
- Regulation (EU) 2016/679 of the European Parliament and of the Council of 27 April 2016 on the protection of natural persons with regard to the processing of personal data and on the free movement of such data, and repealing Directive 95/46/EC (General Data Protection Regulation) (2016).
- EV capacity map application*. (2019). Western Power Distribution.
<https://www.westernpower.co.uk/ev-capacity-map-application>
- Ev power—Overview*. (n.d.). GridServe. Retrieved February 17, 2021, from <https://www.gridserve.com/ev-power-overview/>
- Fearnley, N., Pfaffenbichler, P., Figenbaum, E., & Jellinek, R. (2015). *E-vehicle policies and incentives—Assessment and recommendations. Summary*. Institute of Transport Economics Norwegian Centre for Transport Research.
<https://www.toi.no/getfile.php?mmfileid=41187>
- Gadh, R. (2018). *Demonstrating Plug-in Electric Vehicles Smart Charging and Storage Supporting the Grid* (Issue August). California Energy Commission.

- GCR. (2020). *V2G company Nuvve participating in California's wholesale energy markets to help balance the grid—Green Car Congress*. Green Car Congress. <https://www.greencarcongress.com/2020/09/20200920-nuue.html>
- Glachant, J., & Rossetto, N. (2018). *The digital world knocks at Electricity's door: Six building blocks to understand wh.*
- Gnann, T., Ploetz, P., & Wietschel, M. (2015). How to address the chicken-egg-problem of electric vehicles? Introducing an interaction market diffusion model for EVs and charging infrastructure. *Proceedings of the 2015 ECEEE Summer Study*.
- Gnann, T., Stephens, T. S., Lin, Z., Plötz, P., Liu, C., & Brokate, J. (2018). What drives the market for plug-in electric vehicles? - A review of international PEV market diffusion models. *Renewable and Sustainable Energy Reviews*, 93, 158–164. <https://doi.org/10.1016/j.rser.2018.03.055>
- Gov.UK. (2012, January). *Press release: Plug-in car grant extended to vans*. <https://www.gov.uk/government/news/plug-in-car-grant-extended-to-vans>
- Gov.uk. (2015). *Uptake of ultra low emission vehicles in the UK*. Brooklyndhurst. https://assets.publishing.service.gov.uk/government/uploads/system/uploads/attachment_data/file/464763/uptake-of-ulev-uk.pdf
- GOV.UK. (2019, July 15). *Electric vehicle chargepoints in residential and non-residential buildings*. <https://www.gov.uk/government/consultations/electric-vehicle-chargepoints-in-residential-and-non-residential-buildings>
- GOV.UK. (2021). *£20 million fund fuels search for electric vehicle innovations*. <https://www.gov.uk/government/news/20-million-fund-fuels-search-for-electric-vehicle-innovations>
- Hall, D., & Lutsey, N. (2017). Emerging best practices for electric vehicle charging infrastructure. In *ICCT White Paper*.
- Hall, D., & Lutsey, N. (2020). *Electric vehicle charging guide for cities*. ICCT. https://theicct.org/sites/default/files/publications/EV_charging_guide_03162020.pdf
- Hanemann, P., Behnert, M., & Bruckner, T. (2017). Effects of electric vehicle charging strategies on the German power system. *Applied Energy*, 203, 608–622. <https://doi.org/10.1016/j.apenergy.2017.06.039>
- Haugneland, P. (n.d.). *Over 200.000 elbiler i Norge | Norsk elbilforening*. Retrieved February 13, 2021, from <https://elbil.no/over-200-000-elbiler-i-norge/>
- Helmus, J. R., Spoelstra, J. C., Refa, N., Lees, M., & van den Hoed, R. (2018). Assessment of public charging infrastructure push and pull rollout strategies: The case of the Netherlands. *Energy Policy*, 121, 35–47. <https://doi.org/10.1016/j.enpol.2018.06.011>
- Hertzke, P., Müller, N., Schaufuss, P., Schenk, S., & Wu, T. (2019). Expanding electric-vehicle adoption despite early growing pains. *McKinsey Center for Future Mobility*, August.
- Hertzke, P., Müller, N., & Schenk, S. (2020). *THE GLOBAL ELECTRIC-VEHICLE MARKET IS AMPED UP AND ON THE*. 1–8.
- Hildermeier, B. J., Kolokathis, C., Rosenow, J., Hogan, M., Wiese, C., & Jahn, A. (n.d.). *Start with smart*.
- Hinweise für Ladeeinrichtungen (Wallboxen) für Elektrofahrzeuge in Einzelgaragen*. (n.d.).
- HM Government. (n.d.). *Transitioning to zero emission cars and vans: 2035 delivery plan*. https://assets.publishing.service.gov.uk/government/uploads/system/uploads/attachment_data/file/1005301/transitioning-to-zero-emission-cars-vans-2035-delivery-plan.pdf

- Hove, A., & Sandalow, D. (2019). *Electric vehicle charging in China and the United States* (Issue February).
- Hybrid and Electric Vehicles The Electric Drive Hauls*. (2019). IEA. <http://www.ieahev.org/news/annual-reports/>
- Hybrid-Electric, Plug-in Hybrid-Electric and Electric Vehicle Sales*. (2020). Bureau of Transportation Statistics. <https://www.bts.gov/content/gasoline-hybrid-and-electric-vehicle-sales>
- ICCT. (2020). *Regional charging infrastructure requirements in Germany through 2030*. <https://theicct.org/sites/default/files/publications/germany-charging-infrastructure-20201021.pdf>
- ICCT. (2021). *China's New Energy Vehicle Industrial Development Plan for 2021 to 2035*. <https://theicct.org/sites/default/files/publications/China-new-vehicle-industrial-dev-plan-jun2021.pdf>
- IEA. (n.d.). *Fuels and technologies: Electricity*. <https://www.iea.org/fuels-and-technologies/electricity>
- IEA. (2019). *Global EV Outlook 2019—Scaling-up the transition to electric mobility*.
- IEA. (2020). *Global EV Outlook 2020*. <https://doi.org/10.1787/d394399e-en>
- IEA. (2021a). *Global EV Outlook 2021*.
- IEA. (2021b, April 29). *Global EV data explorer*. <https://www.iea.org/articles/global-ev-data-explorer>
- InterFlex. (2020). *Project Summary January 2017 December 2019. December 2019*.
- International Energy Agency. (2019). *Global EV Outlook 2019 to electric mobility*.
- International, I. E. A., & Agency, E. (2018). *Global EV Outlook 2018*.
- International Renewable Energy Agency (IRENA). (2019). *Global Energy Transformation (GET): A Roadmap to 2050*. In *Global Energy Transformation. A Roadmap to 2050*.
- INTERPLAN. (2018). *Technical assessment and regulatory status of the European electricity grid*. INTEGrated operation PLANning tool towards the Pan-European Network. <https://ec.europa.eu/research/participants/documents/downloadPublic?documentIds=080166e5ba58a0d8&appld=PPGMS>
- IRENA. (2021). *World Energy Transitions Outlook: 1.5°C Pathway*. y, International Renewable Energy Agency, Abu Dhabi. https://www.irena.org/-/media/Files/IRENA/Agency/Publication/2021/March/IRENA_World_Energy_Transitions_Outlook_2021.pdf
- Irie, H. (2017). *Japan—U.S. Collaborative Smart Grid Demonstration Project in Maui Island of Hawaii State:A case study*.
- ISGF. (2019). *Electric Vehicle Policies and Electricity Tariff for EV Charging in India*. July.
- Jedlix. (2021). *Jedlix | Smart Charging*. <https://www.jedlix.com/en/how-jedlix-works/>
- Jochem, P., Kaschub, T., Paetz, A. G., & Fichtner, W. (2012). Integrating electric vehicles into the german electricity grid—An interdisciplinary analysis. *World Electric Vehicle Journal*, 5(3), 763–770. <https://doi.org/10.3390/wevj5030763>
- Jonassen, T. (2016). *Status of NVE's work on network tariffs in the electricity distribution system* (Jonassen_norway, Ed.). Norges vassdrags- og energidirektorat.

- Meeus, L. (2017). *My take on electric vehicle charging infrastructure debate*. Florence School of Regulation.
- Meintz, A. (2020). Charging Infrastructure Technologies: Smart Electric Vehicle Charging for a Reliable and Resilient Grid (RECHARGE). *DOE Vehicle Technologies Program, 2020 Annual Merit Review and Peer Evaluation Meeting*.
- Metering of the charging process*. (n.d.). Stromnetz. <https://www.stromnetz.berlin/en/electric-mobility/metering-of-charging-process>
- Middleton, N. (2021, March 10). *Government's £20m fund to drive electric vehicle innovations*. The Great British Fleet Event. <https://greatbritishfleetevent.co.uk/governments-20m-fund-to-drive-electric-vehicle-innovations/>
- Ministry of Economic Affairs. (2020). *Vision on the charging infrastructure for electric transport*.
- Moreno, A. I. (n.d.). *E-mobility in Germany: Analysis of electric vehicle charging stations*. Towards Data Science. <https://towardsdatascience.com/e-mobility-in-germany-analysis-of-electric-vehicle-charging-stations-58d797988738>
- Mulvaney, D. (2019). Green New Deal. *Solar Power*, 47–65. <https://doi.org/10.2307/j.ctvd1c6zh.7>
- My Electric Avenue—Project Close-Down Report* (Issue March). (2016).
- Navigant, Elektromobilität Kompetenzzentrum, & RE-xpertise. (2019). *Distribution grid planning for a successful energy transition – focus on electromobility*. October, 100.
- NEA. (n.d.). *New buildings must meet BENG requirements*. Business.Gov.Nl. <https://business.gov.nl/amendment/new-buildings-beng-energy-efficiency-requirements/>
- NEA. (2019). *Electric vehicle charging: Definitions and explanation*. Netherlands Enterprise Agency. https://www.rvo.nl/sites/default/files/2019/01/Electric%20Vehicle%20Charging%20-%20Definitions%20and%20Explanation%20-%20january%202019_0.pdf
- NEA. (2021). *Electric vehicle statistics in the Netherlands*. Netherlands Enterprise Agency. <https://www.rvo.nl/sites/default/files/2021/07/Statistics%20Electric%20Vehicles%20and%20Charging%20in%20The%20Netherlands%20up%20to%20and%20including%20June%202021.pdf>
- Nicholas, M., & Lutsey, N. (2020). *Quantifying the electric vehicle charging infrastructure gap in the United Kingdom*.
- Nordic EV Outlook 2018*. (2018).
- Norway. (n.d.). European Alternative Fuels Observatory. Retrieved February 24, 2021, from <https://www.eafo.eu/countries/norway/1747/summary>
- Number of electric cars and charging stations in Norway | Norwegian Electric Car Association*. (n.d.). Retrieved February 13, 2021, from <https://elbil.no/elbilstatistikk/>
- NUVVE. (n.d.). *V1G+V2G Charging Stations*. Retrieved February 17, 2021, from <https://nuvve.com/chargers/>
- Nyregistreringar*. (2021). BIL Sweden. <https://www.bilsweden.se/statistik/nyregistreringar>
- Octopus Energy. (n.d.). *Octopus Agile*. https://octopus.energy/agile/?utm_medium=website&utm_source=tarrif&utm_campaign=agile
- Octopus Go. (n.d.). Octopus Energy. Retrieved February 17, 2021, from https://octopus.energy/go/?utm_medium=website&utm_source=tarrif&utm_campaign=go

- Ofgem. (2018). Implications of the transition to Electric Vehicles. *Future Insights Series*, 31.
- OPTIMAX PowerFit. (2017). ABB.
- Pacific Gas and Electric Company. (2018). *Test Smart Inverter Enhanced Capabilities – Vehicle to Home*. Pacific Gas and Electric Company.
- PAS 1878: 2021 , *Energy smart appliances – Classification – Specification*. (2020). BSI. <https://standardsdevelopment.bsigroup.com/projects/2019-01576#/section>
- Perkowski, J. (2016, September). The Electric Car Market Has A “Chicken Or Egg” Problem— And China Is Solving It. *Forbes*.
- PG&E. (2016a). *Develop a Tool to Map the Preferred Locations for DC Fast Charging, Based on Traffic Patterns and PG&E’s Distribution System, to Address EV Drivers’ Needs While Reducing the Impact on PG&E’s Distribution Grid*. Pacific Gas and Electric Company.
- PG&E. (2016b). *EPIC 1.16 – Demonstrate electric vehicle as a resource to improve grid power quality and reduce customer outages*.
- PJM. (2021). *PJM Manual 11: Energy & ancillary services market operations*.
- Powerloop-V2G. (n.d.). Octopus Electric Vehicles. Retrieved February 17, 2021, from <https://www.octopusev.com/powerloop-old>
- PUBLICLY AVAILABLE SPECIFICATION PAS 1879: 2021 , *Energy smart appliances – Demand side response operation – Code of practice*. (2020). BSI.
- Ramboll. (2019). *Ancillary Services From New Technologies Technical Potentials and* (Issue December).
- Rate Options for Clean Energy Technology*. (n.d.). SCE. <https://www.sce.com/residential/rates/electric-vehicle-plans>
- Refa, N., & Hubbers, N. (2019). Impact of Smart Charging on EVs Charging Behaviour Assessed from Real Charging Events. *32nd Electric Vehicle Symposium (EVS32)*, 1–10.
- REN21. (2021). *Renewables in Cities 2021 Global Status Report*. (Paris: REN21 Secretariat).
- Reuters. (2021, February 7). *Germany will have 1 million electric cars on the road in July*. Autoblog. <https://www.autoblog.com/2021/07/02/germany-1-million-electric-cars-on-the-road/>
- RVO, N. E. A. (2020). Statistics Electric Vehicles in the Netherlands. *Procedia Computer Science*, 52(May), 2–5.
- Sadeghianpourhamami, N., Refa, N., Strobbe, M., & Develder, C. (2018). Quantitative analysis of electric vehicle flexibility: A data-driven approach. *International Journal of Electrical Power and Energy Systems*, 95, 451–462. <https://doi.org/10.1016/j.ijepes.2017.09.007>
- Sandels, C., & Widén, J. (2018). *End-user scenarios and their impact on distribution system operators. A techno-economic analysis. Report 2018:508*. Energiforsk AB. <https://energiforskmedia.blob.core.windows.net/media/24750/end-user-scenarios-and-their-impact-on-distribution-system-operators-energiforskrappport-2018-508.pdf>
- Shumin, L. (2020, November 20). *China’s State Grid to add 300,000 new EV charging piles to world’s biggest network*. Yicai. <https://www.yicaiglobal.com/news/china-state-grid-to-add-300000-new-ev-charging-piles-to-world-biggest-network>
- Smart charging stations for a more sustainable grid—Vattenfall*. (n.d.). <https://group.vattenfall.com/press-and-media/newsroom/2020/smart-charging-stations-for-a-more-sustainable-grid>

- Smartroad Gotland*. (n.d.). Retrieved February 15, 2021, from <https://www.smartroadgotland.com/>
- State of Colorado. (2019). *Electric motor vehicles public utility services—Senate bill 19-077*. <https://leg.colorado.gov/bills/sb19-077>
- Statistikk*. (2021). NOBIL. <https://info.nobil.no/statistikk>
- Stéphane Laporte, Gérard Coquery, Virginie Deniau, Alexandre de Bernardinis, & Nicolas Hautiere. (2019). Dynamic Wireless Power Transfer Charging Infrastructure for Future EVs: From Experimental Track to Real Circulated Roads Demonstrations. *World Electric Vehicle Journal, MDPI*, 10(4). <https://doi.org/10.3390/wevj10040084>
- Sweden. (2021). European Alternative Fuels Observatory. <https://www.eafo.eu/countries/sweden/1755/infrastructure/electricity>
- SWEEP. (n.d.). *EV Infrastructure Building Codes: Adoption Toolkit*. Southwest Energy Efficiency Project. <https://www.swenergy.org/transportation/electric-vehicles/building-codes>
- Tene, O., & Polenetsky, J. (2013). Big Data for All: Privacy and User Control in the Age of Analytics. *Northwestern Journal of Technology and Intellectual Property*. https://doi.org/10.1007/978-3-642-12275-0_39
- Teslarati. (n.d.). *Tesla News, Tips, Rumors, and Reviews*. <https://www.teslarati.com/>
- Transport and Environment. (2018). *Roll-out of public EV charging infrastructure in the EU: Is the chicken and egg dilemma resolved?*
- Triple E. (2014). *The Balance of Power – Flexibility Options for the Dutch Electricity Market Final Report*. 1–90.
- United Kingdom. (2021). European Alternative Fuels Observatory. <https://www.eafo.eu/countries/united-kingdom/1758/summary>
- US Drive. (2019). *Summary Report on EVs at Scale and the U. S. Electric Power System* (Issue November 2019).
- USA.gov. (2019). *Alternative Fuels Data Center: Maps and Data—U.S. HEV Sales by Model*. US Department of Energy. <https://afdc.energy.gov/data/>
- USA.gov. (2020). *Alternative Fuels Data Center: Maps and Data—Light-Duty AFV, HEV, and Diesel Model Offerings, by Technology/Fuel*. US Department of Energy. <https://afdc.energy.gov/data/10303>
- USA.gov. (2021). *Alternative Fuels Data Center: Electric Vehicle Charging Station Locations*. US Department of Energy. https://afdc.energy.gov/fuels/electricity_locations.html#/find/nearest?fuel=ELEC
- Use of Street Lighting for Electric Vehicle Charging*. (2019).
- Vattenfall. (n.d.). *With Voordeelladen, electric driving is extra attractive*. <https://www.vattenfall.nl/producten/energie/aanbiedingen/voordeelladen/?campaignName=VattenfallINL+Purpose+to+Market&propositionId=z3zSVzu4NxVehqfgJQ4wgAyA%2F0jelEsDjSSKOrCKcTZx8jyefs4dQLKhRfAxk62vILK%2BDVA7XsoDqmUekH7g%2BQ%3D%3D&house-number-suffix=&check>
- Vaughan, A. (2020, November). *UK 10-point climate plan bans new petrol and diesel car sales by 2030*. New Scientist. <https://www.newscientist.com/article/2260042-uk-10-point-climate-plan-bans-new-petrol-and-diesel-car-sales-by-2030/>
- Vehicle statistics*. (2020). Transport Analysis. <https://www.trafa.se/en/road-traffic/vehicle-statistics/>

- Vehicles statistics*. (2020). GOV.UK. <https://www.gov.uk/government/collections/vehicles-statistics>
- Weckx, S., & Driesen, J. (2015). Load Balancing With EV Chargers and PV Inverters in Unbalanced Distribution Grids. *IEEE Transactions on Smart Grid*, 6(2).
- Your Guide to Electric Vehicle Charging*. (2019). Northern Powergrid. <https://www.northernpowergrid.com/asset/0/document/5486.pdf>
- Zap-Map. (2020). *EV Charging Survey Key Findings 2020*.
- Zap-Map. (2021). *How many charge points are there in the UK 2020*. <https://www.zap-map.com/statistics/#points>
- Zero Emission Vehicle and Infrastructure Statistics*. (n.d.). State of California Energy Commission. Retrieved February 19, 2021, from <https://www.energy.ca.gov/data-reports/energy-insights/zero-emission-vehicle-and-charger-statistics>
- Zhang, K., Xu, L., Ouyang, M., Wang, H., Lu, L., Li, J., & Li, Z. (2014). Optimal decentralized valley-filling charging strategy for electric vehicles. *Energy Conversion and Management*, 78, 537–550. <https://doi.org/10.1016/j.enconman.2013.11.011>

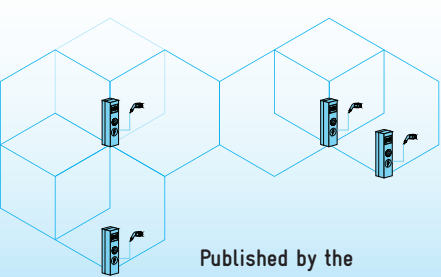

Published by the
Deutsche Gesellschaft für Internationale Zusammenarbeit (GIZ) GmbH

On the behalf of
German Federal Ministry for the Environment, Nature Conservation and
Nuclear Safety (BMU)

Registered offices

Bonn and Eschborn
NDC Transport Initiative for Asia (NDC-TIA) – India component
GIZ Office
B-5/2; Safdarjung Enclave
New Delhi-110029
INDIA
T +91 11 49495353
F +91 11 49495391
I <http://www.giz.de/india>

As of July 2021, New Delhi

Responsible:

Dr. Indradip Mitra
Country Coordinator for NDC-TIA India Component (GIZ)

Project Team:

GIZ: Ms. Sahana L, Ms. Shweta Kalia, Mr. Sudhanshu Mishra,
Mr. Sushovan Bej
IIT Bombay: Prof. Rangan Banerjee, Prof. Zakir Rather, Mr. Angshu
Nath, Ms. Payal Dahiwal, Ms. Dhanuja Lekshmi, Mr. Soudipan Maity
FSR Global: Ms. Swetha Bhagwat, Ms. Christine Juta
DTU: Prof. Qiuwei Wu
IIT Comillas: Prof. Pablo Frias
Cardiff University: Prof. Liana Cipcigan

Authors:

Prof. Zakir Rather (IIT Bombay), Mr. Angshu Nath (IIT Bombay),
Prof. Rangan Banerjee (IIT Bombay), and Ms. Christine Juta (FSR
Global)

Contributors for this report:

Mr. Soudipan Maity (IIT Bombay), Ms. Dhanuja Lekshmi (IIT Bombay),
Mr. Swapnil Gandhi (IIT Bombay) and Ms. Swetha Bhagwat (FSR
Global)

Advisors:

Prof. Liana Cipcigan (Cardiff University, UK), Prof. Qiuwei Wu
(Technical University of Denmark (DTU), Denmark), Prof. Pablo Frias
(IIT Comillas, Spain)

Reviewers:

Ms. Sahana L (GIZ), Ms. Shweta Kalia (GIZ), Mr. Sudhanshu Mishra
(GIZ), Mr. Sushovan Bej (GIZ), Mr. Vijay Kumar (NITI Aayog),
Mr. Siddharth Sinha (NITI Aayog), Mr. Madhav Sharma (NITI Aayog),
Mr. Amit Bhatt (WRI) and Dr. Nibedita Dash (ICCT)

Designer:

Mr. Trinankur Banerjee

Photo credits/sources:

GIZ GmbH and IIT Bombay

